

UNITED STATES DISTRICT COURT  
DISTRICT OF CONNECTICUT

EDDIE GRANT, JR., JENNIFER HAMILTON;  
MICHAEL STIEFEL; CONNECTICUT  
CITIZENS DEFENSE LEAGUE, INC.; AND  
SECOND AMENDMENT FOUNDATION, INC.,

Plaintiffs,

v.

EDWARD M. LAMONT, JR., in his official capacity;  
JAMES ROVELLA, in his official capacity;  
PATRICK GRIFFIN, in his official capacity;  
MARGARET E. KELLY, in her official capacity;  
DAVID R. APPLGATE, in his official capacity;  
JOSEPH T. CORRADINO, in his official capacity;  
SHARMESE L. WALCOTT, in her official capacity;  
DAVID R. SHANNON, in his official capacity;  
MICHAEL A. GAILOR, in his official capacity;  
CHRISTIAN WATSON, in his official capacity;  
JOHN P. DOYLE, JR., in his official capacity, PAUL  
J. NARDUCCI, in his official capacity; PAUL J.  
FERENCEK, in his official capacity; MATTHEW C.  
GEDANSKY, in his official capacity, MAUREEN  
PLATT, in her official capacity; ANNE F.  
MAHONEY, in her official capacity,

Defendants.

CIV. NO. 3:22-cv-01223-JBA

February 3, 2023

**EMERGENCY MOTION**  
**FOR A TEMPORARY**  
**RESTRAINING ORDER**  
**AND A PRELIMINARY**  
**INJUNCTION**

Pursuant to Fed. R. Civ. P. 65 and D. Conn. Local Rule 7, the Plaintiffs hereby respectfully moves the Court to issue an emergency temporary restraining order and preliminary injunction against the Defendants. They request the following relief:

**ORAL ARGUMENT REQUESTED**

1. A temporary restraining order barring the Defendants from enforcing Conn. Gen. Stat. §§ 53-202a, 53-202b, and 53-202c until the Court can determine the merits of their application for a preliminary injunction.

2. In the alternative, the Plaintiffs ask the Court to issue a temporary restraining order enjoining the Defendants from treating firearms that have been considered legal “others” under Connecticut law as “assault weapons” until the Court can determine the merits of their application for a preliminary injunction.

3. A preliminary injunction barring the Defendants from enforcing Conn. Gen. Stat. §§ 53-202a, 53-202b, and 53-202c until such time as the Court makes a final determination on the merits in this matter.

Finally, the Plaintiffs hereby notify the Court and the Defendants that they are seeking *ex parte* and immediate relief.



Dated: February 3, 2023

Respectfully submitted,

    //s// Doug Dubitsky  
Doug Dubitsky, Esq.  
(ct21558)  
LAW OFFICES OF DOUG DUBITSKY  
P.O. Box 70  
North Windham, CT 06256  
Telephone: 860.933.9495  
Facsimile: 866.477.1120  
Email: [doug@lawyer.com](mailto:doug@lawyer.com)

    //s// Craig C. Fishbein  
Craig C. Fishbein, Esq.  
(ct25142)  
FISHBEIN LAW FIRM, LLC  
100 South Main Street  
P.O. Box 363  
Wallingford, Connecticut 06492  
Telephone: 203.265.2895  
Facsimile: 203.294.1396  
E-mail: [ccf@fishbeinlaw.com](mailto:ccf@fishbeinlaw.com)

    //s// Cameron L. Atkinson  
Cameron L. Atkinson, Esq.  
(ct31219)  
ATKINSON LAW, LLC  
122 Litchfield Rd., Ste. 2  
P.O. Box 340  
Harwinton, CT 06791  
Telephone: 203.677.0782  
Facsimile: 203.672.6551  
Email: [catkinson@atkinsonlawfirm.com](mailto:catkinson@atkinsonlawfirm.com)

*Attorneys for the Plaintiff*

**CERTIFICATION OF SERVICE**

The undersigned hereby certifies that, on the foregoing date, a copy of the foregoing was filed electronically and served by mail on anyone unable to accept electronic filing. Notice of this filing will be sent by email to all parties and counsel of record who have appeared by operation of the Court's electronic filing system or by mail to anyone unable to accept electronic filing. Parties may access this filing through the Court's system.

/s/ Cameron L. Atkinson /s/

UNITED STATES DISTRICT COURT  
DISTRICT OF CONNECTICUT

EDDIE GRANT, JR., JENNIFER HAMILTON;  
MICHAEL STIEFEL; CONNECTICUT  
CITIZENS DEFENSE LEAGUE, INC.; AND  
SECOND AMENDMENT FOUNDATION, INC.,

Plaintiffs,

v.

EDWARD M. LAMONT, JR., in his official capacity;  
JAMES ROVELLA, in his official capacity; PATRICK  
GRIFFIN, in his official capacity; MARGARET E.  
KELLY, in her official capacity; DAVID R.  
APPLEGATE, in his official capacity; JOSEPH T.  
CORRADINO, in his official capacity;  
SHARMESE L. WALCOTT, in her official capacity;  
DAVID R. SHANNON, in his official capacity;  
MICHAEL A. GAILOR, in his official capacity;  
CHRISTIAN WATSON, in his official capacity;  
JOHN P. DOYLE, JR., in his official capacity, PAUL  
J. NARDUCCI, in his official capacity; PAUL J.  
FERENCEK, in his official capacity; MATTHEW C.  
GEDANSKY, in his official capacity, MAUREEN  
PLATT, in her official capacity; ANNE F.  
MAHONEY, in her official capacity,

Defendants.

CIV. NO. 3:22-cv-01223-JBA

FEBRUARY 3, 2023

**MEMORANDUM OF LAW  
IN SUPPORT OF**

**PLAINTIFFS' EMERGENCY  
MOTION FOR A  
TEMPORARY  
RESTRAINING ORDER  
AND A PRELIMINARY  
INJUNCTION**

The Plaintiffs respectfully submit this Memorandum of Law in support of their Emergency Motion for a Temporary Restraining Order and a Preliminary Injunction.

The Plaintiffs filed this action on September 29, 2022 seeking a declaratory judgment that Connecticut's "assault weapon" ban is unconstitutional and seeking a permanent injunction against enforcement of that ban. On Tuesday, January 31, 2023, the United States Justice Department, through the Bureau of Alcohol, Tobacco, Firearms, and Explosives

**ORAL ARGUMENT REQUESTED**

(“ATF”), published a new rule in the Federal Register, effective immediately, redesignating a class of firearms known as “any other firearm” or simply “others” as either “rifles” or “short barreled rifles” depending on the barrel length. For most people in the United States who own “other” firearms with short barrels, the new ATF rule requires that they register the firearms with the ATF or replace the short barrel with a longer one. Those with “others” with barrels of sixteen inches or greater, need not do anything in response to the rule.

However, redesignating “others” as any type of rifle pushes them within the definition of “assault weapon” banned in Connecticut. “Others” were legal in Connecticut and did not fall under the “assault weapon” ban because they were neither “rifles,” “shotguns,” nor “pistols” – each of which (in the relevant configuration) falls within the definition of “assault weapon.” Until January 31, 2023, Connecticut residents, including the Plaintiffs, lawfully owned and peaceably used tens of thousands of “others.” Like all legal firearms purchased in Connecticut, each “other” was purchased with the express approval of the Connecticut Department of Emergency Services and Public Protection’s (“DESPP”) Special Licensing and Firearms Unit (“SLFU”). As of January 31, 2023, those tens of thousands of previously legal firearms are “assault weapons” – the simple possession of which is now a felony.

Each of the individual Plaintiffs and many members of both representative Plaintiffs currently own “others.” The Plaintiffs did not address “others” in the Complaint or Amended Complaint because, until January 31, 2023, “others” were not within the definition of “assault weapon” and were not banned under Connecticut law. Thus, until January 31, 2023, “others” were not within the scope of this litigation. “Others,” however, have now been redesignated by the new ATF rule to bring them within the definition of “assault weapon” under the statutory

scheme challenged in this action. Now, the Plaintiffs are at immediate risk of being arrested and prosecuted for possessing illegal “assault weapons” under the very laws that they have asked the Court to declare unconstitutional. This change in the law has now forced the Plaintiffs to seek emergency relief from the Court to protect them and others like them from arrest and prosecution under those laws.

Given the immediacy and severity of the danger, the Plaintiffs seek an emergency, *ex parte*, Temporary Restraining Order ordering the Defendants and their subordinates to refrain from enforcing Connecticut’s “assault weapon” ban in regard to any firearm previously designated as an “other,” and a Preliminary Injunction, upon an expedited opportunity for Defendants to be heard, enjoining the Defendants and their subordinates from enforcing Connecticut’s “assault weapon” ban.

### **FACTUAL BACKGROUND**

#### **I. Connecticut’s Criminalization of “Assault Weapons”**

Prior to 1993, Connecticut did not prohibit the purchase, sale, or possession of certain modern sporting rifles that it now classifies as “assault weapons.” In 1993, it changed course, enacting legislation that banned “assault weapons” and criminalized their possession. 1993 Conn. Pub. Acts 93-306, § 1(a); *see also New York State Rifle and Pistol Ass’n v. Cuomo*, 804 F.3d 242, 248 (2d Cir. 2015) (discussing the history of Connecticut’s assault weapons ban). The 1993 ban employed a two-track approach – banning 67 specifically named semiautomatic firearm models and firearms “capable of fully automatic, semiautomatic or burst fire at the option of the user.” *Cuomo*, 804 F.3d at 248.

A year after Pub. Acts 93-306, the United States Congress enacted the Violent Crime Control and Law Enforcement Act of 1994, which purported to restrict the manufacture, transfer, and possession of certain “semiautomatic assault weapons.” *Id.* The federal ban followed Connecticut’s two-track approach to a limited extent, banning 18 specific firearms but introducing what became known as the “two-feature test.” *Id.* The “two-feature test” banned “any semiautomatic firearm that contained at least two listed military-style features, including a telescoping stock, a conspicuously protruding pistol grip, a bayonet mount, a flash suppressor, and a grenade launcher.” *Id.* The federal ban, however, contained a sunset clause that caused it to expire in 2004. *Id.*

The approaching expiration of the federal “assault weapons” ban inspired Connecticut to adopt its own equivalent of the federal ban in 2001, embracing the “two feature test” for the first time. 2001 Conn. Pub. Acts 01–130, § 1. In 2013, Connecticut expanded its criminalization of “assault weapons” broadly to create the statutory schem that the Plaintiffs now challenge - Conn. Gen. Stat. §§ 53-202a-f and Conn. Gen. Stat. §§ 53-202h-j.<sup>1</sup>

The law makes the possession of an “assault weapon” a Class D felony and prescribes a punishment of a mandatory one-year sentence of incarceration and a maximum of five years’ incarceration. Conn. Gen. Stat. § 53-202c(a); *see also* Conn. Gen. Stat. § 53a-35a(8). It also makes the distribution, transportation, importation, stocking for sale, advertisement for sale, sale, or gifting of an “assault weapon” a Class C felony, which carries a mandatory two-year

---

<sup>1</sup> Conn. Gen. Stat. § 53-202g relates to reporting the loss or theft of a firearm and is not being challenged in this action.

sentence of incarceration and a maximum term of ten years' incarceration. Conn. Gen. Stat. § 53-202b(a)(1); *see also* Conn. Gen. Stat. § 53a-35a(7).

There is a limited “grandfathering” provision to the law, which allows individuals who lawfully possessed “assault weapons” on or prior to April 3, 2013 to continue to possess them if they proved previous lawful ownership to the Connecticut State Police, applied to the Connecticut State Police for a certificate of possession of the “assault weapons” by January 1, 2014, and have actually received the certificate. Conn. Gen. Stat. § 53-202d(a)(2). The “grandfathered” possession, however, is limited to narrowly defined places and for narrowly defined purposes, which do not include self-defense outside of a home. Conn. Gen. Stat. § 53-202d(f).

Connecticut’s two-track approach to defining “assault weapons” for purposes of criminalizing their possession, sale, and transfer first criminalizes the possession, sale, or transfer of approximately 160 specifically named firearm models in four statutory subsections. *See generally* Conn. Gen. Stat. § 53-202a. Second, it criminalizes the possession, sale, and transfer of all firearms that have certain features, which are classified in eleven categories. Conn. Gen. Stat. § 53-202a; *see* Dkt. No. 13 – Amended Complaint.

Thus, the statutory scheme criminalizes countless ubiquitous semiautomatic firearms that are widely popular and commonly used for lawful purposes in Connecticut and throughout the United States. Additionally, a violation of the ban on “assault weapons” saddles the average citizen with a felony conviction, rendering him/her ineligible to ever lawfully possess a firearm again in his/her life. *See e.g.*, 18 U.S.C. § 922(g)(1).

## II. Connecticut’s “Others”

Connecticut supervises the commercial sale of firearms through the SLFU. Since 2013, the SLFU has routinely approved the commercial sale of “others.” A firearm is considered an “other” because it does not meet the statutory definition of either “rifle,” “shotgun,” or “pistol” under Connecticut law. See Conn Gen Stat. Sec. 53a-3(16)-(18).

Despite being legal in Connecticut, “others” have drawn political ire because of their visual similarities to “assault rifles.” The key distinction, however, is that “others” often use “pistol braces”<sup>2</sup> which gives them a similar visual appearance to “assault rifles.” “Others,” however, have not previously been categorized as “rifles” or “assault weapons” under Connecticut or federal law as shown by SLFU’s systematic approval of their sale in Connecticut over the past decade.

On January 26, 2023, Defendant Lamont issued a press release indicating his intent to criminalize the possession of “others” in Connecticut. *See Exhibit A – Governor Lamont Announces 2023 Legislative Proposal, p. 2.*<sup>3</sup>

## III. The Department of Justice’s “Pistol Brace” Rule

After Congress defined what a “rifle” is in 18 U.S.C. § 921(a)(7), the Department of Justice included its statutory definition as a matter of course in 27 C.F.R. 479.11. On January 31, 2023, it amended 27 C.F.R. 479.11’s definition of a “rifle” by publishing a final rule in the

---

<sup>2</sup> “Pistol braces” are firearm accessories usually attach to a person’s forearm to provide greater stability. While their appearances resemble shoulder stocks, they are not intended to act as shoulder stocks.

<sup>3</sup> Retrieved from: <https://portal.ct.gov/Office-of-the-Governor/News/Press-Releases/2023/01-2023/Governor-Lamont-Announces-2023-Legislative-Proposal-on-Mass-Shootings#:~:text=So%2Dcalled%20%E2%80%9Cother%E2%80%9D%20weapons,do%20not%20include%20all%20weapons.>



Federal Register. *See* **Exhibit H - Factoring Criteria for Firearms With Attached “Stabilizing Braces.”** This new final rule changes the definition of “rifle” to include “a weapon that is equipped with an accessory component, or other rearward attachment (*e.g.*, a ‘stabilizing brace’) that provides surface area that allows the weapon to be fired from the shoulder....” *Id.* at p. 92. In particular, the final rule specifically factors “whether the surface area that allows the weapon to be fired from the shoulder is created by a buffer tube, receiver extension, or other rearward attachment that is necessary for the cycle of operations ... .” *Id.*

The operative effect of this final rule is to immediately classify most Connecticut “others” as either “rifles” or “short-barreled rifles,” which, in turn, renders them illegal under Connecticut’s “assault weapons” ban. While in most other states, a person in possession of an “other” with a stabilizing brace would be legally entitled to retain the firearm as a “rifle” or, by registering it with ATF as a “short barreled rifle,” in Connecticut, both designations bring the “other” into the category of banned “assault weapon.”

In an online public information session the ATF gave on January 31, 2023, the Department of Justice confirmed that continued possession of “others” is likely in violation of Connecticut state law. During that information session, members of the public directly asked the ATF officials if they could follow the same steps as people from other states to register their “others” as “short barreled rifles” under the final rule so they can keep them. **Exhibit C – Affidavit of Holly Sullivan, ¶ 12.** ATF officials responded that ATF would not be accepting registrations from Connecticut residents because the ATF takes the position that their “others” are now illegal “assault weapons” under Connecticut law. *Id.* at ¶ 14. Connecticut officials have yet to weigh in. *Id.* at ¶ 14.

#### IV. Plaintiff Eddie W. Grant, Jr.

Plaintiff Eddie Grant, Jr. is a retired Connecticut Department of Corrections officer who maintains his permanent residence in Meriden, Connecticut. **Exhibit D – Affidavit of Eddie W. Grant, Jr.**, ¶ 3. He has held a Connecticut pistol permit for over 30 years, and he meets all of the legal qualifications under federal and state law to acquire and possess firearms, ammunition, and magazines. *Id.* at ¶ 5. He is also a member and supporter of both the Connecticut Citizens Defense League, Inc. (“CCDL”) and the Second Amendment Foundation, Inc. (“SAF”). *Id.* at ¶ 6.

Grant served as a uniformed Corrections officer for twenty-one years, retiring in 2011. *Id.* at ¶ 7. During his service, the Department of Corrections assigned him to facilities such as Cheshire Correctional Institution (a Level 4 facility); Manson Youth Institution (a Level 4 facility); Carl Robinson Correctional Institution (a Level 3 facility); and Webster Correctional Institution (a Level 2 facility).<sup>4</sup> *Id.* at ¶ 7. Grant’s responsibilities included conducting armed transports of high-risk inmates and acting as an armed Perimeter Officer. *Id.* at ¶ 8. These responsibilities required the State of Connecticut to train Grant on the safe and effective use of AR-15-platform firearms, which are currently banned by the statutes at issue in this lawsuit. *Id.* at ¶ 8. After receiving his training, the State of Connecticut required Grant to qualify annually as a safe and effective user of AR-15-platform firearms. *Id.* at ¶ 8. Grant repeatedly

---

<sup>4</sup> A facility’s level designates what its security level is. Connecticut uses a five-level scheme with Level 1 being reserved for community release programs, Level 2 – minimum security, Level 3 – medium security, Level 4 – high security, and Level 5 – maximum security. *See* Conn. Gen. Assembly – Legislative Program Review and Investigations Committee, *Report: Factors Impacting Prison Overcrowding*, p. 16 (Dec. 2000). Retrieved from: [https://www.cga.ct.gov/pri/archives/fipo/20001201FINAL\\_Full.pdf](https://www.cga.ct.gov/pri/archives/fipo/20001201FINAL_Full.pdf)

qualified as a safe and effective user during his service with the Department of Corrections, and he carried and used AR-15-platform firearms during his service as a corrections officer. *Id.* at ¶ 8.

Grant seeks to lawfully purchase and possess an AR-15-platform firearm for defensive purposes. *Id.* at ¶ 9. Conn. Gen. Stat. §§ 53-202a and § 53-202c, however, prohibit him from purchasing or possessing an AR-15-platform firearm.

Grant's interest in lawfully purchasing and possessing an AR-15-platform firearm is no armchair interest. As an African-American, Grant is acutely conscious of the struggle that his parents, specifically his mother, faced growing up in 1950s-60s. *Id.* at ¶ 10. During the struggle for equality and civil rights in the Deep South, Grant's mother witnessed church burnings, and the racially motivated killings experienced by her family and friends were a concrete part of her life. *Id.* at ¶ 10. Grant's understanding that these racially motivated attacks were repelled in large part by the private ownership of effective defensive firearms as African-Americans bravely defended their lives and their right to equality under the rights guaranteed by the Constitution. *Id.* at ¶ 10.

In Grant's view, Conn. Gen. Stat. § 53-202a-c gives criminals and attackers a strong tactical advantage over him. *Id.* at ¶ 10. Criminals do not follow gun restrictions, placing him at a disadvantage to someone who possesses and carries any type of so-called "assault weapon" for malevolent purposes. As a law-abiding citizen, Grant wants, and intends, to lawfully purchase, possess, and defensively carry one or more of the firearms banned by Conn. Gen. Stat. §§ 53-202a and 53-202c. *Id.* at ¶ 12.

Grant also owns firearms that are Connecticut “others.” *Id.* at ¶ 15. He wishes to keep these firearms that he lawfully purchased and possessed. *Id.* at ¶ 18.

**V. Plaintiff Jennifer Hamilton**

Plaintiff Jennifer Hamilton is a Nuisance Wildlife Control Operator trained and licensed by the Connecticut Department of Energy and Environmental Protection and a firearms instructor who teaches initial pistol permit classes, personal defense classes, and tactical firearms use classes. **Exhibit E – Affidavit of Jennifer Hamilton**, ¶ 8. She maintains her permanent residence in Enfield, Connecticut, and she holds pistol permits from Connecticut and Massachusetts. *Id.* at ¶¶ 3, 5. She meets all federal and state requirements to lawfully acquire and possess firearms, ammunition, and magazines. *Id.* at ¶ 5. She is also a member and supporter of CCDL and SAF. *Id.* at ¶ 6.

Hamilton is a petite, 5’-2” tall woman who relies on defensive firearms instead of bodily strength to protect herself and her family from threats and attack. *Id.* at ¶ 7. Because of her physical size, Hamilton prefers firearms that are smaller and more customizable to her physical build. *Id.* at ¶¶ 9-10. Thus, she seeks, and intends, to lawfully purchase one or more firearms prohibited in Conn. Gen. Stat. § 53-202a – likely an AR-15-platform firearm – because of their adaptability and effectiveness for defensive purposes. *Id.* at ¶ 12. Additionally, Hamilton seeks to purchase such a firearm with a telescopic stock in order to adjust the firearm’s length of pull to fit her specific body type and size, which will, in turn, give her greater control over the firearm and improve her accuracy with it. *Id.* at ¶ 10.

Hamilton’s interest in purchasing, possessing, and carrying an AR-15-platform firearm is not abstract. She has been the victim of domestic violence, and she depends on effective defensive firearms to protect herself and her family from further attacks. *Id.* at ¶ 7.

Conn. Gen. Stat. §§ 53-202a and 53-202c prohibit her from purchasing either an AR-15-platform firearm or a similar rifle with a telescopic stock because they classify both as being “assault weapons.” In sum, Connecticut’s “assault weapon” ban prohibits Hamilton from purchasing, possessing, or carrying a firearm that she can operate more safely, comfortably, and effectively.

Hamilton also owns firearms that are Connecticut “others.” *Id.* at ¶ 15. She wishes to keep these firearms that she lawfully purchased and possessed. *Id.* at ¶ 18.

## **VI. Plaintiff Michael Stiefel**

Plaintiff Michael Stiefel is a retired Connecticut Department of Corrections officer. **Exhibit F – Affidavit of Michael Stiefel**, ¶ 10. He has held a Connecticut pistol permit for over thirty years, and he meets all of the state and federal requirements to lawfully acquire, possess, and bear firearms, ammunition, and magazines. *Id.* at ¶ 5. Stiefel is a member and supporter of CCDL and SAF.

Stiefel served as a uniformed Department of Corrections Officer for approximately 20 years, retiring in 2010. *Id.* at ¶ 7. During his career with the Department of Corrections, he was responsible for conducting armed transports of high-risk inmates and served as an armed perimeter officer. *Id.* at ¶ 7. Like Plaintiff Grant, these responsibilities required the State of Connecticut to train Stiefel on the safe and effective use of AR-15-platform firearms, which are currently banned by the statutes at issue in this lawsuit. *Id.* at ¶ 8. After receiving his

training, the State of Connecticut required Stiefel to qualify annually as a safe and effective user of AR-15-platform firearms. *Id.* at ¶ 8.

Stiefel seeks, and intends, to lawfully purchase and possess an AR-15-platform firearm for defensive purposes. *Id.* at ¶ 12. Connecticut’s “assault weapons” ban, however, prohibits him from purchasing or possessing an AR-15-platform firearm. Stiefel also currently owns firearms that have been previously classified as “others” in Connecticut. *Id.* at ¶ 15. He wishes to keep those firearms that he lawfully purchased and possesses. *Id.* at ¶ 18.

### **LEGAL STANDARD**

“The purpose of a temporary restraining order is to preserve an existing situation in status quo until the court has an opportunity to pass upon the merits of the demand for a preliminary injunction.” *Garcia v. Yonkers Sch. Dist.*, 561 F.3d 97, 107 (2d Cir. 2009). To obtain a temporary restraining order, “a party must demonstrate: (1) irreparable harm and (2) either (a) a likelihood of success on the merits or (b) a sufficiently serious question going to the merits and a balance of hardships tipping decidedly in the moving party's favor.” *Id.* Additionally, the moving party must show “that the public interest would not be disserved by the issuance of [the] injunction.” *Salinger v. Colting*, 607 F.3d 68, 79-80 (2d Cir. 2010) (internal quotation marks omitted). A temporary restraining order is an “extraordinary and drastic remedy, one that should not be granted unless the movant, by a clear showing, carries the burden of persuasion.” *Merrill Lynch, Pierce, Fenner & Smith, Inc. v. Reidy*, 447 F. Supp. 2d 472, 474 (D. Conn. 2007) (quoting *Moore v. Consol. Edison Co. of N.Y., Inc.*, 409 F.3d 506, 510 (2d Cir. 2005)) (internal quotation marks and citations omitted) (Arterton, J.).

The same substantive factors that govern the determination of a request for a temporary restraining order are virtually the same as those used to determine the merits of a motion for a preliminary injunction. *Local 1814, Int'l Longshoremen's Ass'n, AFL-CIO v. New York Shipping Ass'n, Inc.*, 965 F.2d 1224, 1228 (2d Cir. 1992).

To show irreparable harm, the Plaintiffs must show that, absent a preliminary injunction, they will “suffer an injury that is neither remote nor speculative, but actual and imminent, and one that cannot be remedied if a court waits until the end of trial to resolve the harm.” *Faiveley Transp. Malmö AB v. Wabtec Corp.*, 559 F.3d 110, 118 (2d Cir. 2009). “Whether there is an adequate remedy at law, such as an award of money damages, injunctions are unavailable except in extraordinary circumstances.” *Id.* at 118-19. Courts, however, will presume that a movant has established irreparable harm when the movant’s claim involves the alleged deprivation of a constitutional right. *Am. Civil Liberties Union v. Clapper*, 804 F.3d 617, 622 (2d Cir. 2015).

## **ARGUMENT**

### **I. Second Circuit Precedent Entitles the Plaintiffs to a Presumption of Irreparable Harm. In the Alternative, the Plaintiffs Satisfy the Test for Irreparable Harm.**

There is no question that the Plaintiffs are entitled to the presumption of irreparable harm. They claim a constitutional right to keep and bear modern sporting arms and “others” for the purposes of self-defense and allege that the challenged statutory scheme banning “assault weapons,” and the new ATF rule bringing “others” within that scheme, puts the Defendants at imminent risk of being deemed felons for no fault of their own.

The Supreme Court has twice established that the Second Amendment’s text protects the right to keep and bear arms in case of confrontation. *New York State Rifle & Pistol*

*Association, Inc. v. Bruen*, 142 S.Ct. 2111, 2127 (Jun. 23, 2022); *District of Columbia v. Heller*, 554 U.S. 570, 592 (2008). *Bruen* solidifies *Heller*'s holding that the Second Amendment's protections are not limited "only to those arms in existence in the 18<sup>th</sup> century." *Bruen*, 142 S.Ct. at 2132 (quoting *Heller*, 554 U.S. at 582) (internal quotation marks and alterations omitted). Instead, "the Second Amendment extends, *prima facie*, to all instruments that constitute bearable arms, even those that were not in existence at the time of the founding." *Id.* at 2132 (quoting *Heller*, 554 U.S. at 582) (internal quotation marks omitted); see also *Caetano v. Massachusetts*, 577 U.S. 411 (2016) (holding that the Second Amendment, *prima facie*, protects stun guns). Thus, the Second Amendment presumptively protects the Plaintiffs' right to possess and bear modern sporting arms – including AR-15 platform firearms – and Connecticut "others" unless the Defendants "affirmatively prove that [their] firearms regulation is part of the historical tradition that delimits the outer bounds of the right to keep and bear arms." *Bruen*, 142 S.Ct. at 2127.

The Defendants have never before carried their burden under the historical analysis mandated by *Bruen*, and they cannot do so now. Their enforcement of Connecticut's criminalization of the possession, carrying, and sale of modern sporting firearms deprives the Plaintiffs of their constitutional right to keep and bear "bearable arms." *Bruen* at 2132. Thus, the Plaintiffs are entitled to a presumption of irreparable harm based on their alleged deprivation of their constitutional rights. *Clapper*, 804 F.3d at 622.

The Plaintiffs clearly meet the standard for preliminary relief notwithstanding the presumption of irreparable harm. The Plaintiffs seek to obtain, possess, and bear modern sporting firearms for the purpose of self-defense. Every day that passes that they cannot do



so without facing criminal consequences is an injury that money cannot remedy. In fact, the Plaintiffs seek no monetary remedy, nor is such a remedy likely available to them. Declaratory and injunctive relief is their only available remedy. They should not be required to wait for it, especially in a case where the Defendants bear the burden of proving the constitutionality of their conduct, a burden the Defendants simply cannot meet.

Finally, the Plaintiffs also stand at imminent risk of irreparable harm due to the convoluted interaction between the challenged Connecticut statutory scheme and the ATF's new interpretation of federal law. ATF's new rule converted the Plaintiffs' lawfully- possessed Connecticut "others" into "rifles" or "short-barreled rifles" – each of which is banned in Connecticut under the challenged statutory scheme – and immediately and without warning, seismically shifted the status quo. This instantaneous conversion renders the Plaintiffs at risk of arrest, prosecution, and incarceration for possessing firearms that the Defendants previously indicated were perfectly legal in Connecticut. No relief could adequately remedy the harm that such unwarranted arrests and criminal prosecutions would impose on the Plaintiffs. The Plaintiffs need an immediate order restraining the Defendants from enforcing the "assault weapon" ban against them.

Not only does this drastic regulatory change pose a concrete and imminent risk of harm to the Plaintiffs, but it also upends the legal status quo under which the parties have been operating for the past ten years. Thus, there is good cause for the Court to find an emergency need to issue a temporary restraining order on an *ex parte* basis to preserve that status quo until the parties can be heard on the merits of a preliminary injunction.

## II. The Plaintiffs Show a Likelihood of Success on the Merits, and Raise Serious Questions Going to the Merits Sufficient to Make a Fair Ground for Litigation.

Under the Supreme Court’s newly clarified standard for reviewing claims of Second Amendment violations, the Plaintiffs easily surpass the threshold of showing a likelihood of success on the merits. On June 23, 2022, the U.S. Supreme Court drastically reshaped Second Amendment jurisprudence in *New York State Rifle & Pistol Association, Inc. v. Bruen*, 142 S.Ct. 2111 (Jun. 23, 2022). *Bruen* abrogated the use of tiers of “means-end” scrutiny – e.g., rational basis, intermediate, and strict scrutiny – that American courts have habitually used to assess Second Amendment rights claims and replaced it with a textual and historical analysis. The reshaped analysis negates the use of the “means-end” scrutiny *New York State Rifle and Pistol Ass’n, Inc. v. Cuomo*, 804 F.3d 242 (2d Cir. 2015) and *Shew v. Malloy*, 994 F.Supp.2d 234 (D.Conn. 2014) used to uphold Connecticut’s criminalization of “assault weapons,” and it requires a fresh consideration of their ultimate conclusions under *Bruen*’s textual and historical analysis.<sup>5</sup>

While the Plaintiffs retain the initial burden to show either “likelihood of success on the merits” or “sufficiently serious questions going to the merits to make them a fair ground for litigation” at this stage, *Bruen*’s textual and historical analysis shifts the burden to the Defendants to defend their criminalization of “assault weapons” and their infringement on the Plaintiffs’ constitutional rights. Under the Supreme Court’s new analytical framework, the Defendants are unable to satisfy that burden.

---

<sup>5</sup> The Supreme Court itself has summarily instructed lower courts to reconsider decisions upholding “assault weapons” bans in the wake of *Bruen*. See *Bianchi v. Frosh*, 142 S.Ct. 2898 (Mem) (Jun. 30, 2022) (reversing and remanding a Fourth Circuit decision upholding Maryland’s “assault weapons” ban).

**A. *Bruen* replaces the Second Circuit’s “two step” test with a textual and historical analysis under which the Defendants bear a heavy burden of proof.**

*Bruen* changed everything. Prior to *Bruen*, the Second Circuit used a “two-step” test.<sup>6</sup> *Cuomo*, 804 F.3d at 254. It first considered whether the challenged law “burdens conduct protected by the Second Amendment.” *Id.* If the law did not implicate conduct that the Second Amendment protects, the law survived. *Id.* If, however, the law burdened conduct protected by the Second Amendment, courts then assessed the appropriate level of scrutiny to apply. *Id.*

At the first step of the test, courts examined whether the arms at issue are “in common use” and “typically possessed by law-abiding citizens for lawful purposes.” *Id.* at 254-55. In *Cuomo*, the Second Circuit ruled that “assault weapons” met both criterion *Id.* at 255-57.

Under the second step, pre-*Bruen* courts then assessed “how close the law comes to the core of the Second Amendment right” and “the severity of the law’s burden on the right.” *Id.* at 258. In *Cuomo*, the Second Circuit applied intermediate scrutiny and found that while New York and Connecticut’s “assault weapons” bans did indeed burden the core of the Second Amendment’s protections, alternatives to such firearms – namely handguns – remained available for home defense. *Id.* at 258-261. Thus, the Second Circuit found the burden on the Plaintiffs’ core of the Second Amendment right insufficiently severe to strike down New York and Connecticut’s “assault weapons” bans. *Id.* at 261.

---

<sup>6</sup> As noted by the Second Circuit, it was not alone in applying the “two step” test. *Cuomo*, 804 F.3d at 254 (noting that the Third, Fourth, Fifth, Six, Seventh, Ninth, Tenth, Eleventh, and D.C. Circuits also used the same general approach).

*Bruen* explicitly rejects the “two step” test and “means-end” scrutiny previously used in the Second Circuit as being inconsistent with *District of Columbia v. Heller*, 554 U.S. 570 (2008) and *McDonald v. City of Chicago*, 561 U.S. 742 (2010):

Despite the popularity of this two-step approach, it is one step too many. Step one of the predominant framework is broadly consistent with *Heller*, which demands a test rooted in the Second Amendment's text, as informed by history. But *Heller* and *McDonald* do not support applying means-end scrutiny in the Second Amendment context.

*Bruen*, 142 S.Ct. at 2127. Instead, *Bruen* holds that “the government must affirmatively prove that its firearms regulation is part of the historical tradition that delimits the outer bounds of the right to keep and bear arms.” *Id.* This, the Defendants cannot do.

*Bruen*'s analysis starts with the Second Amendment's text:<sup>7</sup> “[W]hen the Second Amendment's plain text covers an individual's conduct, the Constitution presumptively protects that conduct.” *Id.* at 2126. The Supreme Court explained: “*Heller*'s methodology centered on constitutional text and history. Whether it came to defining the character of the right (individual or militia dependent), suggesting the outer limits of the right, or assessing the constitutionality of a particular regulation, *Heller* relied on text and history. It did not invoke any means-end test such as strict or intermediate scrutiny.” *Id.* at 2128-29. As *Bruen* indicates, the Second Amendment's text and history left “no doubt” that the “Second Amendment confers an individual right to keep and bear arms.” *Id.* at 2127 (quoting *Heller*, 554 U.S. at 595) (internal quotation marks omitted).

---

<sup>7</sup> “A well regulated Militia, being necessary to the security of a free State, the right of the people to keep and bear Arms, shall not be infringed.” U.S. Const. Amend. II.

*Bruen* confirmed *Heller*'s finding that it is "fairly supported by the historical tradition of prohibiting the carrying of dangerous and unusual weapons that the Second Amendment protects the possession and use of weapons that are in common use at the time." *Id.* at 2128 (quoting *Heller*, 554 U.S. at 627) (internal quotation marks omitted).

In the context of this action, *Bruen*'s test is straightforward. First, the Court must determine whether the right claimed by the Plaintiffs falls within the protections of the Second Amendment's text. Second, the Court must consider the "dangerous and unusual weapons" exception within the historical guidelines established by *Heller* and *Bruen*.

There is absolutely no question that the Plaintiffs meet the first requirement. They claim a right to keep and bear modern sporting firearms for the purposes of self-defense. Both *Heller* and *Bruen* establish that the Second Amendment's text protects the individual right to keep and bear arms in case of confrontation. *Bruen*, 142 S.Ct. at 2127; *Heller*, 554 U.S. at 592. *Bruen* solidifies *Heller*'s holding that the Second Amendment's protections do not apply "only to those arms in existence in the 18<sup>th</sup> century." *Bruen*, 142 S.Ct. at 2132 (quoting *Heller*, 554 U.S. at 582) (internal quotation marks and alterations omitted). Instead, "the Second Amendment extends, *prima facie*, to all instruments that constitute bearable arms, even those that were not in existence at the time of the founding." *Id.* at 2132 (quoting *Heller*, 554 U.S. at 582) (internal quotation marks omitted); *see also Caetano v. Massachusetts*, 577 U.S. 411 (2016) (holding that the Second Amendment, *prima facie*, protects stun guns). In *Cuomo*, the Second Circuit determined that Connecticut's "assault weapons" ban did indeed burden the core of the Second Amendment's protections. *Cuomo* at 258-261. Thus, the Second Amendment presumptively protects the Plaintiffs' right to possess and bear modern sporting firearms --

including AR-15 platform firearms – and “others” unless the Defendants “affirmatively prove that [their] firearms regulation is part of the historical tradition that delimits the outer bounds of the right to keep and bear arms.” *Bruen*, 142 S.Ct. at 2127. Again, this is a burden the Defendants cannot meet.

The now-deceased “means-end” scrutiny test purported to give courts the power to “make difficult empirical judgements about the cost and benefits of firearms restrictions...” – judgments that they are ill-suited to make “especially given their lack of expertise in the field.” *Id.* at 2130 (quoting *City of Chicago v. McDonald*, 561 U.S. 742, 790-791 (2010)) (internal quotation marks and alterations markings omitted). *Bruen* now flatly forbids this type of interest balancing:

If the last decade of Second Amendment litigation has taught this Court anything, it is that federal courts tasked with making such difficult empirical judgments regarding firearm regulations under the banner of “intermediate scrutiny” often defer to the determinations of legislatures. But while that judicial deference to legislative interest balancing is understandable—and, elsewhere, appropriate—it is not deference that the Constitution demands here. The Second Amendment “is the very *product* of an interest balancing by the people” and it “surely elevates above all other interests the right of law-abiding, responsible citizens to use arms” for self-defense. *Heller*, 554 U.S. at 635, 128 S.Ct. 2783. It is this balance—struck by the traditions of the American people—that demands our unqualified deference.

*Id.* at 2131 (emphasis in original).

Instead, *Bruen* requires courts to assess “whether modern firearms regulations are consistent with the Second Amendment’s text and historical understanding” through “reasoning by analogy – a commonplace task for any lawyer or judge.” *Id.* at 2131, 2132. It contemplates two types of cases: straightforward cases, and “other cases implicating unprecedented societal concerns or dramatic technological changes.” *Id.* at 2131-32.

*Bruen* describes the straightforward cases as follows:

For instance, when a challenged regulation addresses a general societal problem that has persisted since the 18th century, the lack of a distinctly similar historical regulation addressing that problem is relevant evidence that the challenged regulation is inconsistent with the Second Amendment. Likewise, if earlier generations addressed the societal problem, but did so through materially different means, that also could be evidence that a modern regulation is unconstitutional. And if some jurisdictions actually attempted to enact analogous regulations during this timeframe, but those proposals were rejected on constitutional grounds, that rejection surely would provide some probative evidence of unconstitutionality.

*Id.* at 2131.

This case falls squarely within *Bruen*'s category of straightforward cases. Crimes perpetrated with firearms have existed since firearms were invented. But it was not until long after the Second Amendment was ratified that local governments began to ban whole categories of firearms from the people under the guise of crime prevention. The Founders knew well of the misuse of firearms by criminals, but their regulation to address that societal problem was not to ban bearable arms from the public as Connecticut has done. To the contrary, the Founders' regulatory response – the Second Amendment – was to guaranty that every law-abiding person in the nation had the unfringed right to keep and bear arms for their personal defense and the defense of others. There is no “distinctly similar historical regulation addressing that problem. . . .” *Id.* Thus, Connecticut's statutory scheme must fall.

But even viewing Connecticut's “assault weapon” ban under a more complex analysis, it has no “well-established and representative historical analogue” to save it. *Id.* at 2133. When a court considers the more complex “modern regulations that were unimaginable at the founding,” however, *Bruen* requires the Defendants to identify “a well-established and representative historical analogue...” to its modern regulations. *Id.* at 2133. To determine

whether the analogue is representative and “relevantly similar under the Second Amendment,” *Bruen* provides courts with “at least two metrics” that “are [the] *central* considerations when engaging in an analogical inquiry” from *Heller* and *McDonald*: “how and why the regulations burden a law-abiding citizen’s right to armed self-defense.” *Id.* at 2132-33 (internal quotation marks and citations omitted) (emphasis in original).

The *Bruen* analysis requires that the historical inquiry must focus on the scope of the people’s constitutional rights “they were understood to have *when the people adopted them.*” *Id.* at 2136 (internal quotation marks and citations omitted) (emphasis in original). The Supreme Court in *Bruen* cautioned courts to focus on common law practices that “prevailed up to the period immediately before and after the framing of the Constitution” and contemporary history in the immediate postenactment period. *Id.* at 2136-37 (internal quotation marks and citations omitted). In particular, *Bruen* cautions courts “against giving postenactment history more weight than it can rightly bear,” and it describes mid-to-late 19<sup>th</sup> century evidence as confirmation of the original public meaning instead of being of independent significance. *Id.* at 2136-37.

*Bruen* closes its instructions on these more complex cases with two cautions to courts. First, it expressly forbids courts from entertaining or engaging in “independent means-end scrutiny under the guise of an analogical inquiry.” *Id.* at 2133 n.7. Second, while *Bruen* does not require the Defendants to “identify... a historical *twin*” or “a dead ringer” as an historical analogue, it also does not permit courts to “uphold every modern law that remotely resembles a historical analogue... because doing so risks endorsing outliers that our ancestors would



never have accepted.” *Id.* at 2133 (internal quotation marks, citations, and alteration marks omitted) (emphasis in original).

Here, there were simply no common law practice that “prevailed up to the period immediately before and after the framing of the Constitution” and contemporary history in the immediate postenactment period which is a “well-established and representative historical analogue” to Connecticut’s ban on an entire category of bearable arms. *Id.* at 2136-37. Connecticut’s “assault weapon” ban is unconstitutional.

**B. The modern sporting firearms banned by the Defendants are not “dangerous and unusual.”**

Because the firearms banned by the challenged statutory scheme, and “others” which have unexpectedly been drawn into that scheme, are each in common use for lawful purposes – both in Connecticut and nationwide – they cannot be found to be “dangerous and unusual.” The “dangerous and unusual” exception to protection under the Second Amendment has its roots in *United States v. Miller*, 307 U.S. 174 (1939). *Miller* permitted the felony indictment of two men who transported a short-barreled shotgun across state lines without obtaining permission from, or registering it with, federal authorities. *Id.* at 175. The district court dismissed the indictment on the ground that the law violated the men’s Second Amendment rights, and the government appealed. *Id.* at 176-77. The Supreme Court reversed the dismissal of the indictment on the grounds that there was no evidence that short-barreled shotguns had a reasonable relationship to “the preservation or efficiency of a well-regulated militia.” *Id.* at 178. It reasoned that the Second Amendment protected the arms that were “of the kind in common use at the time” and which citizens would bring with them if called upon to serve in the militia. *Id.* at 179.

Since *Miller*, the Supreme Court has only once clarified the “dangerous and unusual” exception. See *Caetano v. Massachusetts*, 577 U.S. 411 (2016). In *Caetano*, the Court found “stun guns” were protected arms under the Second Amendment, and corrected two fatal errors that the Massachusetts Supreme Judicial Court made in labeling them as “dangerous and unusual” weapons. *Id.* The first was the Massachusetts court’s erroneous conclusion that the Second Amendment did not protect weapons that “were not in common use at the time of the Second Amendment’s enactment.” *Id.* at 411-12 (reaffirming *Heller*’s statement that the Second Amendment “extends... to... arms... that were not in existence at the time of the founding”) (internal quotation marks and citations omitted). The second was the Massachusetts court’s erroneous conclusion that the Second Amendment did not protect “stun guns” because “nothing in the record [suggested] that [they] are readily adaptable to use in the military.” *Id.* at 412 (reaffirming *Heller*’s rejection of that proposition) (internal quotation marks and citations omitted).

That a given class of firearms may be “dangerous” is irrelevant to a Second Amendment analysis if it is commonly used for lawful purposes. *Caetano* at 418, (“the relative dangerousness of a weapon is irrelevant when the weapon belongs to a class of arms commonly used for lawful purposes.”) (Alito, J. concurring). The most relevant statistic for finding electronic defense weapons are not “unusual” was that “hundreds of thousands of Tasers and stun guns have been sold to private citizens, who it appears may lawfully possess them in 45 States.” *Id.* at 420 (Alito, J. concurring) (internal quotation marks, citations, and alteration marks omitted).

The Second Circuit has not exempted any class of firearms from Second Amendment protection under *Bruen*'s "dangerous and unusual" analysis.<sup>8</sup> To the extent it addressed the issue in *Cuomo* concerning Connecticut's "assault weapons" ban, **the Second Circuit expressly held that**, even accepting most conservative statistical estimates presented by the parties and amici,<sup>9</sup> **"assault weapons" are in common use.** *New York State Rifle and Pistol Ass'n, Inc. v. Cuomo*, 804 F.3d 242, 255 (2d Cir. 2015). The Second Circuit relied on a conservative estimate that "assault weapons" constituted about two percent of the nation's firearms, or approximately seven million firearms. *Id.* at 255. On the basis of that estimate, **the Second Circuit held that "the assault weapons... at issue are 'in common use' as that term was used in *Heller*."** *Id.* at 255.

Despite the Supreme Court's revised standard set forth in *Bruen*, there is no question that the Second Circuit's holding that "assault weapons" are not "unusual" remains good law and is dispositive of this motion for a temporary restraining order and a preliminary injunction – and this entire case – since the Defendants bear the burden to prevail on both elements. A class of firearms cannot be "dangerous and unusual" if it is not unusual. Thus, as long as the Plaintiffs make a showing of common usage that at least approaches the two percent found in *Cuomo*, the Plaintiffs prevail on the merits.

---

<sup>8</sup> The Second Circuit did not fully engage with the "dangerous" element, which it classified as "typical possession." *Cuomo*, 804 F.3d at 256-57. Instead, it assumed *arguendo* that these "commonly used weapons and magazines are also typically possessed by law-abiding citizens for lawful purposes" – an approach used by the D.C. Circuit and the D.C. district court after the Supreme Court remanded *Heller*. *Id.* at 257.

<sup>9</sup> *Cuomo* was clear that the "unusual" element requires "an objective and largely statistical inquiry." *Id.* at 256.

In Connecticut and nationwide, both “assault weapons” and “others” are in common use for lawful purposes as defined by the Second Circuit. Any inquiry into whether modern sporting firearms are “unusual” begins with where they are legal. *Caetano*, 577 U.S. at 420 (2016) (Alito, J., concurring). Research reveals that only 9 states and the District of Columbia prohibit their possession.<sup>10</sup> The class of firearms subject to the challenged law are legal to freely buy, sell, and own in the remaining forty-one states. Thus, the overwhelming majority of the states recognize that modern sporting firearms are not “dangerous and unusual,” and the few states such as Connecticut that prohibit their possession are outliers.

The second aspect of the “unusual” inquiry objectively examines the statistical data supporting whether modern sporting firearms are in “common use.” *Cuomo*, 804 F.3d at 255-56. While there is no minimum threshold of common usage that the Plaintiffs need to show, they clearly surpass the “hundreds of thousands” finding that Justice Alito declared sufficient in his *Caetano* concurrence regarding stun guns. More importantly, they at least equal or surpass the threshold that the Second Circuit recognized as establishing “common usage.” *Cuomo*, 804 F.3d at 255 (relying on the most conservative estimates and still finding that “assault weapons” were in common use). The most conservative estimate as to the popularity of a single model of modern sporting arm – the AR-15 – was “two percent of the nation’s firearms” or

---

<sup>10</sup> California – see Cal. Penal Code §§ 16350, 16790, 16890, 30500-31115; Connecticut – laws already discussed; Delaware – see Del. Code tit. 11, § 1466(a); Hawaii – see Haw. Rev. Stat. Ann. §§ 134-1, 134-4, 134-8; Illinois – see IL HB 5471, enacted January 10, 2023; Maryland – see Md. Code Ann., Crim. Law §§ 4-301 – 4-306, Md. Code Ann., Pub. Safety § 5-101(r); Massachusetts – see Mass. Gen. Laws ch. 140, §§ 121, 122, 123, 131M; New Jersey – see N.J. Stat. Ann. §§ 2C:39-1w, 2C:39-5, 2C:58-5, 2C:58-12, 2C:58-13; New York – see N.Y. Penal Law §§ 265.00(22), 265.02(7), 265.10, 400.00(16-a); DC Code Ann. §§ 7-2501.01(3A), 7-2502.02(a)(6), 7-2505.01, 7-2505.02(a), (c)

“approximately seven million guns.” *Id.* at 255. Simply put, in the Second Circuit, two percent or more clearly equals common use.

Under an objective “unusual” inquiry, the Defendants’ own data dooms their case. In a January 17, 2023 response to a Freedom of Information Act request, the SLFU declared that there are 1,306,867 firearms in the state weapons registry database. **Exhibit B, Affidavit of Ray Bevis, Jr.** ¶¶ 13, 14. In a January 10, 2020 response to a Freedom of Information Act request, the SLFU declared that there are 53,849 “assault weapons” registered in Connecticut. *Id.* at ¶¶ 7, 15. 53,849 “assault weapons” is approximately 4.1% of the 1,306,867 firearms in the state weapons registry database, more than enough to show common use under Second Circuit precedent. *Id.* at ¶¶ 7, 15.

In its January 17, 2023 response, SLFU also declared that, of those 1,306,867 firearms, there are 88,766 firearms in the state weapons registry database that are classified as “others.” *Id.* at ¶¶ 13, 16. In other words, approximately 6.8 percent of Connecticut’s registered firearms are “others,” which, based on the ATF’s new rule, have suddenly become “assault weapons” under Connecticut’s ban. *Id.* at ¶¶ 13, 16. That is more than three times the percentage of firearms that *Cuomo* found to constitute “common use.”

The Defendants fair no better when it comes to national data. According to production and import/export data ranging from 1991-2018 compiled and estimated by the National Shooting Sports Foundation (“NSSF”) based on the ATF’s Annual Firearms Manufacturing and Export Report (“AFMER”), there are approximately 254,752,987 firearms in circulation in the United States. **Exhibit G – Declaration of Salam Fatohi**, ¶¶ 6-7, 12. Approximately 24,446,000 of those firearms are modern sporting rifles. *Id.* at ¶ 17. In other words, an

estimated 10 percent of all firearms currently in circulation in the United States are modern sporting rifles, a.k.a. “assault rifles.” *Id.* at pp. 2, 7. That is approximately five times the percentage of the same type of firearms that *Cuomo* found to constitute “common use.”

Thus, there is absolutely no question that the firearms banned by the challenged statutory scheme as “assault weapons” are in common use both in Connecticut and nationally, as are “others” which have now been redefined as such. Therefore, both are protected by the Second Amendment and neither can be considered “dangerous and unusual.”

### **III. The Balance of Hardships Decidedly Tips in Favor of the Plaintiffs.**

Law-abiding citizens yesterday, potential felons today. The Plaintiffs woke up on January 31, 2023 to that new reality when the Department of Justice published the final “Pistol Brace” rule in the Federal Register, and the ATF announced that it considered all Connecticut “others” to be illegal under Connecticut law. The Plaintiffs are not alone. The law-abiding owners of over 80,000 firearms in Connecticut find themselves in the same frightening position: wondering whether they will receive a knock on their door and cuffs on their wrists for merely possessing the common firearms that the Defendants have assured them were legal.

Their dilemma is no abstraction. Connecticut law has succumbed to the political passions led by Defendant Lamont’s near-daily anti-constitutional rhetoric in the press. Individuals who violate Connecticut’s prohibition on the ownership of “assault weapons” can expect little mercy or sympathy in Connecticut’s criminal justice system. The Plaintiffs, and tens of thousands of law-abiding Connecticut residents are at real and immediate risk of Defendants’ enforcement actions.

The federal government's view that Connecticut residents such as the Plaintiffs, who own "others," are now violating Connecticut's prohibition on the possession of "assault weapons," geometrically increases risk to Plaintiffs and other lawful firearm owners across the state. While Connecticut officials have yet to weigh in on the impact of the federal rule turning "others" into "rifles" or "short barreled rifles," Connecticut law's close adherence to federal definitions of the categories of firearms strongly suggests Connecticut officials taking quick action against the Plaintiffs and other lawful firearms owners in direct violation of the constitutional rights protected by the Second, Fifth, Fourteenth and other Amendments.

Any balancing of the equities does not require the Plaintiffs to sit idly by and wait until the Defendants declare them felons to seek relief to protect their constitutional rights. Nor does any balancing of equities justify withholding immediate and preliminary relief from the Plaintiffs.

More broadly speaking, *Cuomo* already made the necessary findings regarding the common use of "assault weapons." *Cuomo*, 804 F.3d at 255-56. *Bruen*'s elimination of the second part of *Cuomo*'s analysis – the part that upheld Connecticut's "assault weapons" ban under the now-abrogated "two-part test" – did not change *Cuomo*'s findings on the first part of the test. As soon as the Supreme Court issued its decision in *Bruen*, the findings in *Cuomo* rendered Connecticut's "assault weapons" ban unconstitutional.

While the Court must *presume* in this case that the Plaintiffs will suffer irreparable harm, *Clapper*, 804 F.3d at 622, the harm that they are suffering is *actually* irreparable, and the Court should consider that in any balancing of the hardships. Every day that passes where the Plaintiffs cannot purchase, keep, and bear modern sporting firearms places them at a

disadvantage to violent criminals who have no regard for the law and who may target them. Every day that leaves the Plaintiffs under a cloud of uncertainty, not knowing if the Defendants will send forces knocking to enforce the “assault weapon” ban based on the federal government’s new rule, is a day stripped from the Plaintiffs’ peaceful enjoyment of their constitutional rights. Every day that passes is a day the Plaintiffs’ ability to exercise their constitutional rights is lost forever. The Court should decline to leave them so vulnerable.

For these reasons, the Court should make two findings as to the question of balancing the hardships. First, it should find that the change in federal law has placed the Plaintiffs at the likely and extreme risk of being subject to the heavy burden of criminal prosecutions as felons under politically motivated Connecticut law with no prior notice and in violation of their Second Amendment rights. Second, the Court should find that the Plaintiffs are suffering irreparable harm through the ongoing deprivation of their constitutional rights and that, after the *Bruen* decision, *Cuomo* clearly establishes that Connecticut’s “assault weapons” ban is unconstitutional.

#### **IV. The Public Interest Will be Served by a Temporary Restraining Order and a Preliminary Injunction.**

The Second Amendment is not a “second class right” and the Supreme Court has made it abundantly clear that lower courts shall no longer treat it as such. *McDonald*, 561 U.S. at 780. Courts can no longer interest balance away the people’s Second Amendment rights. The Supreme Court stated in *Bruen* that “[t]he Second Amendment is the *very product* of an interest balancing by the people and it surely elevates above all other interests the right of law-abiding, responsible citizens to use arms for self-defense.” *Bruen*, 142 S.Ct. at 2131 (internal citations



and quotation marks omitted) (emphasis in original). Thus, it “demands” courts’ “unqualified deference” to the Plaintiffs’ Second Amendment rights. *Id.* at 2131.

The Defendants cannot shoehorn the commonly used firearms at issue in this action into the “dangerous and unusual” exception. The Second Circuit in *Cuomo* has already definitively settled that question. All that remains is for the Court to apply the *Bruen* standard and protect the Plaintiffs from ongoing, and imminent irreparable harm by issuing a temporary restraining order and a preliminary injunction.

Since the Plaintiffs have shown that the Defendants are highly unlikely to carry their burden in the face of *Bruen* and *Cuomo*, the Court’s issuance of emergency injunctive relief would preserve the status quo, and protect and uphold the public interest articulated in the Second Amendment. At the same time, it would not disturb other Connecticut laws that, for example, screen who may purchase or possess a firearm. Thus, the public interest favors emergency relief in this case.

### **CONCLUSION**

For all of the aforementioned reasons, the Plaintiffs respectfully ask the Court to issue, on an emergency basis, an *ex parte*, Temporary Restraining Order ordering the Defendants, and those under them, to refrain from enforcing Connecticut’s “assault weapon” ban in regard to any firearm previously designated as “any other firearm” or an “other,” and a Preliminary Injunction, upon notice to all parties and an expedited opportunity to be heard, enjoining the Defendants and those under them from enforcing Connecticut’s “assault weapon” ban pending full adjudication on the merits of the Plaintiffs’ claims.

Dated: February 3, 2023

Respectfully submitted,

    //s// Doug Dubitsky  
Doug Dubitsky, Esq.  
(ct21558)  
LAW OFFICES OF DOUG DUBITSKY  
P.O. Box 70  
North Windham, CT 06256  
Telephone: 860.933.9495  
Facsimile: 866.477.1120  
Email: [doug@lawyer.com](mailto:doug@lawyer.com)

    //s// Craig C. Fishbein  
Craig C. Fishbein, Esq.  
(ct25142)  
FISHBEIN LAW FIRM, LLC  
100 South Main Street  
P.O. Box 363  
Wallingford, Connecticut 06492  
Telephone: 203.265.2895  
Facsimile: 203.294.1396  
E-mail: [ccf@fishbeinlaw.com](mailto:ccf@fishbeinlaw.com)

    //s// Cameron L. Atkinson  
Cameron L. Atkinson, Esq.  
(ct31219)  
ATKINSON LAW, LLC  
122 Litchfield Rd., Ste. 2  
P.O. Box 340  
Harwinton, CT 06791  
Telephone: 203.677.0782  
Facsimile: 203.672.6551  
[Email: catkinson@atkinsonlawfirm.com](mailto:catkinson@atkinsonlawfirm.com)

*Attorneys for the Plaintiff*

**CERTIFICATION OF SERVICE**

The undersigned hereby certifies that, on the foregoing date, a copy of the foregoing was filed electronically and served by mail on anyone unable to accept electronic filing. Notice of this filing will be sent by email to all parties and counsel of record who have appeared by operation of the Court's electronic filing system or by mail to anyone unable to accept electronic filing. Parties may access this filing through the Court's system.

/s/ Cameron L. Atkinson /s/

# **Exhibit A**

[\(/Office-of-the-Governor\)](#)

# The Office of Governor Ned Lamont

[CT.gov Home](#) [\(/\)](#) [Governor Ned Lamont](#) [\(/Office-of-the-Governor\)](#) [News](#) [\(/Office-of-the-Governor/News\)](#) [Press Releases](#) [\(/Office-of-the-Governor/News/Press-Releases\)](#)

Governor Lamont Announces 2023 Legislative Proposal: Preventing Mass Shootings

## Press Releases



STATE OF CONNECTICUT

## GOVERNOR NED LAMONT

01/26/2023

### Governor Lamont Announces 2023 Legislative Proposal: Preventing Mass Shootings

Group of Gun Violence Prevention Proposals Are the Second Set the Governor Has Announced So Far This Session

#### Governor Lamont Announces 2023 Legislative Proposal: Preve



FEEDBACK +

(HARTFORD, CT) – Governor Ned Lamont today held a news conference in Hartford to announce the second of three sets of proposals he will introduce during the 2023 legislative session that are focused on augmenting Connecticut’s efforts to eliminate gun violence. This particular set is concentrated on the prevention of mass shootings, and it includes:

- Closing loopholes in the state’s assault weapons ban;
- Strengthening penalties related to the state’s ban on large-capacity magazines to make that ban enforceable; and
- Increasing the age to purchase all firearms to 21.

The proposals will be included as part of the governor’s package of priorities for the 2023 legislative session that he will present to the Connecticut General Assembly in February. He announced [the first set of gun violence prevention proposals \(/Office-of-the-Governor/News/Press-Releases/2023/01-2023/Governor-Lamont-Announces-2023-Legislative-Proposal-on-Gun-Violence\)](#), which are focused on eliminating community gun violence, earlier this week. A third set will be announced in the coming days.

“As more and more mass shootings have occurred in the United States over the last decade, federal and state laws have not kept up with the innovative ways firearm companies are manufacturing guns that have the sole purpose of killing the largest number of humans within the shortest amount of time,” **Governor Lamont said.** “I want to be clear – we are not talking about guns that have been created for hunting or protection, but rather the focus here is on assault weapons that are being created for mass human casualty. We’ve shown in Connecticut that we can implement laws that respect the rights of Americans to own guns for their own protection and sportsmanship while also acknowledging that we must take actions to protect public safety. These proposals continue that fair, commonsense balance.”

“Connecticut has the legislative resolve and will to implement laws that respect the rights of responsible gun-owning Americans while closing the loophole on the state’s assault weapons ban that gun manufacturers have exploited at the expense of public safety,” **State Representative Steven Stafstrom, co-chair of the Judiciary Committee, said.** “We also need a strong, enforceable ban on large capacity magazines and to increase the age to purchase all firearms to 21. These are good public policy proposals aimed at preventing terrible tragedies. I thank Governor Lamont for bringing these proposals forward and look forward to a prompt hearing on them before the Judiciary Committee.”

“There have been way too many mass shootings across our country and innocent people are losing their lives,” **State Senator Herron Gaston, co-chair of the legislature’s Public Safety and Security Committee, said.** “We need to take this seriously. We need to work to close the loopholes in our system and strengthen our purchasing laws surrounding all firearms. As co-chair of the Public Safety Committee, I am dedicated to overseeing this legislation that will curb gun violence in Connecticut.”

#### Closing loopholes in the state’s assault weapons ban

Connecticut's existing assault weapons ban, which was adopted in 2013 with significant qualifications in 2014, includes several loopholes that leave a few categories of weapons unregulated. Additionally, firearm manufacturers have made several attempts to skirt these laws by making slight modifications to assault weapons with the intention of excluding them from the ban. To close these loopholes, Governor Lamont is proposing to expand the assault weapons ban to include the following:

- *Pre-September 13, 1994 firearms*: This category is frequently referred to as pre-ban weapons because they refer to the group of assault weapons that have been grandfathered in under Connecticut's 1994 assault weapons ban. Pre-ban weapons include AR-style rifles and are legal to be sold, possessed, and carried into the state whether or not they have forward pistol grips, flash suppressors, barrel shrouds, or other features that were banned under the 2013 law. Gun dealers in other states are known to collect pre-ban weapons and ship them to Connecticut for sale at high prices.
- *So-called "other" weapons*: This category includes those assault weapons in which manufacturers have made attempts to evade the 2013 law through a technical loophole. The 2013 law regulates only pistols, rifles, and shotguns. These are categories that are defined under Connecticut law and do not include all weapons. Several manufacturers are selling weapons specifically designed to fall into this loophole by having a barrel length longer than 12 inches to avoid classification as a pistol and a so-called "pistol brace" on the back to avoid classification as a rifle.
- *Rimfire rifles*: This category includes those assault weapons that are typically used for hunting but are sometimes customized into assault-weapon-style rifles to evade bans like those that have been implemented in Connecticut. These rifles are currently allowed if they have fewer than two banned features.

The governor is proposing to open a new registration period for these weapons to allow current owners to continue possessing them and bar future purchases and sales.

#### **Strengthening penalties related to the state's ban on large-capacity magazines**

In 2013, a law was enacted in Connecticut banning all large-capacity magazines and requiring anyone who already owned such items prior to its enactment to register them with the state. Under existing law, the penalty on a first offense for possession of a large-capacity magazine that was obtained before the 2013 effective date of the ban is an infraction requiring a \$90 fine. Any subsequent offense is a class D felony, which can result in a prison sentence between one to five years and a fine of up to \$5,000. As a result, on a first offense, prosecutors have to prove in court that the magazine was obtained after the 2013 effective date. Because magazines are not serialized like firearms, this is nearly impossible to prove.

Governor Lamont – noting that owners of large-capacity magazines obtained prior to the enactment of this 2013 law have had nearly a decade to register or dispose of those items – is proposing that the first offense provision of this law be eliminated, and all offenses of this statute be considered a class D felony, enabling enforcement of the ban.

#### **Increasing the age to purchase all firearms to 21**

Under existing federal and state laws, anyone seeking to purchase handguns must be 21 or older, and anyone seeking to purchase most types of long guns must be 18 or older. Governor Lamont is proposing to align these age limits by implementing a 21-or-older requirement for the purchase of all types of firearms. These purchase requirements will not impact the ability of anyone under the age of 21 to use firearms as permitted under existing law.

Twitter: [@GovNedLamont \(https://twitter.com/GovNedLamont\)](https://twitter.com/GovNedLamont)

Facebook: [Office of Governor Ned Lamont \(https://www.facebook.com/GovNedLamont\)](https://www.facebook.com/GovNedLamont)

# **Exhibit B**

**AFFIDAVIT OF RAY BEVIS, JR.**

I, Ray Bevis, Jr., being duly sworn, deposes and says:

1. I, Ray Bevis, Jr. am over the age of 18, a citizen of the United States, and I am fully aware of the obligations of the oath.
2. I am an adult resident of Wolcott, CT.
3. I have personal knowledge of the facts stated herein, and if called as a witness, I could competently testify to these facts.
4. I am the Government Relations Representative of the Connecticut Citizens Defense League (“CCDL”) which is a nonprofit, educational foundation, incorporated under the laws of Connecticut with its principal place of business in Stratford, Connecticut. CCDL is a Plaintiff in this action.
5. On January 2, 2020, I requested information under the Connecticut Freedom of Information Act (“FOIA”) from the Special Licensing & Firearms Unit (“SLFU”) of the Department of Emergency Services and Public Protection (“DESPP”). Attached as **Exhibit 1** is a true and accurate copy of the January 2, 2020 FOIA request I sent to SLFU.
6. A few days after I sent my FOIA request to SLFU, I received a letter dated January 6, 2020 from the Legal Affairs Unit of DESPP, acknowledging receipt of my FOIA request. Attached as **Exhibit 2** is a true and accurate copy of said letter.
7. On January 10, 2020, I received an email from Carmen A. Rodriguez, Paralegal for the Legal Affairs Unit containing DESPP’s responses to my January 2, 2020 FOIA request. Attached as **Exhibit 3** is a true and accurate copy of said .
8. Pursuant to Conn. Gen. Stat. § 53-202d, no “assault weapons” could legally be registered (except for some very narrow exceptions) after January 1, 2014. Thus, the number of



“assault weapons” disclosed by SLFU in response to my January 2, 2020 FOIA request, 53,849, should be the same, or close to that number today.

9. On January 12, 2023, I sought additional information under FOIA from the SLFU. Attached as **Exhibit 4** is a true and accurate copy of said request.

10. Pursuant to my January 12, 2023 request, I received a letter from the Legal Affairs Unit of DESPP, acknowledging receipt of my request. Attached as **Exhibit 5** is a true and accurate copy of that document.

11. On January 13, 2023, I sent DESPP’s Legal Affairs Unit an email amending my January 12, 2023 FOIA request, adding a request for information regarding 2022, which I had neglected to include in my original FOIA request. Attached as **Exhibit 6** is a true and accurate copy of my updated request.

12. Later on January 13, 2023, DESPP’s Legal Affairs Unit responded to my email, agreeing to add my amendment to my original FOIA request. Attached as **Exhibit 7** is a true and accurate copy of said email.

13. On January 17, 2023, I received an email from Imisa Rivera, Unit Supervisor of SLFU containing SLFU’s responses to my January 12 and January 13 FOIA requests. Attached as **Exhibit 8** is a true and accurate copy of said email.

14. Based on SLFU’s responses to my FOIA requests, 1,306,867 firearms were in the state weapons registry database through 2021.

15. Based on SLFU’s responses to my FOIA requests, of the 1,306,867 firearms in the state weapons registry database through 2021, 53,849 (approximately 4.1%) were classified as “assault weapons.”

16. Based on SLFU's responses to my FOIA requests, of the 1,306,867 firearms in the state weapons registry database through 2021, 88,766 (approximately 6.8%) were classified as "other" firearms.

17. Pursuant to Conn. Agencies Regs. 29-36m-6, a person seeking to purchase a firearm in Connecticut must submit a Form DPS-3-C and obtain an authorization number prior to being legally authorized to purchase a particular firearm.

18. Based on SLFU's responses to my FOIA requests, in all of 2022, SLFU received 168,808 requests for DPS-3-C authorization numbers.

19. Further affiant sayeth not.

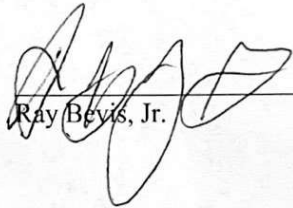
  
Ray Bevis, Jr.

Subscribed and sworn to, before me  
this 3<sup>rd</sup> day of February, 2023

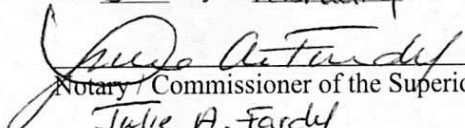
  
Notary Commissioner of the Superior Court  
Julie A. Fardy  
expires 4/30/24



# **Exhibit 1**



Ray Bevis <raybevisjr@gmail.com>

---

## FOI request

1 message

---

**Ray** <raybevisjr@gmail.com>

Thu, Jan 2, 2020 at 12:41 PM

To: despp.legal@ct.gov

Bcc: Ray Bevis <legislative@ccdli.us>

To Whom it May Concern,

I requesting information about the number of active permits and the number of firearms and declared magazines. Please refer to my questions below.

Thank you for your time in advance.

Ray Bevis

- 1) How many active resident permit to carry pistols or revolvers?
- 2) How many active non-resident permit to carry pistols or revolvers?
- 3) How many active eligibility certificates for pistols and revolvers?
- 4) How many active eligibility certificates for the purchase of long guns?
- 5) How many active ammunition certificates?
- 6) How many registered assault weapons are in CT?
- 7) How many declared large capacity magazines are in CT?
- 8) How many firearms are in the state weapons registry database?

--

## **Exhibit 2**



**STATE OF CONNECTICUT**  
**DEPARTMENT OF EMERGENCY SERVICES AND PUBLIC PROTECTION**  
**LEGAL AFFAIRS UNIT**

*Freedom of Information Act Request Response*

January 6, 2020

Mr. Ray Bevis  
raybevisjr@gmail.com

**RE: Your Freedom of Information Act Request**

Dear Mr. Bevis:

Your request for information has been referred to this office for review and response and will be processed in accordance with the provisions of the Freedom of Information Act and any other applicable provision of law.

Pursuant to statute, you may be charged with a fee for an item or service in connection with your request.

Please reference the file number indicated below on all communications to this agency to ensure timely processing of your request.

You will be notified as soon as possible of the results of our review as well as any fees that may be due.

Very truly yours,

*Legal Affairs Unit*

File No.: F-20-03795

*1111 Country Club Road*  
*Middletown, CT 06457*  
*Phone: (860) 685-8150/Fax: (860) 685-8611*  
*An Affirmative Action/Equal Opportunity Employer*

# **Exhibit 3**





**STATE OF CONNECTICUT**  
**DEPARTMENT OF EMERGENCY SERVICES AND PUBLIC PROTECTION**  
**LEGAL AFFAIRS UNIT**

January 10, 2020

Via Email Transmission - [raybevisjr@gmail.com](mailto:raybevisjr@gmail.com)

Mr. Ray Bevis

**RE: Your Freedom of Information Act Request**

Dear Mr. Bevis:

Below please find the response to your Freedom of Information Act requests dated January 2, 2020.

1. How many active resident permit to carry pistols or revolvers? 272,465
2. How many active non-resident permit to carry pistols or revolvers? 16,695
3. How many active eligibility certificates for pistol and revolvers? 169
4. How many active eligibility certificates for the purchase of long guns? 1,357
5. How many active ammunition certifications? 3,008
6. How many registered assault weapons are in CT? 53,849
7. How many declared large capacity magazines are in CT? 2,663,417
8. How many firearms are in the state weapons registry database? 1,772,213

Please reference the file number indicated below on all communications to this agency to ensure proper handling of your request.

Should you have any questions concerning this matter, please do not hesitate to call this office at (860) 685-8150.

Very truly yours,

A handwritten signature in black ink, appearing to read "CAR" followed by a stylized flourish.

Carmen A. Rodriguez, Paralegal  
Legal Affairs Unit

CAR:car  
Enclosure

File No.: F-20-03795

*1111 Country Club Road  
Middletown, CT 06457  
Phone: (860) 685-8150/Fax: (860) 685-8611  
An Affirmative Action/Equal Opportunity Employer*



**Rodriguez, C**

---

**From:** Ray <raybevisjr@gmail.com>  
**Sent:** Thursday, January 2, 2020 12:42 PM  
**To:** DESPP.Legal  
**Subject:** FOI request

To Whom it May Concern,

I requesting information about the number of active permits and the number of firearms and declared magazines. Please refer to my questions below.

Thank you for your time in advance.

Ray Bevis

- 1) How many active resident permit to carry pistols or revolvers?
- 2) How many active non-resident permit to carry pistols or revolvers?
- 3) How many active eligibility certificates for pistols and revolvers?
- 4) How many active eligibility certificates for the purchase of long guns?
- 5) How many active ammunition certificates?
- 6) How many registered assault weapons are in CT?
- 7) How many declared large capacity magazines are in CT?
- 8) How many firearms are in the state weapons registry database?

--

## **Exhibit 4**



Ray Bevis <raybevisjr@gmail.com>

---

## FOIA Request- DESPP/SFLU

1 message

---

Ray <raybevisjr@gmail.com>

Thu, Jan 12, 2023 at 11:52 AM

To: "DESPP.Legal" <DESPP.Legal@ct.gov>

Bcc: Ray Bevis <legislative@ccd.us>, Tom%20Maloney <maloneyta@comcast.net>

To Whom it May Concern;

Wishing you and your team a happy and healthy new year.

I'm seeking information under a FOIA request regarding the questions listed below.

Thank you in advance for your time and response.

Best regards,

Ray Bevis

- 1) How many active resident permits to carry pistols or revolvers are there?
- 2) How many of those active permits to carry a pistol or revolver are males?
- 3) How many of those active permits to carry a pistol or revolver are females?
- 4) How many active permits to carry a pistol or revolver are of the race of Asian?
- 5) How many active permits to carry a pistol or revolver are of the race of Black?
- 6) How many active permits to carry a pistol or revolver are of the race of Indian?
- 7) How many active permits to carry a pistol or revolver are of the race of White?
- 8) How many active permits to carry a pistol or revolver are of the race of unknown?
- 9) How many active permits to carry a pistol or revolver are of the race of Black and male?
- 10) How many active permits to carry a pistol or revolver are of the race of Black and female?
- 11) How many active permits to carry a pistol or revolver are of the race of White and female?
- 12) How many active permits to carry a pistol or revolver are of the race of white and male?
- 13) How many active non-resident permits to carry pistols or revolvers?
- 14) How many active eligibility certificates for pistols or revolvers?
- 15) How many active eligibility certificates for the purchase of long guns?
- 16) How many active ammunition certificates?
- 17) How many firearms are in the state weapons registry database?
- 18) How many firearms are in the state weapons registry database that are classified as "other"?
- 19) How many requests did SLFU receive for DPS-3-C authorization numbers in 2021?
- 20) How many requests did SLFU receive for DPS-3-C authorization numbers through the automated "interactive Voice Response" in 2021?
- 21) How many requests did SLFU receive for DPS-3-C authorization numbers through the automated internet/online system in 2021?
- 22) How many temporary denials were issued in 2021?
- 23) How many unique serial numbers (DESPP-419-C) has DESPP issued since the passage of PA 19-6?
- 24) Under PA 22-115 (effective October 1, 2022), how many times did DESPP notify a municipality for a failed background check when trying to purchase a firearm?

Thank you, Again.

## **Exhibit 5**



**STATE OF CONNECTICUT**  
**DEPARTMENT OF EMERGENCY SERVICES AND PUBLIC PROTECTION**  
**LEGAL AFFAIRS UNIT**

*Freedom of Information Act Request Response*

January 12, 2023

Mr. Ray Bevis  
19 Brookdale St.  
Wolcott, CT 06716

**RE: Your Freedom of Information Act Request**

Dear Mr. Bevis:

Your request for information has been referred to this office for review and response and will be processed in accordance with the provisions of the Freedom of Information Act and any other applicable provision of law.

Pursuant to statute, you may be charged with a fee for an item or service in connection with your request.

Please reference the file number indicated below on all communications to this agency to ensure timely processing of your request.

You will be notified as soon as possible of the results of our review as well as any fees that may be due.

Very truly yours,

*Legal Affairs Unit*

File No.: F-23-08815

*1111 Country Club Road  
Middletown, CT 06457  
Phone: (860) 685-8150/Fax: (860) 685-8611  
An Affirmative Action/Equal Opportunity Employer*

## **Exhibit 6**



Ray Bevis <raybevisjr@gmail.com>

---

**RE: FOIA request**

1 message

---

**DESPP.Legal** <DESPP.Legal@ct.gov>  
To: Ray <raybevisjr@gmail.com>

Fri, Jan 13, 2023 at 2:55 PM

Good Afternoon,

We will add it to the request.

Thank you,

Legal Affairs Unit

Department of Emergency Services and Public Protection

860-685-8150



---

**From:** Ray <raybevisjr@gmail.com>  
**Sent:** Friday, January 13, 2023 2:21 PM  
**To:** DESPP.Legal <DESPP.Legal@ct.gov>  
**Subject:** FOIA request

EXTERNAL EMAIL: This email originated from outside of the organization. Do not click any links or open any attachments unless you trust the sender and know the content is safe.

Dear Legal Affairs,

On 1/12, I requested some information under FOIA (File No: F-23-08815).

Unfortunately, I failed to add the current year to my last request.

Would you be so kind to either amend my last request to add the questions below or accept this email as a second FOIA request?

I do apologize for any inconvenience.

Sincerely,

Ray Bevis

19 Brookdale St, Wolcott, CT 06716

1) How many requests did SLFU receive for DPS-3-C authorization numbers in **2022**?

2) How many requests did SLFU receive for DPS-3-C authorization numbers through the automated "interactive Voice Response" in **2022**?

3) How many requests did SLFU receive for DPS-3-C authorization numbers through the automated internet/online system in **2022**?

4) How many temporary denials were issued in **2022**?



# **Exhibit 7**



Ray Bevis <raybevisjr@gmail.com>

---

**RE: FOIA request**

1 message

---

**DESPP.Legal** <DESPP.Legal@ct.gov>  
To: Ray <raybevisjr@gmail.com>

Fri, Jan 13, 2023 at 2:55 PM

Good Afternoon,

We will add it to the request.

Thank you,

Legal Affairs Unit

Department of Emergency Services and Public Protection

860-685-8150



---

**From:** Ray <raybevisjr@gmail.com>  
**Sent:** Friday, January 13, 2023 2:21 PM  
**To:** DESPP.Legal <DESPP.Legal@ct.gov>  
**Subject:** FOIA request

EXTERNAL EMAIL: This email originated from outside of the organization. Do not click any links or open any attachments unless you trust the sender and know the content is safe.

Dear Legal Affairs,

On 1/12, I requested some information under FOIA (File No: F-23-08815).

Unfortunately, I failed to add the current year to my last request.

Would you be so kind to either amend my last request to add the questions below or accept this email as a second FOIA request?

I do apologize for any inconvenience.

Sincerely,

Ray Bevis

19 Brookdale St, Wolcott, CT 06716

1) How many requests did SLFU receive for DPS-3-C authorization numbers in **2022**?

2) How many requests did SLFU receive for DPS-3-C authorization numbers through the automated "interactive Voice Response" in **2022**?

3) How many requests did SLFU receive for DPS-3-C authorization numbers through the automated internet/online system in **2022**?

4) How many temporary denials were issued in **2022**?

## **Exhibit 8**



Ray Bevis <raybevisjr@gmail.com>

---

**RE: FOIA Request- DESPP/SFLU**

1 message

---

**Rivera, Imisa** <Imisa.Rivera@ct.gov>

Tue, Jan 17, 2023 at 9:48 AM

To: Ray <raybevisjr@gmail.com>

Cc: "Lussier, Christina" <Christina.Lussier@ct.gov>, "Maurice, Brianna" <Brianna.Maurice@ct.gov>

Sir:

See answers to your FOIA Request below.

Let us know if you have any questions.

- 1) How many active resident permits to carry pistols or revolvers are there? **327,394**
- 2) How many of those active permits to carry a pistol or revolver are males? **241,371**
- 3) How many of those active permits to carry a pistol or revolver are females? **86,002**
- 4) How many active permits to carry a pistol or revolver are of the race of Asian? **4,976**
- 5) How many active permits to carry a pistol or revolver are of the race of Black? **27,556**
- 6) How many active permits to carry a pistol or revolver are of the race of Indian? **527**
- 7) How many active permits to carry a pistol or revolver are of the race of White? **288,344**
- 8) How many active permits to carry a pistol or revolver are of the race of unknown? **5,990**
- 9) How many active permits to carry a pistol or revolver are of the race of Black and male? **18,912**
- 10) How many active permits to carry a pistol or revolver are of the race of Black and female? **8,642**
- 11) How many active permits to carry a pistol or revolver are of the race of White and female? **73,941**
- 12) How many active permits to carry a pistol or revolver are of the race of white and male? **214,385**
- 13) How many active non-resident permits to carry pistols or revolvers? **21,891**
- 14) How many active eligibility certificates for pistols or revolvers? **183**
- 15) How many active eligibility certificates for the purchase of long guns? **1,882**
- 16) How many active ammunition certificates? **2253**
- 17) How many firearms are in the state weapons registry database? **1,306,867**
- 18) How many firearms are in the state weapons registry database that are classified as "other"? **88,766**
- 19) How many requests did SLFU receive for DPS-3-C authorization numbers in 2021? **169,765**
- 20) How many requests did SLFU receive for DPS-3-C authorization numbers through the automated "interactive Voice Response" in 2021? **DOES NOT EXSIST**

21) How many requests did SLFU receive for DPS-3-C authorization numbers through the automated internet/online system in 2021? **20,656**

22) How many temporary denials were issued in 2021? **25**

23) How many unique serial numbers (DESPP-419-C) has DESPP issued since the passage of PA 19-6? **56**

24) Under PA 22-115 (effective October 1, 2022), how many times did DESPP notify a municipality for a failed background check when trying to purchase a firearm? **Not sure what failed means?**

#### **Addendum to original FOIA**

1) How many requests did SLFU receive for DPS-3-C authorization numbers in **2022?** **168,808**

2) How many requests did SLFU receive for DPS-3-C authorization numbers through the automated "interactive Voice Response" in **2022?** **DOES NOT EXIST**

3) How many requests did SLFU receive for DPS-3-C authorization numbers through the automated internet/online system in **2022?** **89,846**

4) How many temporary denials were issued in **2022?** **361**

*Imisa Rivera*

Unit Supervisor

Special Licensing & Firearms Unit

1111 Country Club Road

Middletown, CT 06457

Ph 860-685-8011

Fx 860-685-8496

Imisa.Rivera@ct.gov



---

**From:** Ray <raybevisjr@gmail.com>  
**Sent:** Thursday, January 12, 2023 11:52 AM  
**To:** DESPP.Legal <DESPP.Legal@ct.gov>  
**Subject:** FOIA Request- DESPP/SFLU

EXTERNAL EMAIL: This email originated from outside of the organization. Do not click any links or open any attachments unless you trust the sender and know the content is safe.

To Whom it May Concern;

Wishing you and your team a happy and healthy new year.

I'm seeking information under a FOIA request regarding the questions listed below.

Thank you in advance for your time and response.

Best regards,

Ray Bevis

- 1) How many active resident permits to carry pistols or revolvers are there?
- 2) How many of those active permits to carry a pistol or revolver are males?
- 3) How many of those active permits to carry a pistol or revolver are females?
- 4) How many active permits to carry a pistol or revolver are of the race of Asian?
- 5) How many active permits to carry a pistol or revolver are of the race of Black?
- 6) How many active permits to carry a pistol or revolver are of the race of Indian?
- 7) How many active permits to carry a pistol or revolver are of the race of White?
- 8) How many active permits to carry a pistol or revolver are of the race of unknown?
- 9) How many active permits to carry a pistol or revolver are of the race of Black and male?
- 10) How many active permits to carry a pistol or revolver are of the race of Black and female?
- 11) How many active permits to carry a pistol or revolver are of the race of White and female?
- 12) How many active permits to carry a pistol or revolver are of the race of white and male?
- 13) How many active non-resident permits to carry pistols or revolvers?
- 14) How many active eligibility certificates for pistols or revolvers?
- 15) How many active eligibility certificates for the purchase of long guns?
- 16) How many active ammunition certificates?
- 17) How many firearms are in the state weapons registry database?
- 18) How many firearms are in the state weapons registry database that are classified as "other"?
- 19) How many requests did SLFU receive for DPS-3-C authorization numbers in 2021?
- 20) How many requests did SLFU receive for DPS-3-C authorization numbers through the automated "interactive Voice Response" in 2021?
- 21) How many requests did SLFU receive for DPS-3-C authorization numbers through the automated internet/online system in 2021?
- 22) How many temporary denials were issued in 2021?
- 23) How many unique serial numbers (DESPP-419-C) has DESPP issued since the passage of PA 19-6?
- 24) Under PA 22-115 (effective October 1, 2022), how many times did DESPP notify a municipality for a failed background check when trying to purchase a firearm?

Thank you, Again.



# **Exhibit C**

**AFFIDAVIT OF HOLLY SULLIVAN**

I, Holly Sullivan, being duly sworn, deposes and says:

1. I, Holly Sullivan, am an adult resident of Southbury, CT.

2. I am over the age of 18, a citizen of the United States, and I am fully aware of the obligations of the oath.

3. I have personal knowledge of the facts stated herein, and if called as a witness, I could competently testify to these facts.

4. I am the President of the Connecticut Citizens Defense League (“CCDL”) which is a nonprofit, educational foundation, incorporated under the laws of Connecticut, with its principal place of business in Stratford, Connecticut. CCDL is a Plaintiff in this action.

5. CCDL’s mission is to preserve the effectiveness of the Second Amendment through legislative and grassroots advocacy, outreach, education, research, publication, legal action, and programs focused on the constitutional right to keep and bear arms. CCDL has over 41,000 members and supporters nationwide, with more than ninety-five percent of its members and supporters being residents of Connecticut. CCDL represents its members and supporters – which include individuals seeking to exercise their right to acquire, possess, and carry firearms for personal protection.

6. Modern sporting arms are among those listed or described in Conn. Gen. Stat. § 53-202a and effectively “banned” by Conn. Gen. Stat. § 53-202c.

7. I have been contacted by many CCDL members from across Connecticut who own no firearms listed or described in Conn. Gen. Stat. § 53-202a because they are prohibited by Conn. Gen. Stat. § 53-202c from buying or possessing any such firearms.

8. Many of our members would like to be able to lawfully purchase and possess one or more of the firearms listed or described in Conn. Gen. Stat. § 53-202a for defensive purposes, but

are prohibited from doing so by Conn. Gen. Stat. § 53-202c and the risk that the Defendants will enforce Conn. Gen. Stat. § 53-202c against the CCDL members.

9. I am aware that the federal Bureau of Alcohol, Tobacco, Firearms, and Explosives (“ATF”) has promulgated and published a new rule which redesignates certain firearms, which had previously been considered “any other firearm,” or “others” as either rifles or pistols.

10. ATF’s new rule was published in the Federal Register, and thus became effective, on Tuesday, January 31, 2023.

11. Many of CCDL’s members currently own firearms that have previously been classified as “others” in Connecticut, which are subject to the ATF’s new rule.

12. Despite CCDL’s efforts to inform itself and its members on the issue, CCDL has been unable to determine if this federal redesignation changes the legal status of “others” as of January 31, 2023, from perfectly legal “others” in Connecticut, to banned and illegal “assault weapons” under Conn. Gen. Stat. § 53-202a.

13. The difference between them is the difference between CCDL members remaining law-abiding citizens, and being felons, all without them taking any affirmative action.

14. Many of the CCDL members with whom I have spoken wish, and intend, to lawfully keep Connecticut “others” for the purposes of self-defense and recreation as they have done since they lawfully purchased their “others.”

15. I ask that the Court issue a Temporary Restraining Order restraining the Defendants in *Grant v. Lamont*, and those working under them, from taking any action to enforce the state’s “assault weapon” ban against CCDL members and the many thousands of other people who own or would like to own firearms commonly described and designated as “others.”

16. I further ask that the Court issue a Preliminary Injunction enjoining the Defendants in *Grant v. Lamont*, and those working under them, from taking any action to enforce the state’s

“assault weapon” ban against CCDL members and the many thousands of other people who own or would like to own firearms listed or described in Conn. Gen. Stat. § 53-202a.

17. Further affiant sayeth not.

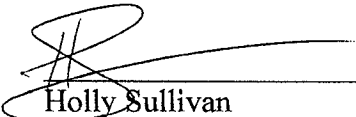
  
\_\_\_\_\_  
Holly Sullivan

Subscribed and sworn to, before me  
this 3<sup>rd</sup> day of February, 2023

YENDRI AZOLAS  
Notary Public  
Connecticut  
My Commission Expires Dec 31, 2024

  
\_\_\_\_\_  
Notary / Commissioner of the Superior Court

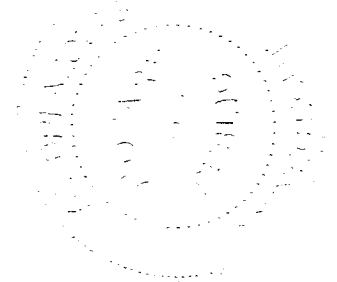

# **Exhibit D**

**AFFIDAVIT OF EDDIE W. GRANT, JR.**

I, Eddie W. Grant, Jr., being duly sworn, deposes and says:

1. I am over 18 years of age and understand the obligations of an oath.
2. I have personal knowledge of the facts stated herein, and if called as a witness, I could competently testify to these facts.
3. I am a retired Connecticut Department of Corrections officer, and I maintain my permanent residence in Meriden, Connecticut.
4. I am one of the individual Plaintiffs in *Grant et al v. Lamont et al.*, 3:22-cv-01223-JBA. I submit this affidavit in support of the Plaintiffs' Emergency Motion for A Temporary Restraining Order and Preliminary Injunction in *Grant v. Lamont*.
5. I have held a Connecticut pistol permit for over 30 years, and I meet all the legal qualifications under federal and state law to acquire and possess firearms, ammunition, and magazines.
6. I am a member of both the Connecticut Citizens Defense League, Inc. ("CCDL") and the Second Amendment Foundation, Inc. ("SAF").
7. I served as a uniformed Corrections officer for twenty-one years, and I retired in 2011. During my service, I worked at facilities such as Cheshire Correctional Institution (a Level 4 facility); Manson Youth Institution (a Level 4 facility); Carl Robinson Correctional Institution (a Level 3 facility); and Webster Correctional Institution (a Level 2 facility).
8. During my career as a Corrections Officer, my responsibilities included conducting armed transports of high-risk inmates and serving as an armed Perimeter Officer. To carry out both responsibilities, the Department of Corrections trained me on the safe and effective use of AR-15-platform firearms, and it required me to qualify annually as a safe and effective user of AR-15-platform firearms. I repeatedly qualified as a safe and effective user during my career.



9. I wish, and intend, to lawfully purchase, possess a modern sporting arm, such as an AR-15-platform firearm for defensive and recreational purposes in Connecticut. Connecticut law prohibits me from doing so though.

10. I believe that Connecticut's "assault weapons" ban gives criminals and attackers a strong tactical advantage over me, and my own heritage makes me strongly desire an equal chance to defend myself. As an African-American, my parents instilled in me a strong respect for the struggles that we have faced in the United States. My mother grew up in the Deep South during the 1950s-60s, and she witnessed church burnings and experienced racially motivated killings that victimized her family and friends. She instilled in me a respect for the private ownership of effective defensive firearms based on African-Americans' use of them to defend their lives and their civil rights in that tumultuous time.

11. I own no firearms listed or described in Conn. Gen. Stat. § 53-202a because I am prohibited by Conn. Gen. Stat. § 53-202c from buying or possessing any such firearms, and the risk that the Defendants will enforce Conn. Gen. Stat. § 53-202c against me.

12. I would like to be able to lawfully purchase and possess one or more of the firearms listed or described in Conn. Gen. Stat. § 53-202a for defensive purposes.

13. I am aware that the federal Bureau of Alcohol, Tobacco, Firearms, and Explosives ("ATF") has promulgated and published a new rule which redesignates certain firearms, which had previously been considered "any other firearm," or "others" as either rifles or pistols.

14. ATF's new rule was published in the Federal Register, and thus became effective, on Tuesday, January 31, 2023.

15. I currently own firearms that have previously been classified as "others" in Connecticut, which are subject to the ATF's new rule.

16. Despite my efforts to inform myself on the issue, I am unable to determine if this federal redesignation changes the legal status of my firearms, as of January 31, 2023, from perfectly legal "others" in Connecticut, to banned and illegal "assault weapons" under Conn. Gen. Stat. § 53-202a.

17. The difference between them is the difference between remaining a law-abiding citizen, and being a felon, all without me taking any affirmative action.

18. I wish, and intend, to lawfully keep my Connecticut "others" for the purposes of self-defense and recreation as I have done since I purchased them.

19. I ask that the Court issue a Temporary Restraining Order restraining the Defendants in *Grant v. Lamont*, and those working under them, from taking any action to enforce the state's "assault weapon" ban against me and the many thousands of other people who own or would like to own firearms that were previously designated as "others."

20. I further ask that the Court issue a Preliminary Injunction enjoining the Defendants in *Grant v. Lamont*, and those working under them, from taking any action to enforce the state's "assault weapon" ban against me and the many thousands of other people who own or would like to own firearms listed or described in Conn. Gen. Stat. § 53-202a.

21. Further affiant sayeth not.

  
Eddie W. Grant, Jr.

Subscribed and sworn to, before me  
this 3<sup>rd</sup> day of February, 2023

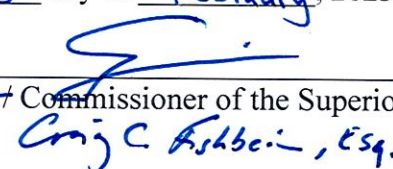
  
Notary / Commissioner of the Superior Court

Craig C. Fishbein, Esq.



# **Exhibit E**

**AFFIDAVIT OF JENNIFER HAMILTON**

I, Jennifer Hamilton, being duly sworn, deposes and says:

1. I am over 18 years of age and understand the obligations of an oath.

2. I have personal knowledge of the facts stated herein, and if called as a witness, I could competently testify to these facts.

3. I maintain my permanent residence in Enfield, Connecticut.

4. I am one of the individual Plaintiffs in *Grant et al v. Lamont et al.*, 3:22-cv-01223-JBA. I submit this affidavit in support of the Plaintiffs' Emergency Motion for A Temporary Restraining Order and Preliminary Injunction in *Grant v. Lamont*.

5. I am the holder of a pistol permit in Connecticut and Massachusetts, and am legally eligible under federal and state law to acquire and possess firearms, ammunition, and magazines.

6. I am a member of both the Connecticut Citizens Defense League, Inc. ("CCDL") and the Second Amendment Foundation, Inc. ("SAF").

7. I am a petite 5'-2" tall woman, and rely on a defensive firearm instead of body strength to protect myself and my family from attack. I have been the victim of domestic violence, and carry a defensive firearm to protect myself and my family from further attack.

8. I am a firearms instructor, teaching students of all skill levels, from their initial pistol permit class to personal defense and tactical firearms use. I am also a Nuisance Wildlife Control Operator trained and licensed by the Connecticut Department of Energy and Environmental Protection.

9. I would like to be able to lawfully purchase one or more modern sporting arms listed or described in Conn. Gen. Stat. § 53-202a, likely an AR15-platform firearm, because of its adaptability and effectiveness for defensive purposes.

10. I would like to purchase and possess such a firearm with a telescopic stock in order to adjust the firearm's length of pull to fit my specific body type and size. However, since Conn. Gen. Stat. § 53-202a(1)(E)(i) defines any such firearm as an "assault weapon," I am prohibited from doing so by Conn. Gen. Stat. § 53-202c.

11. I own no firearms listed or described in Conn. Gen. Stat. § 53-202a because I am prohibited by Conn. Gen. Stat. § 53-202c from buying or possessing any such firearms, and the risk that the Defendants will enforce Conn. Gen. Stat. § 53-202c against me.

12. I would like to be able to lawfully purchase and possess one or more of the firearms listed or described in Conn. Gen. Stat. § 53-202a for defensive purposes.

13. I am aware that the Federal Bureau of Alcohol, Tobacco, Firearms, and Explosives ("ATF") has promulgated and published a new rule which redesignates certain firearms, which had previously been considered "any other firearm," or "others" as either rifles or pistols.

14. ATF's new rule was published in the Federal Register, and thus became effective, on Tuesday, January 31, 2023.

15. I currently own firearms that have previously been classified as "others" in Connecticut, which are subject to the ATF's new rule.

16. Despite my efforts to inform myself on the issue, I am unable to determine if this federal redesignation changes the legal status of my firearms, as of January 31, 2023, from perfectly legal "others" in Connecticut, to banned and illegal "assault weapons" under Conn. Gen. Stat. § 53-202a.

17. The difference between them is the difference between remaining a law-abiding citizen, and being a felon, all without me taking any affirmative action.

18. I wish, and intend, to lawfully keep my Connecticut "others" for the purposes of self-defense and recreation as I have done since I purchased them.

19. I ask that the Court issue a Temporary Restraining Order restraining the Defendants in *Grant v. Lamont*, and those working under them, from taking any action to enforce the state's "assault weapon" ban against me and the many thousands of other people who own or would like to own firearms that were previously designated as "others."

20. I further ask that the Court issue a Preliminary Injunction enjoining the Defendants in *Grant v. Lamont*, and those working under them, from taking any action to enforce the state's "assault weapon" ban against me and the many thousands of other people who own or would like to own firearms listed or described in Conn. Gen. Stat. § 53-202a.

21. Further affiant sayeth not.

  
\_\_\_\_\_  
Jennifer Hamilton

Subscribed and sworn to, before me  
this 3rd day of February, 2023

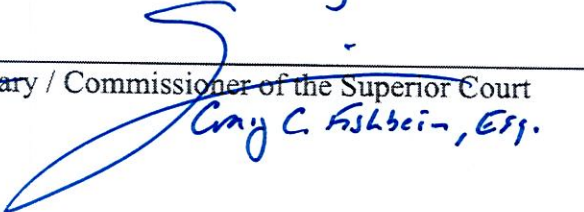
  
\_\_\_\_\_  
Notary / Commissioner of the Superior Court  
Craig C. Fishbein, Esq.

# **Exhibit F**



**AFFIDAVIT OF MICHAEL STIEFEL**

I, Michael Stiefel, being duly sworn, deposes and says:

1. I am over 18 years of age and understand the obligations of an oath.
2. I have personal knowledge of the facts stated herein, and if called as a witness, I could competently testify to these facts.
3. I maintain my permanent residence in Montville, Connecticut.
4. I am one of the individual Plaintiffs in *Grant et al v. Lamont et al.*, 3:22-cv-01223-JBA. I submit this affidavit in support of the Plaintiffs' Emergency Motion for A Temporary Restraining Order and Preliminary Injunction in *Grant v. Lamont*.
5. I have been the holder of a Connecticut pistol permit for over thirty years, and am legally eligible under federal and state law to acquire and possess firearms, ammunition, and magazines.
6. I am a member of both the Connecticut Citizens Defense League, Inc. ("CCDL") and the Second Amendment Foundation, Inc. ("SAF").
7. I served twenty years as a uniformed Corrections Officer with the Connecticut Department of Corrections, during which time I conducted armed transports of high-risk inmates, and was an armed Perimeter Officer carrying an AR-15-platform firearm.
8. During my service with the Department of Corrections, I was trained and qualified by the State of Connecticut in the safe and effective use of AR 15-platform firearms.
9. AR15-platform firearms are among the modern sporting arms listed or described in Conn. Gen. Stat. § 53-202a and effectively "banned" by Conn. Gen. Stat. § 53-202c.
10. I retired from the Department of Corrections in 2010.
11. I own no firearms listed or described in Conn. Gen. Stat. § 53-202a because I am prohibited by Conn. Gen. Stat. § 53-202c from buying or possessing any such firearms.

12. I would like to be able to lawfully purchase and possess one or more of the firearms listed or described in Conn. Gen. Stat. § 53-202a for defensive purposes, but I am prohibited from doing so by Conn. Gen. Stat. § 53-202c and the risk that the Defendants will enforce Conn. Gen. Stat. § 53-202c against me.

13. I am aware that the federal Bureau of Alcohol, Tobacco, Firearms, and Explosives (“ATF”) has promulgated and published a new rule which redesignates certain firearms, which had previously been considered “any other firearm,” or “others” as either rifles or pistols.

14. ATF’s new rule was published in the Federal Register, and thus became effective, on Tuesday, January 31, 2023.

15. I currently own firearms that have previously been classified as “others” in Connecticut, which are subject to the ATF’s new rule.

16. Despite my efforts to inform myself on the issue, I am unable to determine if this federal redesignation changes the legal status of my firearms, as of January 31, 2023, from perfectly legal “others” in Connecticut, to banned and illegal “assault weapons” under Conn. Gen. Stat. § 53-202a.

17. The difference between them is the difference between remaining a law-abiding citizen, and being a felon, all without me taking any affirmative action.

18. I wish, and intend, to lawfully keep my Connecticut “others” for the purposes of self-defense and recreation as I have done since I purchased them.

19. I ask that the Court issue a Temporary Restraining Order restraining the Defendants in *Grant v. Lamont*, and those working under them, from taking any action to enforce the state’s “assault weapon” ban against me and the many thousands of other people who own or would like to own firearms that were previously designated as “others.”

20. I further ask that the Court issue a Preliminary Injunction enjoining the Defendants in *Grant v. Lamont*, and those working under them, from taking any action to enforce the state's "assault weapon" ban against me and the many thousands of other people who own or would like to own firearms listed or described in Conn. Gen. Stat. § 53-202a.

21. Further affiant sayeth not.

  
\_\_\_\_\_  
Michael Stiefel

Subscribed and sworn to, before me  
this 3rd day of February, 2023

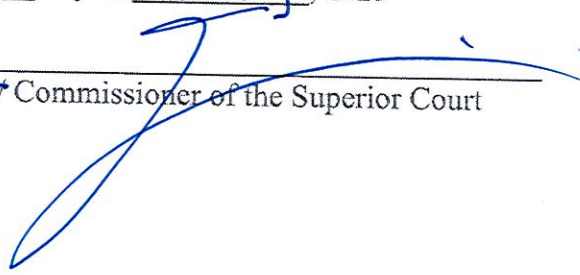
  
\_\_\_\_\_  
~~Notary~~ Commissioner of the Superior Court



# **Exhibit G**



**DECLARATION OF SALAM FATOHI**

I, Salam Fatohi, being duly sworn, deposes and says:

1. I, Salam Fatohi, am over the age of 18, a citizen of the United States, and I am fully aware of the obligations of the oath.

2. I have personal knowledge of the facts stated herein, and if called as a witness, I could competently testify to these facts.

3. I am making this declaration pursuant to 28 U.S.C. § 1746, and I understand that the same obligations that apply to statements made under oath apply to the statements that I make herein.

4. I am currently employed by the National Shooting Sports Foundation (NSSF) – a firearms industry trade association headquartered in Shelton, Connecticut. I am currently NSSF’s Manager for research, and I have held that position since August 2022. Prior to that, I was employed by NSSF as its Manager for Legislative and Policy Research.

5. My responsibilities include, and have included since my employment at NSSF, supervising the collection and compilation of NSSF’s statistical research pertaining to the United States’ firearms industry.

6. Since 1990, the NSSF has tracked the overall domestic production, importation, and exportation of firearms in the United States in its normal course of business.

7. To track the overall domestic production, importation, and exportation of firearms, NSSF relies on publicly available data from the U.S. Bureau of Alcohol, Tobacco, Firearms and Explosives (ATF), various state reporting tools, and data supplied by various private industry manufacturers and distributors. The data that NSSF relies on includes:

- a. Information from the ATF’S Annual Firearms Manufacturing and Exportation Report (AFMER);



b. Data from the U.S. International Trade Commission.

8. Based on my experience as Manager of Research for the NSSF, it is impossible to develop an exact number of how many firearms are owned in the United States, how many people own them, and who owns them. This is due, in large part, to the following factors:

- a. No reliable reporting system is available for historic manufacturing of firearms throughout the United States, which is the biggest hurdle to any estimates.
- b. Detailed reporting systems for firearms ownership are not universal throughout the United States.
- c. No reliable reporting systems exist for determining how many firearms are self-manufactured every year.
- d. No reliable reporting systems exist for determining how many firearms are removed from ownership by private citizens through gun buyback programs, destruction in judicial processes, and other government programs.

9. Based on my experience and the institutional knowledge that I inherited from my predecessors at NSSF, the most reliable estimates of circulating firearms in the United States are derived from statistics pertaining to overall domestic production, importation, and exportation.

10. Additionally, since NSSF only began tracking the overall domestic production, importation, and exportation of firearms in the United States in 1990, the actual number of circulating firearms in the United States is likely higher than NSSF's estimates due to the fact that older firearms may still be in circulation today.

11. The latest industry estimate that NSSF produced for the number of firearms in circulation in the United States was released December 2022. A true and accurate copy of that industry estimate is attached as **Exhibit 1**.



12. NSSF's industry estimate reports that, since 1990, there are approximately 254,752,987 firearms in circulation in the United States.

13. Of those 254.8 million, 77.1 million are rifles. 40.6 million are shotguns. 137.1 million are pistols. Our estimates do not track firearms characterized as "any other firearm" by federal or state governments.

14. Rifles comprise approximately 30.3 percent of firearms in circulation in the United States.

15. NSSF categorizes AR-15-platform and AK-47-platform firearms and other similar variants as "modern sporting rifles," and its research has regularly tracked their overall domestic production, importation, and exportation in the United States.

16. The latest industry estimate that the NSSF produced for the number of modern sporting rifles in circulation in the United States was released on July 20, 2022. A true and accurate copy of that industry estimate is attached as **Exhibit 2**.

17. NSSF's industry estimate reports that, since 1990, approximately 24,446,000 modern sporting rifles have entered circulation in the United States. *See Exhibit 2*.

18. Modern sporting rifles comprise approximately 10 percent of firearms in circulation in the United States.

19. Further declarant sayeth not.

I, Salam Fatohi, declare under penalty of perjury that the foregoing is true and correct.

Executed on February 3, 2023

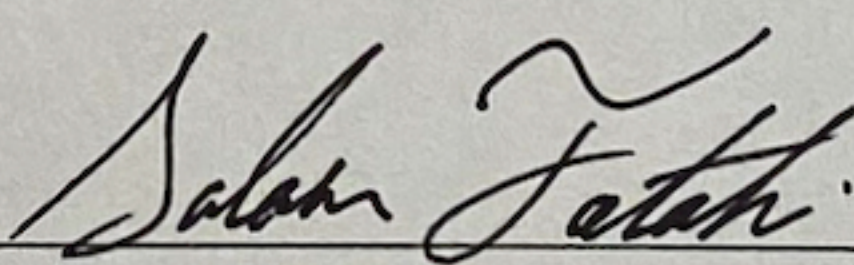
  
\_\_\_\_\_  
Salam Fatohi



# **Exhibit 1**

# Total Firearm Units Produced for the United States Market Annually

Case 3:22-cv-0023-JJA Document 23-1 Filed 02/23/23 Page 6 of 8

YEAR	Handguns Produced in U.S.	Handguns Imported into U.S.	Handguns Exported out of U.S.	Total Handguns	Rifles Produced in U.S.	Rifles Imported into U.S.	Rifles Exported out of U.S.	Total Rifles	Shotguns Produced in U.S.	Shotguns Imported into U.S.	Shotguns Exported out of U.S.	Total Shotguns	TOTAL HANDGUNS, RIFLES & SHOTGUNS	% Change Yoy	YEAR
1990	1,841,922	682,974	191,446	2,333,450	1,211,664	272,709	130,952	1,353,421	855,970	81,228	155,957	781,241	4,468,112	-	1990
1991	1,835,218	692,282	223,248	2,304,252	883,482	348,765	152,647	1,079,600	828,426	98,645	165,574	761,497	4,145,349	-7.2%	1991
1992	2,138,950	876,314	210,358	2,804,906	1,001,833	407,643	152,062	1,257,414	1,018,204	325,345	157,109	1,186,440	5,248,760	26.6%	1992
1993	2,655,654	1,169,123	170,378	3,654,399	1,173,694	749,433	125,694	1,797,433	1,148,939	132,502	175,563	1,105,878	6,557,710	24.9%	1993
1994	2,590,748	1,383,279	195,031	3,778,996	1,316,607	733,277	131,034	1,918,850	1,254,924	142,590	163,031	1,234,483	6,932,329	5.7%	1994
1995	1,722,948	825,127	218,826	2,329,249	1,441,120	286,218	106,504	1,620,834	1,176,958	136,733	125,387	1,188,304	5,138,387	-25.9%	1995
1996	1,486,472	663,801	193,647	1,956,626	1,424,315	234,931	101,961	1,557,285	925,732	145,676	115,555	955,853	4,469,764	-13.0%	1996
1997	1,406,505	1,316,931	146,846	2,576,590	1,251,341	266,869	106,838	1,411,372	915,978	142,067	105,814	952,231	4,940,193	10.5%	1997
1998	1,284,755	590,661	124,295	1,751,121	1,345,899	229,051	85,755	1,489,195	1,036,520	163,663	136,652	1,063,531	4,303,847	-12.9%	1998
1999	1,331,230	677,757	116,467	1,892,520	1,569,685	313,980	69,389	1,814,276	1,106,995	335,489	82,046	1,360,438	5,067,234	17.7%	1999
2000	1,281,861	712,661	80,249	1,914,273	1,583,042	321,316	67,188	1,837,170	898,442	332,704	95,782	1,135,364	4,886,807	-3.6%	2000
2001	946,979	710,958	86,041	1,571,896	1,284,554	322,201	83,671	1,523,084	679,813	428,308	123,430	984,691	4,079,671	-16.5%	2001
2002	1,088,584	971,135	82,338	1,977,381	1,515,286	458,684	102,588	1,871,382	741,325	498,535	133,559	1,106,301	4,955,064	21.5%	2002
2003	1,121,024	762,764	73,337	1,810,451	1,430,324	517,509	102,429	1,845,404	726,078	498,677	95,299	1,129,456	4,785,311	-3.4%	2003
2004	1,022,610	838,856	69,316	1,792,350	1,325,138	491,932	236,525	1,580,545	731,769	507,050	94,854	1,143,965	4,516,660	-5.6%	2004
2005	1,077,630	878,172	80,882	1,874,920	1,431,372	448,862	142,252	1,737,982	709,313	546,261	115,083	1,140,491	4,753,393	5.2%	2005
2006	1,403,329	1,164,973	90,944	2,477,358	1,496,505	516,127	150,493	1,862,139	714,618	607,894	130,310	1,192,202	5,531,699	16.4%	2006
2007	1,610,998	1,387,428	133,774	2,864,652	1,610,923	612,837	220,593	2,003,167	645,231	725,635	157,536	1,213,330	6,081,149	9.9%	2007
2008	1,819,024	1,468,062	151,290	3,135,796	1,746,139	538,283	264,114	2,020,308	630,710	535,960	171,360	995,310	6,151,414	1.2%	2008
2009	2,415,815	2,184,417	162,951	4,437,281	2,253,103	697,800	199,417	2,751,486	752,699	558,679	123,209	1,188,169	8,376,936	36.2%	2009
2010	2,646,504	1,747,635	201,231	4,192,908	1,830,556	466,799	205,950	2,091,405	743,378	509,792	150,956	1,102,214	7,386,527	-11.8%	2010
2011	3,037,112	1,707,313	247,738	4,496,687	2,305,854	656,256	263,223	2,698,887	862,401	530,564	172,770	1,220,195	8,415,769	13.9%	2011
2012	3,978,438	2,591,117	220,923	6,348,632	3,109,940	1,039,716	315,783	3,833,873	949,010	704,828	180,634	1,473,204	11,655,709	38.5%	2012
2013	5,039,832	3,055,329	268,024	7,827,137	3,996,673	1,313,678	363,950	4,946,401	1,203,072	937,952	146,624	1,994,400	14,767,938	26.7%	2013
2014	4,346,624	2,151,591	234,329	6,263,886	3,379,009	706,362	431,890	3,653,481	935,411	648,592	158,471	1,425,532	11,342,899	-23.2%	2014
2015	4,437,613	2,423,182	201,390	6,659,405	3,701,443	708,436	328,395	4,081,484	777,273	644,274	101,656	1,319,891	12,060,780	6.3%	2015
2016	5,562,218	3,614,057	240,642	8,935,633	4,198,692	676,987	266,589	4,609,090	848,615	736,443	81,689	1,503,369	15,048,092	24.8%	2016
2017	4,411,923	3,194,599	278,082	7,328,440	2,821,945	519,400	346,936	2,994,409	667,350	631,998	79,854	1,219,494	11,542,343	-23.3%	2017
2018	4,507,176	2,896,353	400,172	7,003,357	2,905,178	607,209	309,312	3,203,075	536,119	706,634	71,994	1,170,759	11,377,191	-1.4%	2018
2019	3,626,610	2,560,935	230,262	5,957,283	2,062,966	592,146	292,464	2,362,648	480,735	743,474	65,619	1,158,590	9,478,521	-16.7%	2019
2020	6,502,261	3,996,554	458,150	10,040,665	2,761,297	775,852	239,096	3,298,053	476,682	1,490,783	60,027	1,907,438	15,246,156	60.8%	2020
2021 Int.	7,911,658	5,214,791	320,163	12,806,286	3,933,398	1,140,642	83,962	4,990,078	675,450	2,816,308	246,849	3,244,909	21,041,273	38.0%	2021 Int.
<b>TOTAL</b>	<b>88,090,225</b>	<b>55,111,131</b>	<b>6,302,770</b>	<b>137,098,586</b>	<b>65,302,977</b>	<b>17,971,910</b>	<b>6,179,656</b>	<b>77,095,231</b>	<b>26,654,140</b>	<b>18,045,283</b>	<b>4,140,253</b>	<b>40,559,170</b>	<b>254,752,987</b>		

## **Exhibit 2**

# Estimated Modern Sporting Rifles in the United States 1990 – 2020

Year	US Production less exports of MSR/AR platform	US Import less exports of MSR/AR, AK platform	ANNUAL TOTAL
1990	43,000	31,000	74,000
1991	46,000	69,000	115,000
1992	33,000	72,000	105,000
1993	62,000	226,000	288,000
1994	103,000	171,000	274,000
1995	54,000	77,000	131,000
1996	27,000	43,000	70,000
1997	44,000	81,000	125,000
1998	70,000	75,000	145,000
1999	113,000	119,000	232,000
2000	86,000	130,000	216,000
2001	60,000	119,000	179,000
2002	97,000	145,000	242,000
2003	118,000	262,000	380,000
2004	107,000	207,000	314,000
2005	141,000	170,000	311,000
2006	196,000	202,000	398,000
2007	269,000	229,000	498,000
2008	444,000	189,000	633,000
2009	692,000	314,000	1,006,000
2010	444,000	140,000	584,000
2011	653,000	163,000	816,000
2012	1,308,000	322,000	1,630,000
2013	1,882,000	393,000	2,275,000
2014	950,000	237,000	1,187,000
2015	1,360,000	245,000	1,605,000
2016	2,217,000	230,000	2,447,000
2017	1,406,000	158,000	1,564,000
2018	1,731,000	225,000	1,956,000
2019	1,679,000	169,000	1,848,000
2020	2,466,000	332,000	2,798,000
<b>TOTALS</b>	<b>18,901,000</b>	<b>5,545,000</b>	<b>24,446,000</b>



# **Exhibit H**

**DEPARTMENT OF JUSTICE**

**Bureau of Alcohol, Tobacco, Firearms, and Explosives**

**27 CFR Parts 478 and 479**

[Docket No. ATF 2021R-08F; AG Order No. 5589-2023]

RIN 1140-AA55

**Factoring Criteria for Firearms With Attached “Stabilizing Braces”**

**AGENCY:** Bureau of Alcohol, Tobacco, Firearms, and Explosives, Department of Justice.

**ACTION:** Final rule.

**SUMMARY:** The Department of Justice (“Department” or “DOJ”) is amending the regulations of the Bureau of Alcohol, Tobacco, Firearms, and Explosives (“ATF”) to clarify when a rifle is designed, made, and intended to be fired from the shoulder. Specifically, under the Gun Control Act of 1968 (“GCA”) and the National Firearms Act of 1934 (“NFA”) the definition of “rifle” shall include a weapon that is equipped with an accessory, component, or other rearward attachment (e.g., a “stabilizing brace”) that provides surface area that allows the weapon to be fired from the shoulder, provided other factors, as described in this preamble and in the amended regulations, indicate that the weapon is designed, made, and intended to be fired from the shoulder.

**DATES:**

*Effective date:* This rule is effective January 31, 2023.

*Compliance Date:* Any weapons with “stabilizing braces” or similar attachments that constitute rifles under the NFA must be registered no later than May 31, 2023.

**FOR FURTHER INFORMATION CONTACT:**

Denise Brown, Office of Regulatory Affairs, Enforcement Programs and Services, Bureau of Alcohol, Tobacco, Firearms, and Explosives, U.S. Department of Justice, 99 New York Ave. NE, Washington, DC 20226; telephone: (202) 648-7070 (this is not a toll-free number).

**SUPPLEMENTARY INFORMATION:**

- I. Executive Summary
  - A. Summary of Regulatory Action
  - B. Summary of Costs and Benefits
- II. Background
  - A. Authority Under GCA and NFA
  - B. “Stabilizing Brace” Device-Related Classifications
- III. Notice of Proposed Rulemaking
  - A. Definition of “Rifle”
  - B. Application of Proposed ATF Worksheet 4999
- IV. Analysis of Comments and Department Responses

- A. Comments Received in Support
- B. Comments Received in Opposition
- V. Final Rule
  - A. Definition of “Rifle”
  - B. Options for Affected Persons
  - C. Discussion of Tax Forbearance
- VI. Statutory and Executive Order
  - A. Executive Orders 12866 and 13563
  - B. Executive Order 13132
  - C. Executive Order 12988
  - D. Regulatory Flexibility Act
  - E. Small Business Regulatory Enforcement Fairness Act of 1996
  - F. Congressional Review Act
  - G. Unfunded Mandates Reform Act
  - H. Paperwork Reduction Act of 1995

**I. Executive Summary**

*A. Summary of Regulatory Action*

This executive summary provides an overview of the relevant statutory definitions, a brief overview regarding the regulatory background prompting the issuance of a rule, a description of the earlier published notice of proposed rulemaking (“NPRM”), a description of this final rule after consideration of the comments received on the NPRM, and an overview of options for persons affected by this rule. Nothing in this rule bans “stabilizing braces” or the use of “stabilizing braces” on pistols; however, firearms<sup>1</sup> with an attached “brace” device may be subject to statutory and regulatory requirements depending on the firearm’s objective design features and other factors, as discussed in this rule. Furthermore, this rule does not impose any new legal obligations on owners of “stabilizing braces” at all, as any obligations for these owners result only from the NFA and the GCA. Instead, this rule merely conveys more clearly to the public the objective design features and other factors that indicate a weapon is in fact a firearm or short-barreled rifle under the relevant statutes.

The GCA definition of “firearm” is broad and includes “any weapon (including a starter gun) which will or is designed to, or that may be readily converted to, expel a projectile by the action of an explosive.” 18 U.S.C. 921(a)(3)(A). This definition does not include an antique firearm. The GCA additionally provides definitions for the terms “rifle” and “short-barreled rifle.” 18 U.S.C. 921(a)(7), (a)(8). A “rifle” is defined as “a weapon designed or redesigned, made or remade, and intended to be fired from the shoulder and designed or redesigned and made or remade to use the energy of an explosive to fire only a single projectile through a

rifled bore for each single pull of the trigger.” 18 U.S.C. 921(a)(7). A “short-barreled rifle” is defined as “a rifle having one or more barrels less than sixteen inches in length and any weapon made from a rifle (whether by alteration, modification, or otherwise) if such weapon, as modified, has an overall length of less than twenty-six inches.” 18 U.S.C. 921(a)(8). The GCA imposes specific controls on the interstate transport of “short-barreled rifle[s]” and requires Federal firearms licensees (“FFLs”) to receive approval from the Attorney General prior to the sale of a “short-barreled rifle.” 18 U.S.C. 922(a)(4), (b)(4).<sup>2</sup>

The GCA also defines the term “handgun” as “(A) a firearm which has a short stock and is designed to be held and fired by the use of a single hand; and (B) any combination of parts from which a firearm described in subparagraph (A) can be assembled.” 18 U.S.C. 921(a)(30). A pistol, which is a type of handgun, is defined under 27 CFR 478.11 and 479.11 as a weapon originally designed, made, and intended to fire a projectile from one or more barrels when held in one hand that has both a chamber as an integral part of, or permanently aligned with, the bore and a short stock designed to be gripped by one hand at an angle to and extending below the line of the bore.

The NFA defines the term “firearm” differently and more narrowly than does the GCA. Under the NFA, the term “firearm” includes “a rifle having a barrel or barrels of less than 16 inches in length” and “a weapon made from a rifle if such weapon as modified has an overall length of less than 26 inches or a barrel or barrels of less than 16 inches in length” (also known as “short-barreled rifle[s]”) as that term is defined under the GCA). 26 U.S.C. 5845(a)(3)–(4); 18 U.S.C. 921(a)(8). The NFA defines the term “rifle” as “a weapon designed or redesigned, made or remade, and intended to be fired from the shoulder and designed or redesigned and made or remade to use the energy of the explosive in a fixed cartridge to fire only a single projectile through a rifled bore for each single pull of the trigger, and shall include any such weapon which may be readily restored to fire a fixed cartridge.” 26 U.S.C.

<sup>1</sup> Unless otherwise indicated, the term “firearm,” as used in this rule, means “any weapon (including a starter gun) which will or is designed to or may readily be converted to expel a projectile by the action of an explosive.” See 18 U.S.C. 921(a)(3)(A).

<sup>2</sup> The GCA, 18 U.S.C. 922(a)(4), makes it unlawful for any person, other than a licensed importer, licensed manufacturer, licensed dealer, or licensed collector, to transport in interstate or foreign commerce any “short-barreled rifle” except as authorized by the Attorney General consistent with public safety and necessity. Section 922(b)(4) makes it unlawful for any FFL to sell or deliver a “short-barreled rifle” to any person except as authorized by the Attorney General consistent with public safety and necessity.

5845(c). The section of the NFA's definition of "firearm" that includes a "rifle with a barrel or barrels less than 16 inches in length" and a "weapon made from a rifle" is nearly identical to the GCA's definition of "short-barreled rifle."

Firearms falling under the purview of the NFA must be registered in the National Firearms Registration and Transfer Record ("NFRTR") to a person<sup>3</sup> entitled to possess the firearm, 26 U.S.C. 5841; require approval by the Attorney General before their transfer or making, 26 U.S.C. 5812, 5822; and are subject to transfer and making taxes, 26 U.S.C. 5811, 5821. Additionally, any person engaged in the business of importing, manufacturing, or dealing NFA firearms must register with the Attorney General and pay a special (occupational) tax ("SOT"). 26 U.S.C. 5801, 5802. Generally, all "rifles," "weapon[s] made from a rifle," and "rifle[s] having a barrel or barrels of less than 16 inches in length" for purposes of the NFA are also "firearms" under the GCA.

In 2012, an FFL submitted the first "stabilizing brace" (or "brace" device) to ATF asking if the addition of their prototype "brace" device to a heavy pistol,<sup>4</sup> such as an AR-15 type pistol, would change that pistol's classification under Federal firearms laws.<sup>5</sup> The submitter described that the "brace" device was designed with the intent to assist people with disabilities so that they could fire these kinds of heavy pistols safely and comfortably, as they could be "difficult to control with the one-handed precision stance."<sup>6</sup> In response to this inquiry, ATF examined the submitted "stabilizing brace" device and found the sample "provide[d] the shooter with additional support of a

firearm while it is still held and operated with one hand" and that the device was not "designed or intended to fire a weapon from the shoulder." Accordingly, ATF concluded that the submitted "brace," when attached to a firearm, did "not convert that weapon to be fired from the shoulder and would not alter the classification of a pistol or other firearm," and therefore, "such a firearm would not be subject to NFA controls."<sup>7</sup>

Since then, the variety of available "stabilizing braces" or similar "brace" devices and pistols equipped with "braces" has grown significantly. In 2014, ATF began to see "braces" being used to fire weapons from the shoulder and new "brace" designs that included characteristics common to shoulder stocks. ATF's previous classifications had analyzed whether "brace" devices could effectively be used on the forearm for single-handed firing (as the manufacturer claimed). Additionally, for a period of time, many of ATF's classifications did not consider: (1) whether the firearm equipped with a specific "brace" model was designed or redesigned to be fired from the shoulder based on the objective design features of the weapon, or (2) how the firearm equipped with the "brace" was being used in the general community. The diversity of "brace" devices yielded a plethora of firearms with an attached "stabilizing brace" that possess objective design features indicative of firearms designed, made, and intended to be fired from the shoulder.<sup>8</sup> As explained in this rule, because a majority of these firearms with an attached "stabilizing brace" are configured as rifles and have a barrel or barrels of less than 16 inches in length, they fall under the purview of the NFA. Therefore, under the statute and regulations, individuals who attach a "stabilizing brace" to a firearm could find themselves making an NFA firearm without abiding by the registration and taxation requirements of the NFA.

Furthermore, ATF has made clear to makers and manufacturers that despite their purported intent with respect to the use or design of an accessory, the requirements of the NFA cannot be circumvented by attempting to configure a firearm with a purported "stabilizing brace" when the affixed device and configuration of the firearm includes features inherent in shoulder-fired weapons.<sup>9</sup> For these reasons, it is necessary for the Department to amend the regulatory definition of "rifle" to make clear to the public the objective design features and other factors that must be considered when determining whether a firearm equipped with an accessory, component, or other rearward attachment (e.g., a "stabilizing brace") is a rifle designed, made, and intended to be fired from the shoulder. Although ATF will consider a manufacturer's stated intent as reflected in direct and indirect marketing materials or other information demonstrating the likely use of the weapon in the general community in assessing whether the firearm is or is not designed, made, and intended to be fired from the shoulder, the objective design features of the weapon may support or undermine that intent, and the stated intent will not necessarily be dispositive.

On June 10, 2021, the Department published an NPRM in the **Federal Register** titled, "Factoring Criteria for Firearms With Attached 'Stabilizing Braces'," 86 FR 30826. The NPRM proposed amending ATF's definitions of "rifle" in 27 CFR parts 478 and 479 to expressly state that the term may include firearms equipped with a "stabilizing brace," even though such firearms were already implicitly included in the definition by virtue of the fact that they were designed, made, and intended to be fired from the shoulder. The proposed amendment clarified that a firearm equipped with a "stabilizing brace" device falls under the definition of "rifle" if the weapon "has objective design features and characteristics that facilitate shoulder fire," as indicated on ATF Worksheet 4999, Factoring Criteria for Rifled Barrel Weapons with Accessories commonly referred to as "Stabilizing Braces"

<sup>3</sup> The NFA does not define the term "person;" however, the Internal Revenue Code provides that, "[w]hen used in this title, where not otherwise distinctly expressed or manifestly incompatible with the intent thereof . . . [t]he term 'person' shall be construed to mean and include an individual, a trust, estate, partnership, association, company or corporation." 26 U.S.C. 7701(a)(1). NFA regulations similarly define the term "person" at 27 CFR 479.11.

<sup>4</sup> For purposes of the rule, ATF generally refers to the type of firearms that are typically equipped with a "stabilizing brace" as heavy pistols based on the manufacturer's stated intent. The use of the term "pistol" in this rule should not be interpreted as an official classification from ATF that any of these firearms are "pistols" under Federal law. The Department recognizes that, under the final rule titled "Definition of 'Frame or Receiver' and Identification of Firearms," 87 FR 24652 (Apr. 26, 2022), these firearms incorporate a rifle receiver (e.g., AR-15 receiver).

<sup>5</sup> Letter for John Spencer, Chief, Firearms Technology Branch, ATF, from Alex Bosco, NST Global (Nov. 8, 2012).

<sup>6</sup> *Id.*

<sup>7</sup> Letter from ATF #2013-0172 (Nov. 26, 2012) (emphasis omitted).

<sup>8</sup> RecoilTV, *RECOILTV SHOT Show 2020: Angstadt Arms MDP9*, RECOIL Gun Magazine (Jan. 22, 2020), <https://www.recoilweb.com/recoiltv-shot-show-2020-angstadt-arms-mdp9-156974.html>; Gun Talk Media, *Brace or No Brace: Springfield's SAINT AR Pistol | Gun Talk*, YouTube (June 16, 2018), <https://www.youtube.com/watch?v=vPAmDoCovUE>; TFB TV, *Ruger AR-556 Pistol: The New Budget Baseline*, YouTube (Oct. 18, 2019), <https://www.youtube.com/watch?v=oFqD7JONpDU&t=2s>; PersonalDefenseNet, *Shouldering an AR Pistol with a SIG Brace*, YouTube (June 21, 2017), <https://www.youtube.com/watch?v=DvoZxDLA-SM>; Military Arms Channel, *The NFA Nut Kicker!*, YouTube (Apr. 19, 2017), <https://www.youtube.com/watch?v=eol8fvMfEnc>.

<sup>9</sup> See generally ATF Open Letter on the Redesign of "Stabilizing Braces," from Max Kingery, Acting Chief, Firearms Technology Criminal Branch, Firearms and Ammunition Technology Division, ATF (Jan. 16, 2015) ("2015 Open Letter"); Letter for Mark Barnes, Outside Counsel to SB Tactical, LLC from Marvin G. Richardson, Assistant Director, Enforcement Programs and Services, ATF, 90000:GM, 5000, *Re: Reversal of ATF Open Letter on the Redesign of "Stabilizing Braces"* (Mar. 21, 2017); Letter from ATF #309513 (Apr. 11, 2019); Letter from ATF #309921 (May 16, 2019); Letter from ATF #310678 (June 25, 2019).



(“Worksheet 4999”). *Id.* at 30851. The Department published for public comment the criteria ATF considers when evaluating the objective design features of firearms equipped with a “stabilizing brace” to determine whether the weapon is a “rifle” or “short-barreled rifle” under the GCA and a “rifle” or “firearm,” (*i.e.*, a short-barreled rifle) under the NFA. The NPRM also included the proposed Worksheet 4999, which assigned points to various criteria and provided examples of how the Worksheet 4999 would be used to evaluate firearms equipped with certain models of “stabilizing braces.”

After careful consideration of the comments received regarding the complexity in understanding the proposed Worksheet 4999 and the methodology used in the Worksheet to evaluate firearms equipped with a “brace” device, this final rule does not adopt some aspects of the approach proposed in the NPRM, specifically the Worksheet 4999 and its point system. Instead, based on the comments received, the Department took the relevant criteria discussed in the NPRM and Worksheet 4999 that indicate when a firearm is designed, made, and intended to be fired from the shoulder and incorporated them into the rule’s revised definitions of rifle. Because both the GCA and NFA define a “rifle” as a weapon “designed or redesigned, made or remade, and intended to be fired from the shoulder,” the Department believes that a weapon that is equipped with an accessory, component, or other rearward attachment (*e.g.*, a “stabilizing brace”) that provides surface area that allows the weapon to be fired from the shoulder is a rifle, provided the other factors described in this preamble and listed in the final regulatory text indicate the weapon is designed, made, and intended to be fired from the shoulder.

Accordingly, the Department amends the definition of “rifle” under 27 CFR 478.11 and 479.11 to expressly state that the term “designed or redesigned, made or remade, and intended to be fired from the shoulder” includes a weapon that is equipped with an accessory, component, or other rearward attachment (*e.g.*, a “stabilizing brace”) that provides surface area that allows the weapon to be fired from the shoulder, provided other factors, as listed in the amended regulations and described in this preamble, indicate that the weapon is designed, made, and intended to be fired from the shoulder. The other factors are:

(1) Whether the weapon has a weight or length consistent with the weight or length of similarly designed rifles;

(2) Whether the weapon has a length of pull, measured from the center of the trigger to the center of the shoulder stock or other rearward accessory, component or attachment (including an adjustable or telescoping attachment with the ability to lock into various positions along a buffer tube, receiver extension, or other attachment method), that is consistent with similarly designed rifles;

(3) Whether the weapon is equipped with sights or a scope with eye relief that require the weapon to be fired from the shoulder in order to be used as designed;

(4) Whether the surface area that allows the weapon to be fired from the shoulder is created by a buffer tube, receiver extension, or any other accessory, component, or other rearward attachment that is necessary for the cycle of operations;

(5) The manufacturer’s direct and indirect marketing and promotional materials indicating the intended use of the weapon; and

(6) Information demonstrating the likely use of the weapon in the general community.

All of the objective design features and factors listed in the rule that indicate the weapon is designed, made, and intended to be fired from the shoulder are derived from the NPRM and proposed Worksheet 4999.

The revised definition in this final rule clarifies, consistent with the best interpretation of the statutory provision, that firearms with an attached “stabilizing brace” can possess objective design features that make them “rifles,” as that term is defined under the NFA and GCA. If a firearm with an attached “stabilizing brace” meets the definition of a “rifle” based on the factors indicated in this final rule, then that firearm could also be a short-barreled rifle depending on the length of the attached barrel, thus subjecting it to additional requirements under the NFA and GCA. However, a firearm with an attached “brace” device is not a “rifle” as defined in the relevant statutes if the weapon is not designed, made, and intended to be fired from the shoulder. The rule, as proposed and finalized, does not ban “stabilizing braces” or prohibit firearms with an attached “stabilizing brace,” regardless of the firearm’s classification.

This revised definition reflects the Department’s understanding of the best interpretation of the statute, and it is immediately effective. *See* 5 U.S.C. 553(d)(2). In addition, because prior

ATF classifications of firearms equipped with a “brace” device did not all employ this correct understanding of the statutory terms, all such prior classifications are no longer valid as of January 31, 2023. While firearms equipped with “stabilizing braces” or other rearward attachments may be submitted to ATF for a new classification determination, a majority of the existing firearms equipped with a “stabilizing brace” are likely to be classified as “rifles” because they are configured for shoulder fire based on the factors described in this rule. Because many of these firearms generally have a barrel of less than 16 inches, they are likely to be classified as short-barreled rifles subject to regulation and registration under the NFA and GCA.

Consequently, many parties in possession of weapon and “brace” combinations that ATF did not specifically classify in the past as being subject to the NFA may have been violating the NFA by possessing an unregistered rifle with a barrel of less than 16 inches. In addition, where the Department is overruling ATF’s previous classification letters, possessors of the firearms equipped with “stabilizing braces” that were at issue in those letters may also be in possession of unregistered NFA firearms. Prior to the publication of the NPRM and this rule to clarify the regulatory definition of a rifle, many parties did not register these firearms due to a variety of factors discussed in this rule. Therefore, in exercising its enforcement discretion, the Department provides affected persons options that they can choose from by May 31, 2023 to comply with the statutory requirements. For example, possessors of such weapons, whether an unlicensed individual or an FFL (regardless of SOT status), may register the firearms to comply with the statutory requirements. As discussed in section V.B of this preamble, ATF strongly encourages affected parties to use the eForms system (<https://eforms.atf.gov>) to submit an electronic version of the appropriate NFA forms. Any penalties for failure to take the necessary action for these existing firearms to comply with Federal law would result only from conduct occurring after this time period to take action ends.

Provided the registration form is properly submitted and documented within the defined time period, the Department will consider individuals to be in compliance with the statutory requirements between the date on which a person’s application is filed

and the date a person receives ATF approval or disapproval of the application. After the 120-day registration period following publication of this rule, registration of previously made or manufactured weapons with a “stabilizing brace” that constitute NFA firearms will not be permitted. The Department at that time may take enforcement action against any person in possession of an affected firearm that is a short-barreled rifle for which a registration has not been submitted.

Apart from registration, there are other options that are set out in section V.B. of this preamble that include modifying affected weapons to remove them from the definition of a short-barreled rifle, destroying the firearm, or surrendering the firearm to law enforcement. Registering the firearm or modifying the configuration of such a firearm within the defined time period will enable affected persons to lawfully retain possession of their firearm under Federal law. While possessors of such weapons will themselves be able to apply the factors outlined in the amended regulatory text, ATF is publishing information simultaneously with this rule that will inform the public of both (1) common weapon platforms with attached “stabilizing brace” designs and (2) examples of commercially available firearms equipped with a “stabilizing brace” that are short-barreled rifles. Additionally, an individual may contact ATF to receive a determination of whether their firearm equipped with a “stabilizing brace” is a rifle as defined by the GCA and NFA.

The Department has determined that, as a matter of its own enforcement discretion, it will not, as the NPRM suggested as an option, require individuals and FFLs without an SOT that timely register their affected weapons with a “stabilizing brace,” which are in their possession as of the date this rule is published, to pay the \$200 making tax usually due upon submission of such an application to register. Likewise, Type 7 FFLs (regardless of SOT status) that timely register the weapons with a “stabilizing brace” that qualify as an NFA firearm and that are still in their inventory—*i.e.*, that have not been sold or otherwise transferred—will not owe any making tax for these weapons. Furthermore, the Department has determined that, as a matter of its own enforcement discretion, it will not seek to collect retroactive taxes (*i.e.*, \$200 making or \$200 transfer tax) typically required for each weapon with a “stabilizing brace” that qualifies as an NFA firearm that

was manufactured or transferred at any time prior to the date of the publication of this final rule. *See* section V.C.

Notwithstanding the 120-day compliance period, discussed above, the rule is immediately effective in that the Department may seek to enforce the NFA’s requirements with respect to any new making or new transfer of a weapon with an attached “stabilizing brace” that constitutes a short-barreled rifle under the NFA. The Department believes that delaying enforcement of the relevant NFA provisions is not necessary to allow an equitable opportunity for compliance because all persons, through publication of this rule, have received notice that the NFA may in fact apply to their conduct. Further delaying enforcement also would be inconsistent with public safety. Therefore, ATF may enforce the NFA against any person or entity that—any time after the publication date of this rule—newly makes or transfers a weapon with an attached “stabilizing brace” that constitutes a short-barreled rifle under the NFA. For purposes of the Congressional Review Act, however, the Department will wait to actually initiate such enforcement actions for at least 60 days from publication of the rule in the **Federal Register**. *See* 5 U.S.C. 801(a)(3).

#### B. Summary of Costs and Benefits

In sum, ATF anticipates the cost of the rule is \$266.9 million, annualized and discounted at seven percent. The total costs calculated for this rule take into account the various options, described above, that affected parties can choose from to come into compliance with the statutory requirements. The benefit of this rule is preventing manufacturers and individuals from violating the requirements of the NFA and GCA. Congress placed stricter requirements on the making and possession of short-barreled rifles, deeming them to be dangerous and unusual weapons and posing a significant danger to the public, as discussed below. This rule enhances public safety by reducing the further proliferation and criminal use of firearms with attached “stabilizing braces.” Refer to the standalone Final Regulatory Impact Analysis, available on [www.atf.gov](http://www.atf.gov), for a full discussion of the potential costs and benefits of the rule.

## II. Background

### A. Authority Under the GCA and NFA

The Attorney General is responsible for enforcing the GCA, as amended, and

the NFA, as amended,<sup>10</sup> and Congress has included provisions in these statutes that authorize the Attorney General to promulgate regulations as are necessary to enforce the provisions of the GCA and NFA. *See* 18 U.S.C. 926(a); 26 U.S.C. 7801(a)(2)(A), 7805(a).<sup>11</sup> Congress and the Attorney General have delegated the responsibility for administering and enforcing the GCA and NFA to the Director of ATF, subject to the direction of the Attorney General and the Deputy Attorney General. *See* 26 U.S.C. 7801(a)(2); 28 U.S.C. 599A(b)(1), (c)(1); 28 CFR 0.130(a)(1)–(2); T.D. Order No. 221(2)(a), (d), Establishment, Organization, and Functions, 37 FR 11696–97 (June 10, 1972). Accordingly, the Department and ATF have promulgated regulations to implement the GCA and NFA. *See* 27 CFR parts 478, 479.

The ATF Director delegated the authority to classify firearms pursuant to the GCA and NFA to ATF’s Firearms Technology Criminal Branch (“FTCB”) and the Firearms Technology Industry Services Branch (“FTISB”). Both FTCB and FTISB fall under the Firearms and Ammunition Technology Division (“FATD”), Office of Enforcement Programs and Services.<sup>12</sup> FATD supports the firearms industry and the general public by, among other things, responding to technical inquiries and testing and evaluating firearms voluntarily submitted to ATF for a determination of a firearm’s classification under the GCA or NFA. There is no requirement that members of the firearms industry or the public submit firearms to ATF for evaluation of the firearm’s classification under Federal law.<sup>13</sup>

The statutory definitions of “firearm” under the GCA and the NFA are different.<sup>14</sup> The definition of “firearm” under the GCA is broad and encompasses almost all weapons defined as a “firearm” under the NFA

<sup>10</sup> NFA provisions still refer to the “Secretary of the Treasury.” *See generally* 26 U.S.C. ch. 53. However, the Homeland Security Act of 2002, Public Law 107–296, 116 Stat. 2135, transferred the functions of ATF from the Department of the Treasury to the Department of Justice, under the general authority of the Attorney General. 26 U.S.C. 7801(a)(2); 28 U.S.C. 599A(c)(1). Thus, for ease of reference, this rule refers to the Attorney General throughout.

<sup>11</sup> *See also* section IV.B.1.a, *infra*.

<sup>12</sup> DOJ, Delegation of Authorities Within the Bureau of Alcohol, Tobacco, Firearms and Explosives, Delegation Order 1100.168C (Nov. 5, 2018).

<sup>13</sup> The only exception is in cases of a conditional import under an exception to the general importation restrictions under the GCA and NFA. *See* 18 U.S.C. 922(l); 26 U.S.C. 5844; 27 CFR 478.116; 479.113.

<sup>14</sup> 18 U.S.C. 921(a)(3) (GCA definition of firearm); 26 U.S.C. 5845(a) (NFA definition of firearm).

because they may expel a projectile by the action of an explosive. However, when Congress passed the NFA in 1934, it chose to regulate certain “gangster-type weapons” more stringently than other firearms because they were viewed as especially dangerous and unusual.<sup>15</sup> Congress chose to define such weapons as “firearms”; hence, the NFA’s definition of “firearm” is narrower than the GCA’s definition of “firearm” in that it captures only particular types of weapons, for example, machineguns, short-barreled rifles, and short-barreled shotguns.

A “firearm” under the NFA is subject not only to general GCA requirements but is further subject to making and transfer taxes and must be registered with ATF in the NFRTR. *See* 26 U.S.C. 5811–5812, 5821–5822, 5841, 5845. In addition to the NFA requirements, the GCA also imposes specific restrictions on the transportation, sale, and delivery of “short-barreled rifle[s]” and “short-barreled shotgun[s].” 18 U.S.C. 922(a)(4), (b)(4). These violations under the GCA are punishable by up to five years in prison and a fine of up to \$250,000. *See* 18 U.S.C. 924(a)(1), 3571. Violations of the NFA are punishable by up to 10 years in prison and a fine of up to \$10,000. 26 U.S.C. 5871.

Although it is not mandatory, many FFLs voluntarily submit classification requests to ATF because FATD’s classification of a particular firearm allows industry members to plan, develop, and distribute products in compliance with the law. This can reduce their risk of incurring criminal or civil penalties, or the potential for costly corrective actions, including a possible

<sup>15</sup> Congress chose to regulate these firearms by taxing them. Therefore, the NFA is part of the Internal Revenue Code. Courts have recognized that NFA firearms are dangerous and unusual, and that possession of unregistered firearms poses a danger to the community. For a description of the relevant case law, see *infra* section IV.A.2.

recall by the manufacturer. Classifications provide the submitter a written determination by ATF of how the laws and regulations apply to their specific firearm.

When FATD evaluates a submitted firearm sample, it examines the overall configuration, physical characteristics, other objective design features that are relevant under the statutory definitions of the NFA and GCA, and any other information that directly affects the classification of a particular firearm configuration as presented with that sample.<sup>16</sup> The numerous configurations, materials, and designs of modern firearms require thorough examination and consideration to ensure an accurate classification. Even though firearms may have a similar appearance (*e.g.*, shape, size, etc.), an ATF classification of a voluntarily submitted sample pertains only to the particular sample as originally configured when submitted because of the vast number of variations that are possible in respective submissions. *See* 27 CFR 478.92(c), 479.102(c). Any change in design, materials, or other features may affect a firearm’s classification or have different implications under the GCA or NFA. In addition, a manufacturer’s or maker’s stated intent regarding a particular submission, while considered by ATF in its evaluation of a weapon, is not dispositive if the objective design features do not support that stated intent.<sup>17</sup>

<sup>16</sup> For instance, ATF regulations explain with respect to classifications of frames or receivers that “the Director may consider any associated templates, jigs, molds, equipment, tools, instructions, guides, or marketing materials that are sold, distributed, or possessed with the item or kit, or otherwise made available by the seller or distributor of the item or kit to the purchaser or recipient of the item or kit.” 27 CFR 478.12(c).

<sup>17</sup> *See Sig Sauer, Inc. v. Brandon*, 826 F.3d 598, 601 (1st Cir. 2016) (noting that, in the firearms classification context, it is appropriate for ATF to consider “a part’s design features . . . as part of the

### B. “Stabilizing Brace” Device-Related Classifications

Since 2012, ATF has analyzed how numerous “brace” devices affect a weapon’s classification under the NFA and has also classified numerous firearms equipped with a “stabilizing brace” for industry, the public, and in criminal cases. Results of the classifications were mixed, but ATF classified the majority of these submissions as NFA firearms. On November 8, 2012, an FFL submitted the first forearm “stabilizing brace” to ATF asking if the addition of their prototype device to a heavy pistol, such as an AR-type pistol, would change that type of pistol’s classification under Federal firearms laws.<sup>18</sup> The submitter described the “brace” device as designed to assist people with disabilities or limited strength or mobility with firing heavy pistols safely and comfortably, as these weapons can be “difficult to control with the one [-] handed precision stance.” The requester included the prototype pictures below.

#### BILLING CODE 4410-FY-P

inquiry into” the intended use of that part). The court noted that “[s]uch an objective approach to ferreting out a party’s intent is a very familiar one in the law. *See, e.g., United States v. Siciliano*, 578 F.3d 61, 77 (1st Cir. 2009) (noting that objective evidence is useful to ‘buttress or rebut direct testimony as to intent’); *cf. Washington v. Davis*, 426 U.S. 229, 253, 96 S. Ct. 2040, 48 L. Ed. 2d 597 (1976) (Stevens, J., concurring) (‘Frequently the most probative evidence of intent will be objective evidence of what actually happened rather than evidence describing the subjective state of mind of the actor.’); *United States v. Gaw*, 817 F.3d 1 (1st Cir. 2016) (‘[T]he law is long since settled that the prosecution may prove its case without direct evidence of a defendant’s guilty knowledge so long as the array of circumstantial evidence possesses sufficient persuasive power.’ (quoting *United States v. O’Brien*, 14 F.3d 703, 706 (1st Cir. 1994))).” *Id.* at 601–02.

<sup>18</sup> Letter for John Spencer, Chief, Firearms Technology Branch, ATF, from Alex Bosco, NST Global (Nov. 8, 2012).



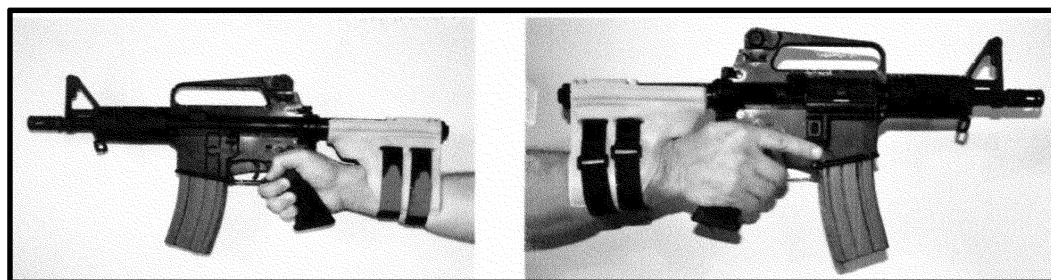
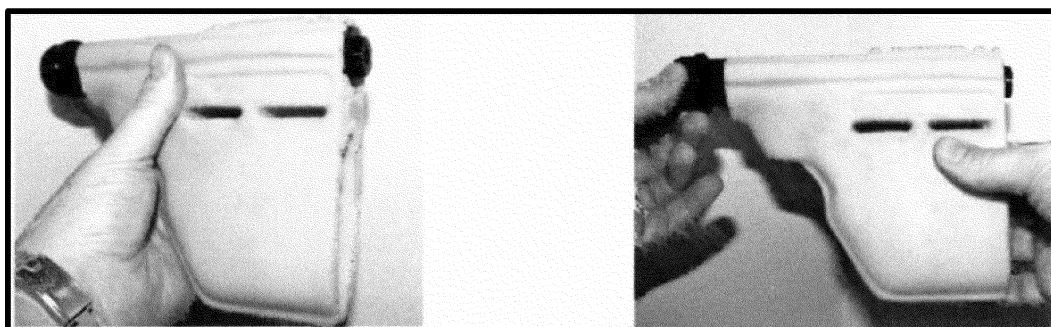
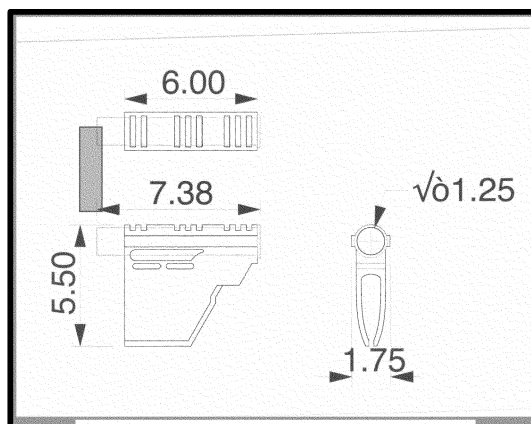

2012 submission of original “stabilizing brace” attached to an AR-type pistol

Based on the information provided, ATF’s FATD (then the Firearms Technology Branch) inspected the “brace” device and found that the particular sample was not “designed or intended to fire a weapon from the shoulder.”<sup>19</sup> FATD also concluded that, because the submitted “stabilizing brace,” when attached to a firearm, did

not convert that weapon to be fired from the shoulder, the attachment of the submitted “stabilizing brace” would not alter the classification of a pistol or other firearm.<sup>20</sup> This conclusion indicated that an AR-type pistol with the attached “stabilizing brace” would not be subject to the provisions of the NFA. Later, Sig Sauer marketed a

firearm equipped with a variation of the original “stabilizing brace” device, the SB15, which is pictured below.<sup>21</sup> The SB15 “brace” device is a product of the original brace manufacturer that was modified from the original “stabilizing brace” submitted to ATF for classification, discussed above.<sup>22</sup>

<sup>19</sup> Letter from ATF #2013-0172 (Nov. 26, 2012).

<sup>20</sup> The FATD classification used the term “convert.” This is consistent with the legal inquiry of whether a firearm is “redesigned” to be fired from the shoulder. See 18 U.S.C. 921(a)(7); 26 U.S.C. 5845(c).

<sup>21</sup> These firearms with an attached SB15 “stabilizing brace” were manufactured and sold by Sig Sauer. See Sig Sauer, *Pistols* (July 1, 2014), <https://web.archive.org/web/20140701212719/http://sigsauer.com/CatalogProductDetails/pm400-11-fde-psb.aspx>.

<sup>22</sup> SB Tactical, *Pistol Stabilizing Brace* (Sept. 28, 2014), <https://web.archive.org/web/20140928204628/http://www.sb-tactical.com/>.



**SB15 “Brace” Device on AR-15 Style Firearm**

**BILLING CODE 4410-FY-C**

After this initial classification, ATF received additional inquiries specifically on whether the use of a “stabilizing brace” as a shoulder stock redesigns the firearm to be a short-barreled rifle under the NFA and GCA. In March 2014, ATF responded to an inquiry from an unlicensed person who asked if firing an AR-type pistol from the shoulder would cause the pistol to be reclassified as a short-barreled rifle subject to NFA controls.<sup>23</sup> In its response, FATD noted that it classifies firearms based on the “physical design characteristics,” and that, while functionality indicates the intended design, it is not the sole criterion for determining the classification of a weapon.<sup>24</sup> FATD advised that it does not classify weapons based on how a particular individual uses a weapon and that merely firing an AR-type pistol from the shoulder did not reclassify it as a short-barreled rifle.<sup>25</sup> FATD further mentioned that some “brace” designs, such as the Sig Stability Brace, had not been classified as a shoulder stock and that, therefore, using those “braces” improperly would not constitute a

design change or change the classification of the weapon.<sup>26</sup>

Also in 2014, an individual asked ATF to examine the SB15 “stabilizing brace” on a firearm commonly known as a “pistol grip firearm” with a smooth bore to verify that the firearm is not regulated under the NFA. On October 28, 2014, ATF concluded: (1) that a forward grip (an additional handgrip toward the front of the firearm in addition to the pistol grip) attached to a pistol redesigns the firearm to be fired with two hands and therefore the firearm is no longer a “handgun” or “pistol,” and (2) that it would be classified as “any other weapon” pursuant to 26 U.S.C. 5845(e) under the NFA if its overall length is less than 26 inches or if it is actually concealed on the person.<sup>27</sup> The overall length of the submitted firearm was 27–1/4 inches and therefore ATF determined that, as submitted, the firearm was subject to regulation under the GCA but was not an NFA firearm, “provided the SigTac SB15 pistol stabilizing brace is used as originally designed and NOT used as a shoulder stock.”<sup>28</sup> In essence, ATF’s

original analysis focused on whether the inclusion of the forward grip subjected the firearm to the NFA, but ATF did not consider how the classification would be affected if a “pistol grip firearm” without a forward grip were to incorporate a “stabilizing brace.” Nevertheless, the addition of a “stabilizing brace” to these types of firearms does not assist with one-handed firing but rather redesigns the firearm by providing surface area for firing from the shoulder. Therefore, these types of firearms would fall within the purview of the NFA as short-barreled shotguns. 26 U.S.C. 5845(d). Because these types of firearms were never designed to be fired from one hand, this rule, as described in the NPRM, does not apply to firearms commonly referred to as pistol grip shotguns.<sup>29</sup> 86 FR at 30828–29. The 2014 classification described above and any classification that provides that a pistol grip shotgun is not an NFA firearm is no longer valid or authoritative as of January 31, 2023, and the firearm should be resubmitted to FATD for evaluation.

<sup>23</sup> Letter from ATF #301737 (Mar. 5, 2014).

<sup>24</sup> *Id.*

<sup>25</sup> *Id.*

<sup>26</sup> This and other ATF classification letters before 2018 referred to whether a “brace” had been classified as a shoulder stock. However, the proper inquiry as to whether a weapon is a “rifle” under the NFA and the GCA is not whether a particular component or accessory of the weapon is a stock, but whether the firearm, as configured, is “designed

or redesigned, made or remade, and intended to be fired from the shoulder.” 26 U.S.C. 5845(c). As this rule explains, ATF later corrected the standard it was applying by considering whether firearms configured with a “stabilizing brace” were intended to be fired from the shoulder. The focus on classifying an item as a “stock” was one of the issues that led to inconsistencies in ATF’s classification of these firearms.

<sup>27</sup> Letter from ATF #302492 (Oct. 28, 2014).

<sup>28</sup> *Id.* (underlining omitted, capitalization in the original).

<sup>29</sup> FATD experts state that a “pistol grip shotgun” typically refers to a weapon with the following attributes: (1) overall length of over 26 inches; (2) 12-gauge, smooth-bore barrel under 18 inches; (3) utilizes a shotgun-type receiver that has never had a shoulder stock attached; and (4) fitted with a “bird’s head” grip in lieu of a shoulder stock.





**2014 submission of pistol grip firearm equipped with a “stabilizing brace” and forward grip**

After the SB15 classification, ATF received newly designed “stabilizing brace” devices from other companies. One company in 2014 submitted a “Pistol Overmold Kit” with a “foam padded stabilizer tube” intended to accommodate a Glock-type pistol and requested a classification of the firearm

to determine if it would be regulated under the NFA. The company likened its product to installing a receiver extension/buffer tube on an AR type pistol, a configuration that FATD had earlier decided was not a shoulder stock when installed on that type of firearm and did not result in a change of that

pistol’s classification. However, FATD concluded that the “foam padded stabilizer tube” served “no legitimate, functional purpose other than to extend additional contact surface rearward” on Glock-type pistols and therefore would result in the manufacture of a “short-barreled rifle.”<sup>30</sup>

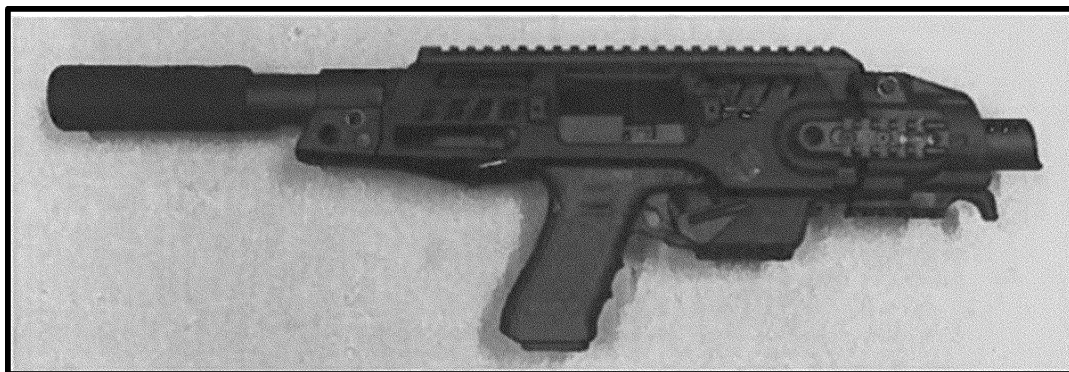

**2014 submission of Glock-type pistol with “foam padded stabilizer tube”**

In addition, FATD examined a “Pistol Overmold Kit” with an “adjustable stabilizer” also intended to incorporate a Glock-type pistol. FATD similarly concluded the “brace” device served no

purpose but to extend the rearward surface of the firearm and that the “brace” device is not required for the cycle of operations (*i.e.*, to expel a projectile by the action of an explosive)

of Glock-type pistols.<sup>31</sup> FATD therefore concluded the installation of the “adjustable stabilizer” would result in the manufacture of a short-barreled rifle regulated under the NFA.<sup>32</sup>

<sup>30</sup> Letter from ATF #302375 (Nov. 10, 2014).

<sup>31</sup> Letter from ATF #302531 (Nov. 13, 2014).

<sup>32</sup> *Id.*



**2014 submission of Glock-type pistol with “adjustable stabilizer”**

ATF continued to receive new designs of “stabilizing braces” from additional manufacturers. In September 2014, an FFL submitted a “Blade AR pistol stabilizer” device that incorporated a flexible stabilizing “fin” to rest against the inside of the shooter’s forearm when

in the firing position. According to the FFL, the “Blade AR pistol stabilizer” “stabilizes the firearm in the horizontal plane,” and “[t]he friction created between the user’s forearm and the fin then stabilizes the firearm in the vertical plane.”<sup>33</sup> They further stated that “a

user . . . can wrap a standard sling around the Blade AR and their forearm and secure it with the thumb of their firing hand to further stabilize their firearm in both the horizontal and vertical planes,” as shown below.<sup>34</sup>

**BILLING CODE 4410-FY-P**

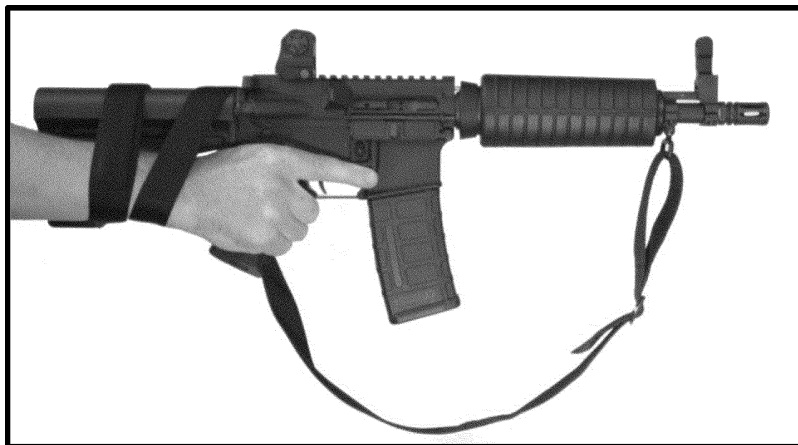

**“Blade AR Pistol Stabilizer” on AR-15**



**“Blade AR Pistol Stabilizer Accessory”<sup>35</sup>**

<sup>33</sup> Letter from ATF #302672 (Dec. 15, 2014).

<sup>34</sup> *Id.*

<sup>35</sup> As used in this rule, the term “accessory” is intended as a general term to describe the marketing of items commonly known as “stabilizing braces.”

Furthermore, use of that term in this rule does not affect any determinations whether such items are “defense articles” under the Arms Export Control Act (“AECA”). Please direct all inquiries as to possible liability for the firearms and ammunition

excise tax, 26 U.S.C. 4181–4182, to the Department of the Treasury, Alcohol and Tobacco Tax and Trade Bureau.



Like other submitters, the FFL asked if the addition of this device would convert a firearm in a manner that would cause it to be classified as a “rifle” and thus a “firearm” regulated under the NFA. In response, ATF stated “the submitted forearm brace, when attached to a pistol . . . is not a ‘firearm’ as defined by the NFA provided the Blade AR Pistol Stabilizer is used as originally designed [*i.e.*, for additional stabilizing support for single-handed firing] and NOT used as a shoulder stock.”<sup>36</sup>

Due to inconsistent advice regarding how the use of a “stabilizing brace” device affected a classification, and because FATD continued to receive

questions regarding whether a “brace” device could be used from the shoulder, ATF issued a 2015 Open Letter to the public regarding the classifications of firearms equipped with these “brace” devices under the NFA.<sup>37</sup> The 2015 Open Letter advised that “stabilizing braces” designed to assist shooters with single-handed firing were not considered a shoulder stock and could be attached to a handgun without making an NFA firearm. The 2015 Open Letter also provided that a person who “intends to use a handgun stabilizing brace as a shoulder stock on a pistol . . . having a rifled barrel under 16 inches” is making a firearm subject to

the NFA. The 2015 Open Letter further stated that “any person who *redesigns* a stabilizing brace for use as a shoulder stock makes a[n] NFA firearm when attached to a pistol with a rifled barrel under 16 inches in length or handgun with a smooth bore under 18 inches in length.”<sup>38</sup>

In 2015, an attorney representing the original developer of the “stabilizing brace” asked for a determination on whether the attachment of a retractable stabilizing brace to a handgun with a barrel under 16 inches constituted a firearm under the NFA. The requester provided the diagram below as part of the determination request.

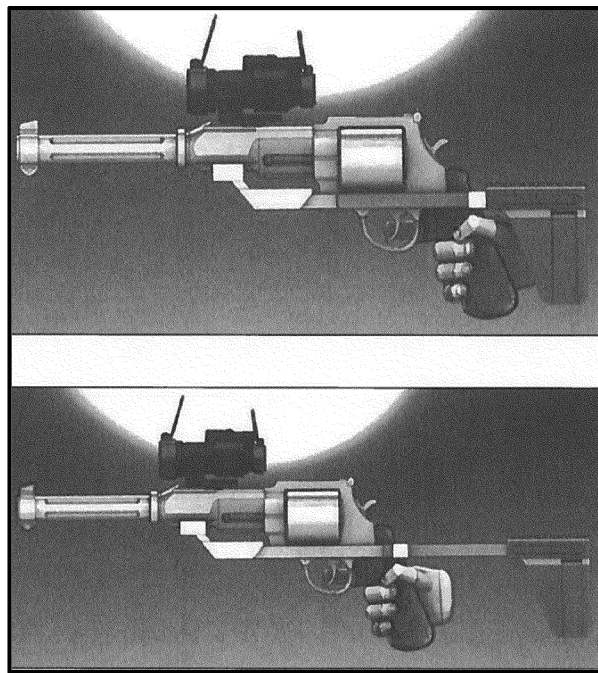

**2015 diagrams submitted of a “retractable pistol stabilizing brace” on a handgun**

On November 30, 2015, FATD responded by noting that prior devices “were not configurable to a position or setting in which the device more closely resembled a buttstock or shoulder stock in form and function.” FATD noted that this modified version was not similar to those prior other devices in which ATF found that the device did not convert the handgun to an NFA weapon.<sup>39</sup> FATD stated that “modifying the length of that part [of a ‘stabilizing brace’]

serves to extend a contact surface rearward of the pistol grip,” which is “a feature commonly associated with butt stocks/shoulder stocks” and shoulder-fired weapons. FATD advised that the “Retractable Pistol Stabilizing Brace” would likely be classified as a “device similar in form and function to a buttstock when installed on a firearm[,] thus reconfiguring the firearm” into a short-barreled rifle under the NFA. FATD further advised that the requester

would need to submit a physical sample in order for ATF to issue a formal classification.<sup>40</sup>

In 2015, the submitter of the original “stabilizing brace” device requested an evaluation of the physical device installed on a SIG MPX firearm that could be adjusted forward to accommodate smaller shooters for a more comfortable fit on the shooter’s forearm.

<sup>36</sup> Letter from ATF #302672 (Dec. 15, 2014) (emphasis omitted).

<sup>37</sup> See 2015 Open Letter, *supra* note 9.

<sup>38</sup> *Id.* (emphasis in the original).

<sup>39</sup> Letter from ATF #303984 (Nov. 30, 2015).

<sup>40</sup> *Id.*



**2015 submission of “adjustable stabilizing brace”**

In its evaluation, FATD noted that the raised ridges on the rear of the submitted sample “serve no functional purpose in the design of a pistol brace;

however, the ridges [on the back] do provide a non-slip, gripping surface, a feature commonly associated with buttstocks/shoulder stocks as well as

firearms designed and intended to be fired from the shoulder.”<sup>41</sup>



**Ridges on rear of the “adjustable stabilizing brace”**

FATD determined that this would not be a “short-barreled rifle,” provided the “brace” device is used as originally designed, not used as a shoulder stock, and the raised ridges are removed from the rear of the device. FATD’s classification relied on the

manufacturer’s continued representation that the design of the “brace” was to assist disabled shooters when firing heavy pistols with one-hand—indeed, the stated intent was “[c]entral” to ATF’s conclusion.<sup>42</sup>

On January 21, 2016, FATD classified a Smith and Wesson M&P pistol equipped with a “universal pistol brace,” which was marketed so that shooters can use the “brace” either above or below the forearm for support and recoil mitigation.<sup>43</sup>



**2016 submission of the “universal pistol brace” on a Smith and Wesson M&P pistol**

<sup>41</sup> Letter from ATF #304296 (Dec. 22, 2015).

<sup>42</sup> *Id.*

<sup>43</sup> Letter from ATF #303907 (Jan. 21, 2016).



FATD found the “universal pistol brace” device useful to reduce recoil of the host weapon (a Smith and Wesson M&P pistol) when the shooter places the foam piece of the brace on top of the shooter’s forearm.<sup>44</sup> However, FATD determined that the device, when assembled in an alternate configuration, incorporated buttstock design features, and that a firearm with the “brace” device installed in the alternate configuration depicted above had a length of pull of  $14\frac{1}{16}$  inches. This letter defined length of pull as the

“measurement found on shoulder[-]fired weapons, generally measured from the center of the trigger to the center of the buttplate/buttstock.”<sup>45</sup> FATD reasoned that the length of pull of shoulder-fired weapons is approximately  $13\frac{1}{2}$  to  $14\frac{1}{2}$  inches. After finding that this configuration resulted in an overall length of approximately  $18\frac{1}{2}$  inches and a barrel length of approximately  $4\frac{1}{4}$  inches, FATD classified this firearm as a short-barreled rifle under the NFA. The manufacturer subsequently redesigned the “universal pistol brace”

device and resubmitted it to ATF. The second submission of the device in the alternate configuration now incorporated a length of pull of  $12\frac{1}{8}$  inches, as depicted below. This evaluation also found that the foam portion of the “forearm brace” did not provide a surface area found on a shoulder stock assembly when attached to a pistol. FATD concluded that the device, when attached to a pistol-type firearm, did not design or redesign the host weapon to be fired from the shoulder.<sup>46</sup>



**2016 resubmission of “universal pistol brace” in an alternate configuration**

In 2016, another “brace” design reviewed by FATD was one that incorporated a folding clamp intended to provide support to the firing hand

and designed to be attached to an AR-type buffer tube or similar receiver extension. This type of device is referred to as a counterbalance type

“stabilizing brace” as discussed in section IV.B.3.b.viii of this preamble.

<sup>44</sup> *Id.*

<sup>45</sup> *Id.*

<sup>46</sup> Letter from ATF #304484 (June 7, 2016).



**Rear of the Folding Counterbalance Type Device**

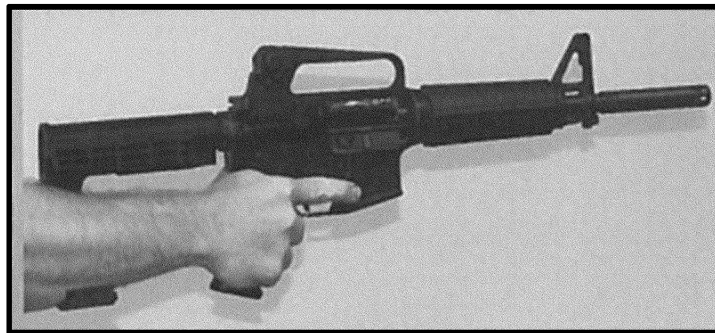

**Folding Counterbalance Type Device Assembled on an AR-Type Firearm**

FATD found that this device, when assembled on an AR-type firearm, allows the shooter to extend the clamp so it is under the shooter's forearm while gripping the pistol grip for additional support. This "stabilizing brace" device did not design or redesign

the firearm to be fired from the shoulder, and thus was not a "short-barreled rifle" under the NFA and GCA. But ATF noted that, if the firearm is fired from the shoulder, then the shooter designs or redesigns the firearm to be a rifle.<sup>47</sup> Subsequently, the same company

added a retractability feature to the "stabilizing brace" that allowed it to extend toward the shooter.<sup>48</sup> On January 18, 2017, FATD determined that a pistol equipped with the adjustable feature would still not be subject to NFA controls.<sup>49</sup>

<sup>47</sup> Letter from ATF #304679 (Oct. 3, 2016).

<sup>48</sup> Although ATF had opined earlier that retractability was a feature commonly associated with shoulder stocks, *see* Letter from ATF #303984 (Nov. 30, 2015), ATF subsequently opined that a "stabilizing brace" could be adjustable, *see* Letter from ATF #304296 (Dec. 22, 2015).

<sup>49</sup> Letter from ATF # 304511 (Jan. 18, 2017). ATF also issued a clarifying letter to the same company on January 30, 2017, regarding length of pull. Specifically, FATD defined "length of pull" as "a measurement found on shoulder-fired weapons, generally measured from the center of the trigger to the center of the buttplate/buttstock." FATD

research determined the average length of pull for a shoulder-fired weapon is approximately 13- $\frac{1}{2}$ -14- $\frac{1}{2}$  inches and the installation of a stabilizing brace to a pistol resulting in a similar length of pull would be characteristic of a shoulder-fired weapon. Letter from ATF #304679A (Jan. 30, 2017).



**Counterbalance Type “Stabilizing Brace” on an AR-15 Type Receiver Collapsed**

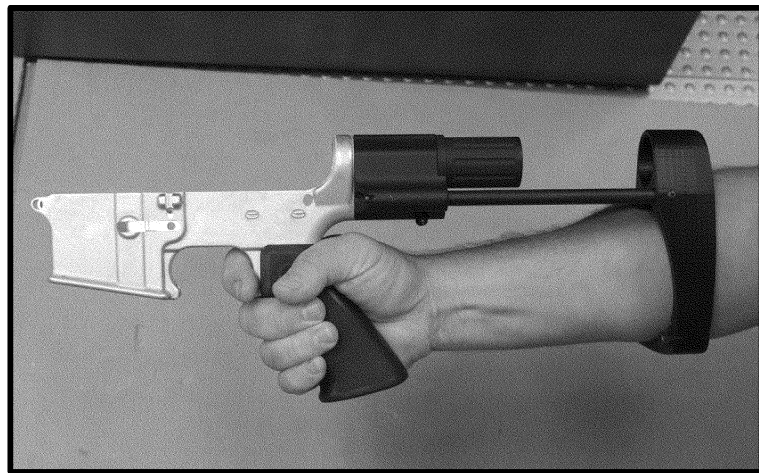

**Counterbalance Type “Stabilizing Brace” on an AR-15 Type Receiver Extended**

**BILLING CODE 4110-FY-C**

As discussed above in this preamble, ATF stated in prior letters and in the 2015 Open Letter that using a “stabilizing brace” device as a shoulder stock would redesign a pistol with a barrel less than 16 inches to a short-barreled rifle subject to the provisions of the NFA. On January 5, 2017, counsel to SB Tactical, LLC, submitted to ATF a request to reverse the 2015 Open Letter, arguing that determinations based on the use of a “stabilizing brace” device

created ambiguity because the way the item is used does not alter the design. On March 21, 2017, ATF responded by letter that: “Although we stand by those conclusions [of the 2015 Open Letter], we agree the Open Letter may have generated some confusion concerning the analytical framework by which those conclusions were reached.”<sup>50</sup>

<sup>50</sup> See Letter for Mark Barnes, Outside Counsel to SB Tactical, LLC, from Marvin G. Richardson, Assistant Director, Enforcement Programs and Services, ATF 90000:GM, 5000, *Re: Reversal of ATF*

ATF affirmatively concluded that incidental shouldering does not constitute a redesign of the firearm to be fired from the shoulder. The 2017 response letter also clarified:

*Open Letter on the Redesign of Stabilizing Braces* (Mar. 21, 2017) (italics omitted) (made widely available to the public on various websites, for example, <https://vpc.org/wp-content/uploads/2019/08/Pistol-brace-ATF-letter-March-21-2017.pdf> and <https://www.thefirearmblog.com/blog/2017/04/24/breaking-news-update-atf-reversal-letter-sb-tactical/>).



[When] the shooter/possessor takes affirmative steps to configure the device for use as a shoulder-stock—for example, configuring the brace so as to permanently affix it to the end of a buffer tube, (thereby creating a length that has no other purpose than to facilitate its use as a stock), removing the arm-strap, or otherwise undermining its ability to be used as a brace—and then in fact shoots the firearm from the shoulder using the accessory as a shoulder stock, that person has objectively “redesigned” the firearm for purposes of the NFA. This conclusion is not based upon the mere fact that the firearm was fired from the shoulder at some point. Therefore, an NFA firearm has not necessarily been made when the device is not re-configured for use as a shoulder stock—even if the attached firearm happens to be fired from the shoulder.<sup>51</sup>

After this letter, ATF reviewed the “Blade Pistol Stabilizer 2.0,” a new device redesigned after the first “Blade Pistol Stabilizer.” This new model included one attachment point for a strap or sling (as opposed to the first version’s three attachment points) and a metal carbine buffer tube adjustment lever that enabled the operator to move the blade into four positions along the buffer tube. FATD reviewed both the initial Blade stabilizer and the Blade Pistol Stabilizer 2.0 without the sling or strap. For this submission, FATD examined the “length of pull” of the firearm and determined the maximum length of pull on an AR-type receiver with the “Blade Pistol Stabilizer 2.0” attached is 13-<sup>3</sup>/<sub>16</sub> inches, which was just below the average length of pull for shoulder-fired weapons of 13-<sup>1</sup>/<sub>2</sub> to 14-

<sup>1</sup>/<sub>2</sub> inches. In a letter dated October 31, 2017, FATD concluded that the attachment of the “blade pistol stabilizer” to an AR-type firearm alone does not make an NFA weapon.<sup>52</sup> The letter noted that this classification letter applied only to the “Blade Pistol Stabilizer 2.0,” as submitted, and that any alternations to the device’s design could change this classification.<sup>53</sup>

By July 2018, FATD observed that SB Tactical had been marketing many of its “braces” as “ATF compliant” and with the following blanket statement: “The Bureau of Alcohol, Tobacco, Firearms and Explosives has stated that the SB Tactical™ Pistol Stabilizing Brace is ‘legal to own, legal to purchase and legal to install on a pistol.’ BATFE has consistently stated that a pistol with a Pistol Stabilizing Brace attached remains a pistol under the Gun Control Act when used as designed.”<sup>54</sup>

On July 18, 2018, FATD notified SB Tactical that it had only evaluated 2 out of approximately 20 of their manufactured “stabilizing brace” models and concluded that only 2 submitted samples had not been “designed or intended to be used as shouldering devices” such that attachment to a pistol did not convert that firearm to a short-barreled rifle. FATD also noted that any change in the submitted design could change its classification. Many of the other models sold by SB Tactical, which FATD had not evaluated, had been advertised as being based on shoulder stock designs.

ATF’s letter specifically stated that “FTISB does not approve ‘stabilizing braces’ which are similar or based off shoulder stock designs.”<sup>55</sup> The letter requested the manufacturer to cease false advertisement of products as “ATF approved,” as a majority of them had not been evaluated by ATF, much less “approved.”<sup>56</sup>

Moreover, toward the end of 2018, ATF recognized and informed requestors of classifications that, to effectively evaluate how an accessory affects the classification of a firearm under Federal law, FATD needed to examine the overall configuration of a firearm with the accessory (including purported “stabilizing brace”) installed. ATF informed requestors that, except in cases of conditional import determinations, it would not issue a determination on an accessory alone unless it was attached to the submitted firearm.<sup>57</sup>

On March 3, 2020, FATD examined two firearms, each equipped with a different “stabilizing brace” model (SBL Mini and SBA3), for one requestor.<sup>58</sup> The first firearm equipped with an SBL Mini “brace” device was determined to be a pistol based on all the objective design features, including the design of the attached brace that wrapped almost completely around the shooter’s forearm, the rear surface area of the device, and the firearm’s shorter length of pull when compared against typical AR-type shoulder-fired weapons.<sup>59</sup>



**2020 submission of firearm with SBL Mini attached**

<sup>51</sup> *Id.*

<sup>52</sup> Letter from ATF #307364 (Oct. 31, 2017).

<sup>53</sup> *Id.*

<sup>54</sup> SB Tactical, *Pistol Stabilizing Braces* (Dec. 30, 2018), <https://web.archive.org/web/20181230110445/https://www.sb-tactical.com/product-category/brace/>.

<sup>55</sup> Letter from ATF #308999 (July 18, 2018) (emphasis omitted).

<sup>56</sup> *Id.*

<sup>57</sup> *See, e.g.*, Letter from ATF #304547 (Dec. 17, 2018); Letter from ATF #304678 (Dec. 17, 2018); Letter from ATF #307644 (Dec. 17, 2018); Letter from ATF #308208 (Dec. 17, 2018); Letter from ATF #309044 (Dec. 17, 2018); Letter from ATF #309140

(Dec. 17, 2018); Letter from ATF #309515 (Dec. 17, 2018); Letter from ATF #309583 (Dec. 17, 2018); Letter from ATF #309742 (Dec. 17, 2018); Letter from ATF #309751 (Dec. 17, 2018); Letter from ATF #308318 (Dec. 17, 2018); Letter from ATF #309516 (Jan. 31, 2019); Letter from ATF #309807 (Feb. 1, 2019); Letter from ATF #304747 (Feb. 12, 2019); Letter from ATF #309861 (Feb. 12, 2019).

<sup>58</sup> Letter from ATF #311123 (Mar. 3, 2020); Letter from ATF #311127 (Mar. 3, 2020).

<sup>59</sup> Letter from ATF #311123 (Mar. 3, 2020). Both classifications provided:

This letter is not a final classification letter and does not constitute final agency action. However, it represents our current analysis based on the information we have, and we offer this letter for

your review in advance of issuing a final classification letter. If you have additional information you want to submit to ATF before it issues its final classification, you may send the information in writing within 10 days from the date of this letter. You may also, within the 10 day period, request an in-person meeting to present this additional information provided the meeting takes place within 10 days of the request. Please submit written comments or a request for an in-person meeting via email to [fire\\_tech@atf.gov](mailto:fire_tech@atf.gov). If additional information is received, it will be included in the analysis when the final classification is sent to you.

Letter from ATF #311123 (Mar. 3, 2020); Letter from ATF #311127 (Mar. 3, 2020).



The second firearm equipped with an SBA3 “brace” device was determined to be a short-barreled rifle. FATD reviewed all the objective design features of the submitted firearm, including the similarity of the SBA3 to known

shoulder stocks in form and function, the rear hardened surface area of the SBA3, the utilization of a standard AR-type Mil-Spec carbine receiver extension, and a “length of pull” useful for shouldering the firearm. FATD

concluded that all these factors “combine to provide objective design features consistent with weapons designed and intended to be fired from the shoulder.”<sup>60</sup>



**2020 submission of firearm with SBA3 attached**



**2020 submission of firearm with SBA3 attached in an extended position**

In June 2020, ATF classified another firearm equipped with a “proprietary Pistol Stabilizing Brace” that incorporated guide rails that are identical to the same rifle-type firearm the manufacturer sold as a short-barreled rifle (both of which are pictured below).<sup>61</sup> The guide rails permitted the adjustment of the “stabilizing brace” further rearward, the

attached “stabilizing brace” provided a larger rear surface area compared to the traditional stock on the company’s rifle-type firearm, and it had a length of pull of approximately 13-<sup>9</sup>/<sub>16</sub> inches. Further, the Velcro straps and flaps of the “brace” design had been reduced in size from the SB15 “stabilizing brace” and were not long enough to wrap around the shooter’s arm.<sup>62</sup> ATF’s classification

concluded that the objective design features of the accessory did not support the manufacturer’s stated intent, but instead supported the conclusion that the accessory had been designed and intended to be used as a shouldering device and, therefore, the firearm with the “brace” device attached is designed, made, and intended to be fired from the shoulder.<sup>63</sup>

<sup>60</sup> Letter from ATF #311127 (Mar. 3, 2020).

<sup>61</sup> Letter from ATF # 314200 (June 15, 2020).

<sup>62</sup> *Id.*

<sup>63</sup> *Id.*



**Pistol with attached “stabilizing brace” (top) compared to rifle (bottom), both marketed by the same company**

On June 16, 2020, seven members of the House of Representatives wrote to DOJ and ATF leaders expressing a “deep[ ] concern[ ]” about ATF’s “practice of relying on arbitrary, non-public standards to promulgate general firearms policy hidden from public scrutiny and awareness.”<sup>64</sup> The congressional letter asked specific questions regarding the criteria ATF uses to determine whether a firearm is designed and intended to be fired from the shoulder; specific publications available for Americans to determine whether their firearms are designed and intended to be fired from the shoulder; and how many firearms equipped with stabilizing braces FATD had examined.<sup>65</sup>

By late 2020, ATF concluded that: (1) previous ATF classification determinations had led to confusion and there was a need to provide clarity to the firearm industry and public on how ATF evaluates firearms equipped with a “stabilizing brace”; (2) manufacturers were adding to the confusion by labeling “stabilizing braces” that ATF had not evaluated as “ATF compliant”; and (3) as discussed in section IV.B.1.c of this preamble, these “braces” were being used with firearms extensively to create short-barreled rifles without following NFA requirements. As a

result, ATF first published a Notice in the **Federal Register** titled, “Objective Factors for Classifying Weapons with ‘Stabilizing Braces’” on December 18, 2020. 85 FR 82516. However, the Department withdrew the Notice on December 31, 2020. Objective Factors for Classifying Weapons With “Stabilizing Braces”; Withdrawal of Guidance, 85 FR 86948.

### III. Notice of Proposed Rulemaking

On June 10, 2021, the Department published in the **Federal Register** an NPRM titled, “Factoring Criteria for Firearms with Attached ‘Stabilizing Braces,’” proposing changes to the definition of “rifle” in 27 CFR 478.11 and 479.11 to clarify when a firearm with an attached “stabilizing brace” falls under the definition of “rifle.” 86 FR at 30826. The Department also proposed publishing the factors or criteria that ATF considers when it evaluates firearms equipped with a purported “stabilizing brace.” The factors discussed in the NPRM will, under the final rule, continue to help determine whether a weapon meets the statutory definition of a “rifle” or “short-barreled rifle” under the GCA and a “rifle” or “firearm,” *i.e.*, a short-barreled rifle, subject to regulation under the NFA. The NPRM included the factors on a new, proposed worksheet, “ATF Worksheet 4999,” that ATF proposed to rely on when making firearms classifications. That worksheet proposed assigning points to various criteria as an indicator of whether the “brace” device is suitable for shouldering and whether the firearm

overall is designed and intended to be fired from the shoulder. The comment period for the NPRM closed on September 8, 2021. *Id.* at 30826, 30828–29.

#### A. Definition of “Rifle”

The Department proposed amendments to clarify the definition of “rifle” by adding at the end of the current definition a sentence stating that the “term shall include any weapon with a rifled barrel equipped with an accessory or component purported to assist the shooter stabilize the weapon while shooting with one hand, commonly referred to as a ‘stabilizing brace,’ that has objective design features and characteristics that facilitate shoulder fire, as indicated on Factoring Criteria for Rifled Barrel Weapons with Accessories commonly referred to as ‘Stabilizing Braces,’ ATF Worksheet 4999.” *Id.* at 30851.

In the NPRM, the Department briefly discussed the history of the first forearm “brace” submitted to ATF in 2012, the purpose for which the “brace” was designed as described by the developer, and the inquiry to ATF on whether the addition of that “brace” device to a pistol, such as an AR–15 type pistol, would convert or alter the firearm’s classification to a “rifle,” and thus potentially a “firearm” under the NFA. *Id.* at 30827. As discussed in section II.B of this preamble, ATF concluded at the time that the addition of that prototype “stabilizing brace” device did not convert that weapon to be fired from the shoulder and that the weapon with the submitted “brace” device was not

<sup>64</sup> Letter for William Barr, Attorney General, and Regina Lombardo, Acting Director, ATF, from Matthew Gaetz, United States Representative, *et al.* (June 16, 2020), [https://gaetz.house.gov/sites/gaetz.house.gov/files/wysiwyg\\_uploaded/For%20Web%206-16-2020%20DOJ-ATF%20pistol%20brace%20letter%20final.pdf](https://gaetz.house.gov/sites/gaetz.house.gov/files/wysiwyg_uploaded/For%20Web%206-16-2020%20DOJ-ATF%20pistol%20brace%20letter%20final.pdf).

<sup>65</sup> *Id.*



“designed and intended to be fired from the shoulder.”

The NPRM made clear that, after the addition of an accessory or component that is marketed as a “stabilizing brace” to a pistol, the resulting braced firearm may still be classified as a pistol. Classifying a firearm based on a limited or single factor (e.g., the marketing label of the manufacturer that the item is a “stabilizing brace”) “has the potential to be significantly overinclusive or underinclusive.”<sup>66</sup> The NPRM explained the importance of properly classifying firearms subject to the NFA, given that short-barreled rifles are among the firearms considered “unusual and dangerous,” and that firearms with “stabilizing braces” have been used in at least two mass shootings, with the shooters in both instances reportedly using the “brace” as a shoulder stock.<sup>67</sup> These incidents demonstrated the deadly efficacy of attaching certain types of “braces” to pistols to create short-barreled rifles. 86 FR at 30828.

The NPRM explained that, although ATF generally does not classify unregulated components or accessories alone under the GCA and NFA,<sup>68</sup> there are times when the addition of a component or an accessory to a firearm can affect the firearm’s classification. This is because: (1) a component’s or an accessory’s likely use in the general community may be relevant in assessing whether the manufacturer’s or maker’s purported intent with respect to the design of a firearm is consistent with the manufacturer’s or maker’s actual intent;<sup>69</sup> and (2) the design of a

component or an accessory may cause a firearm to fall within a particular statutory definition when attached to the firearm.<sup>70</sup> A “stabilizing brace,” of which there are several variations, is one such component or an accessory that may change the classification of the firearm to which it is attached. *Id.*

The Department reiterated in the NPRM that it has been ATF’s longstanding and public position that a firearm does not evade classification under the NFA merely because the firearm is configured with a device marketed as a “stabilizing brace.”<sup>71</sup> When a purported “stabilizing brace” and an attached weapon’s objective design features indicate that the firearm is actually designed and intended to be fired from the shoulder, such weapon may fall within the scope of the NFA as a short-barreled rifle, thus requiring registration and payment of tax. As described in section II.B of this preamble, ATF has evaluated on a case-by-case basis several models of “stabilizing braces” and has considered whether a particular firearm configured with a “stabilizing brace” has the objective features of a firearm designed and intended to be fired from the shoulder, thus subjecting it to the requirements of the NFA and GCA. The use of a “stabilizing brace” cannot be a tool to circumvent the NFA and GCA and the prohibition on the unregistered possession of short-barreled rifles.

In the NPRM, the Department explained that the objective design features of a firearm are relevant to determining whether the NFA’s requirements apply, given that the purpose of the NFA is “to regulate certain weapons likely to be used for criminal purposes.” *United States v. Thompson/Center Arms Co.*, 504 U.S. 505, 517 (1992); *see also id.* (“It is of course clear from the face of the Act that the NFA’s object was to regulate certain weapons likely to be used for criminal purposes, just as the regulation of short-barreled rifles, for example, addresses a concealable weapon likely to be so

used.”). This is the case even when a manufacturer characterizes or markets a firearm accessory in a manner that suggests a use that does not correspond to its objective design. The characterization of an accessory by the manufacturer, including assertions in advertising, may be relevant, but is not dispositive. ATF considers the objective design features, the manufacturer’s or maker’s intent as reflected in marketing materials, and other information demonstrating likely use of the firearm in the general community in deciding whether the weapon is designed and intended to be fired from the shoulder. Where ATF’s evaluation of a submitted sample demonstrates that the objective design features of the firearm, as configured, do not support the manufacturer’s purported intent and, in fact, suggest a different intent, then ATF may conclude that the firearm ought not be classified on the basis of the manufacturer’s purported intent, thus ensuring effective enforcement of Federal law. *See Sig Sauer, Inc. v. Brandon*, 826 F.3d 598, 601–02 (1st Cir. 2016) (objective design features could supersede a manufacturer’s “assert[ion]” about the “intended use,” as a different conclusion would allow easy circumvention of the NFA); *see also* 86 FR at 30828.

The Department also explained that, with the increase in production of rifled-barrel weapons with “stabilizing braces,” ATF saw an increase in the requests for classifications of this kind of firearm design. As described above, ATF issued several letters examining “brace” devices and also particular firearms equipped with “stabilizing braces” for industry and in criminal cases. In its recent determinations, FATD discussed various objective features that are considered when evaluating whether a firearm that is equipped with a “stabilizing brace” is designed and intended to be fired from the shoulder. Recognizing the criticism from various parties that ATF had not widely published a definitive approach in the application of that criteria, the NPRM proposed a worksheet listing the criteria or factors that FATD considers when evaluating firearm samples that are submitted with an attached “stabilizing brace” or similar component or accessory. The worksheet, titled “Factoring Criteria for Rifled Barrel Weapons with Accessories commonly referred to as ‘Stabilizing Braces,’ ATF Worksheet 4999,” was proposed to allow individuals or members of the firearms industry to evaluate whether a weapon incorporating a “stabilizing brace” that

<sup>66</sup> *Innovator Enters., Inc. v. Jones*, 28 F. Supp. 3d 14, 25 (D.D.C. 2014).

<sup>67</sup> *See, e.g., Cameron Knight, Dayton Shooter Used a Modified Gun that May have Exploited a Legal Loophole*, USA Today (published Aug. 5, 2019, updated Aug. 6, 2019), <https://www.usatoday.com/story/news/nation/2019/08/05/dayton-shooter-used-gun-may-have-exploited-legal-loophole/1927566001/> (the firearm used in a shooting killing 9 people and wounding 14 had a “pistol brace” used to “skirt[]” regulation of short-barrel rifles); Melissa Macaya *et al.*, *10 Killed in Colorado Grocery Store Shooting*, CNN (updated Mar. 23, 2021), [https://www.cnn.com/us/live-news/boulder-colorado-shooting-3-23-21/h\\_0c662370eeff05eac3ef8d5f29e94](https://www.cnn.com/us/live-news/boulder-colorado-shooting-3-23-21/h_0c662370eeff05eac3ef8d5f29e94) (reporting that the firearm used in a shooting that killed 10 was an AR-15 pistol with an “arm brace”).

<sup>68</sup> ATF does, however, make these types of classifications under the AECA, 22 U.S.C. 2778, with respect to the permanent importation of “defense articles.” Additionally, ATF provides classifications of barrels or ammunition as non-sporting for importability purposes under the GCA under 18 U.S.C. 922(l) and 925(d). The origin of certain firearms parts and accessories listed under 27 CFR 478.39 may also be considered by ATF in the enforcement of 18 U.S.C. 922(l).

<sup>69</sup> *Cf. Posters ‘N’ Things v. United States*, 511 U.S. 513, 521–22 (1994) (Whether an item is “primarily intended” for a specified use is an objective

analysis that must focus on the “likely use” of that item in the general community, rather than the subjective intent of a particular person.)

<sup>70</sup> The NPRM provided examples of where attachment of an accessory can affect a firearm’s classification. These included: the attachment of a forward secondary grip to a “pistol” where the resulting firearm would no longer be designed to be held and fired with a single hand, *see United States v. Black*, 739 F.3d 931, 934–36 (6th Cir. 2014); and a wallet holster where the handgun can be fired while inserted, thus changing the classification of these handguns into an “any other weapon” under 26 U.S.C. 5845(e), *see FFL Newsletter* 5–6 (Aug. 1997), <https://www.atf.gov/firearms/docs/newsletter/federal-firearms-licensees-newsletter-%E2%80%93-august-1997/download>.

<sup>71</sup> 86 FR at 30828 & n.13.

they intended to submit to FATD or to offer for sale would be considered a “short-barreled rifle” subject to NFA requirements. The worksheet assigned points to various criteria, as further described below.

The NPRM explained that the proposed criteria and worksheet did not apply to firearms commonly referred to as “pistol grip shotguns,” as they were never designed to be held and fired using one hand (*e.g.*, Mossberg Shockwave, Remington Tac-14).<sup>72</sup> See also 86 FR at 30828–29.

As discussed in section II.B of this preamble, these firearms are specifically designed to be fired with two hands. ATF has always classified these weapons as “firearms” under the GCA, and not as “shotguns,” because they do not incorporate a shoulder stock and are not designed and intended to be fired from the shoulder like a shotgun. Nor has ATF classified these weapons as “pistols,” as they are not designed to be held and fired in one hand like a pistol. Thus, the addition of a “stabilizing brace” does not assist with single-handed firing, but instead provides surface area that allows for firing from the shoulder. Therefore, a “pistol grip shotgun” equipped with a “stabilizing brace” and a barrel of less than 18 inches is an NFA “firearm,” *i.e.*, a short-barreled shotgun.<sup>73</sup>

#### B. Application of Proposed ATF Worksheet 4999

Similar to the Factoring Criteria for Weapons, ATF Form 4590 (“Form 4590”), which is used for the importation of pistols and revolvers, the proposed ATF Worksheet 4999 contained a point system assigning a weighted value to various characteristics of the fully assembled firearm, as configured when submitted for classification. Under the proposed worksheet, a firearm accumulating fewer than 4 points in Section II (Accessory Characteristics), and fewer than 4 points in Section III (Configuration of Weapon), would have been generally determined not to be designed to be fired from the shoulder, unless there was evidence that the manufacturer or maker expressly intended to design the weapon to be fired from the shoulder. A firearm accumulating 4 points or more in Section II or Section III would have indicated that not only is the “brace” device more suitable as a shoulder stock

but also that the firearm’s overall configuration with the “brace” attached was designed, made, and intended to be fired from the shoulder. See 86 FR at 30828–30.

The NPRM explained why certain prerequisites (*i.e.*, weapon weight and overall length) would be considered first to determine if the host firearm would be a suitable weapon for a “stabilizing brace.” The Department believed that these prerequisites would help ATF to determine if the host firearm could be immediately identified as a rifle, as defined by the applicable statutes. Moreover, as discussed, “stabilizing braces” were originally marketed as intended to assist persons with disabilities and others lacking sufficient grip strength to control heavy pistols. ATF had found the attachment of a “stabilizing brace” to a standard pistol that is light enough to hold with no additional assistance to be impractical and hence also to be a likely preliminary indicator that the attachment changes the firearm into a firearm designed and intended to be fired from the shoulder. Similarly, the attachment of a “stabilizing brace” to a firearm that is so heavy or difficult to control that the firearm cannot feasibly be held with one hand would also indicate the firearm is a rifle. For these types of heavy pistols, ATF reasoned that the purported “stabilizing brace” would have no design function other than to facilitate the firing of the weapon from the shoulder. *Id.* at 30829.

The proposed Worksheet 4999 assigned point values for the objective design characteristics or features that are common to rifles, features associated with shoulder stocks, and features limiting the ability to use the “stabilizing brace” as an actual “brace.” These point values ranged from 0 to 4 points based upon the degree of the indicator, explained as follows:

- 1 point: Minor Indicator (the weapon could be fired from the shoulder)
- 2 points: Moderate Indicator (the weapon may be designed and intended to be fired from the shoulder)
- 3 points: Strong Indicator (the weapon is likely designed and intended to be fired from the shoulder)
- 4 points: Decisive Indicator (the weapon is designed and intended to be fired from the shoulder)

The point values associated with particular features or designs were based upon their relative importance in classifying the firearm under Federal law. Therefore, more points were assigned to design features that more strongly indicated the manufacturer or

maker’s intent was to produce a shoulder-fired weapon.

The various factors on the Worksheet 4999 fell into two categories—Accessory Characteristics and Configuration of the Weapon. The NPRM explained the criteria that would be considered and why they were important in making classifications of firearms with attached “stabilizing braces.” *Id.* at 30831–34. As stated above, if the total point value of the firearm submitted was equal to or greater than 4—in either Section II (Accessory Characteristics) or III (Configuration of a Weapon)—then the firearm, with the attached “stabilizing brace,” would be determined to be “designed or redesigned, made or remade, and intended to be fired from the shoulder,” or a “rifle” under the GCA and NFA. And, if the attached barrel was also less than 16 inches, the firearm would be classified as a “short-barreled rifle” under the GCA and come under the NFA definition of “firearm.”

Section IV of the NPRM provided examples of how the factoring criteria in Worksheet 4999 would be implemented with respect to three weapons with common “stabilizing braces” attached. *Id.* at 30834–43. Under these examples, the NPRM showed that, in applying the factors of the worksheet: (1) an AR-Type Firearm with SB-Mini Accessory would be classified as a pistol with an attached “stabilizing brace” because it garnered three points in each of Section II and III; (2) an AR-Type Firearm with SBA3 Accessory would be classified as a “short-barreled rifle” subject to the NFA because it garnered eight points in Section II and five points in Section III; and (3) an AR-Type Firearm with Shockwave Blade Accessory as configured would also be classified as a short-barreled rifle subject to the NFA because it garnered five points in Section II and 14 points in Section III.

In the NPRM, the Department also noted that ATF issued classifications to some makers or manufacturers without having had the benefit of evaluating the “brace” when attached to a firearm. The NPRM encouraged any maker or manufacturer who received a classification prior to the effective date of the final rule to resubmit the weapon with the attached “stabilizing brace” to ensure that the classification is consistent with the rule and to avoid any possible criminal or tax penalties for the continued manufacture, transfer, or possession of a NFA firearm. 86 FR at 30829.

As described above, FATD’s classifications allow industry members to plan and develop products that comply with the law, thereby reducing their risk of incurring criminal or civil

<sup>72</sup> See section II.B of this preamble for discussion on “pistol grip shotgun” classification letter.

<sup>73</sup> As mentioned above, any classification that provides that a “pistol grip shotgun” is not an NFA firearm is no longer valid or authoritative and should be resubmitted to FATD for evaluation.

penalties or the need for corrective actions, including a recall by the manufacturer. The Department recognized that the proposed clarification of the relevant statutory terms in the NFA and GCA with respect to weapons with an attached “stabilizing brace” device might have practical effects on industry members and members of the public, as they might make or manufacture, or already own, firearms with a “stabilizing brace” attached. To assist affected persons and industry members, section V of the NPRM provided additional information in the preamble to aid them in complying with Federal laws and regulations. *Id.* at 30843–44.

#### IV. Analysis of Comments and Department Responses

In response to the NPRM, ATF received over 237,000 comments. Submissions came from individuals, lawyers, government officials, and various interest groups. Of the comments reviewed, nearly 20,000 comments expressed support for the proposed rule, of which just under 18,000 were submitted by individuals as form letters, *i.e.*, identical text that is often supplied by organizations or found online and recommended to be submitted to the agency as a comment. There were over 217,000 comments opposed to aspects of the rule. Approximately 96,000 comments were submitted as form letters and, of these, just over 25,000 were submitted using the National Association for Gun Rights (“NAGR”) form letter. The commenters’ grounds for support and opposition, along with specific concerns and suggestions, are discussed below.

##### A. Comments Received in Support

Many commenters generally supported the rule. These commenters explained that while “stabilizing braces” were originally developed to assist those with physical disabilities shoot a firearm, pistol braces are frequently used to effectively turn firearms into short-barreled rifles, making the firearms subject to registration requirements under the NFA.

Numerous commenters argued that the adoption of this rule would promote public safety. Other commenters indicated that they favored greater regulation of firearms in general. One commenter, a retired military servicemember with familiarity with firearms, stated that if the weapon does not fit in a holster at the waist or shoulder, or can be hidden in a pocket, then it is not a handgun. Another commenter similarly agreed and said “I

love the 2A! Love my guns! Never give them up! That being said, if you put it to your shoulder it’s a rifle!”

Below, the Department sets forth and responds to the specific issues raised in comments that generally supported the NPRM.

##### 1. Closes a Loophole and Prevents Circumventing the Law

###### Comments Received

Numerous commenters stressed that this rule would help close the “Arm Brace Loophole,” pointing out that while “braces” may be useful in certain instances, problems arise when they are made to function as a buttstock. For instance, commenters agreed with ATF that there are individuals who are trying to circumvent the law by calling a collapsible stock a “brace” when in reality the “braces” are being used as buttstocks. Commenters stated that these types of firearms are an “attempt by many to create a short-barreled rifle under the guise of assisting shooters with disabilities.” Another commenter stated that he has never understood selling “pistols” with attached “stabilizing braces” because “it was just a way to skirt the legislation already in place for short-barreled rifles.” One commenter, who identified as a former gunsmith and licensee with experience in the firearms industry for over 15 years, stated that he has “never seen anyone utilize a brace in the manner that it was originally designed.” The commenter also stated that he has “often found that the vast majority of ‘brace’ designs cannot be actually used as intended.” The commenter pointed out several types of weapons with braces, such as the CZ Evo Scorpion pistol, which are “clearly [weapons] designed to be fired from the shoulder.” The commenter strongly urged that all these weapons should be reclassified as NFA weapons, which is how he believes they should have been initially designated.

Numerous commenters opined that firearms companies are simply trying to circumvent the law through the use of “braces.” One commenter stated that “while arm braces have enabled disabled shooters to operate large-format pistols with one hand, the gun industry has sidestepped this intended use to market pistols equipped with arm braces as an alternative to ‘short-barreled rifles.’” Another commenter, a long-time shooting enthusiast, similarly opined that “[t]his whole thing has been a marketing tool to sell firearms to people that do not have enough knowledge to make informed purchasing decision.”

Some commenters stated that this rule is long overdue. The commenters believed it is not hard for individuals to complete the NFA paperwork to register their short-barreled rifles and that it is not a significant cost on gun owners. One commenter indicated that gun owners who spend \$1500 on an AR pistol should be able to afford the \$200 tax to register it.

###### Department Response

The Department acknowledges the commenters’ support of the proposed rule. The definitions of “rifle” under the GCA and NFA include a weapon designed or redesigned, made or remade, and intended to be fired from the shoulder. 18 U.S.C. 921(a)(7), 26 U.S.C. 5845(c). The GCA and NFA do not ban or regulate “stabilizing brace” devices that are not attached to a firearm, and this rule does not have that effect, nor does it ban weapons equipped with a purported “stabilizing brace.” The Department agrees that while some “stabilizing brace” devices may assist an individual with disabilities, or limited mobility or strength, in stabilizing a large and heavy pistol, many purported “stabilizing braces,” when attached to a weapon, result in a firearm with objective design features indicating the “braced” weapon is designed, made, and intended to be fired from the shoulder. Accordingly, they may appropriately be classified as a rifle and possibly a short-barreled rifle, depending on barrel length. As a result, the Department agrees with the commenters above that a weapon attached with a purported “stabilizing brace” may fall within the purview of the NFA and, if so, must satisfy statutory requirements.

This rule amends the definition of “rifle” to clarify that the term “designed or redesigned, made or remade, and intended to be fired from the shoulder” includes a weapon that is equipped with an accessory, component, or other rearward attachment (*e.g.*, a “stabilizing brace”) that provides surface area that allows the weapon to be fired from the shoulder, provided other factors, as listed in the amended regulations, indicate that the weapon is designed, made, and intended to be fired from the shoulder. These other factors are: (1) whether the weapon has a weight or length consistent with the weight or length of similarly designed rifles; (2) whether the weapon has a length of pull, measured from the center of the trigger to the center of the shoulder stock or other rearward accessory, component, or attachment (including an adjustable or telescoping attachment with the ability to lock into various



positions along a buffer tube, receiver extension, or other attachment method), that is consistent with similarly designed rifles; (3) whether the weapon is equipped with sights or a scope with eye relief that require the weapon to be fired from the shoulder in order to be used as designed; (4) whether the surface area that allows the weapon to be fired from the shoulder is created by a buffer tube, receiver extension, or any other accessory, component, or other rearward attachment that is necessary for the cycle of operations; (5) the manufacturer's direct and indirect marketing and promotional materials indicating the intended use of the weapon; and (6) information demonstrating the likely use of the weapon in the general community.

For the reasons discussed in section IV.B of this preamble, the Department incorporated the relevant objective design features (as described in §§ 478.11(2)(i)–(iv) and 479.11(2)(i)–(iv) of the final regulatory text) directly from the NPRM and proposed Worksheet 4999. In addition, as explained below, the Department has incorporated the factors described in §§ 478.11(2)(v)–(vi) and 479.11(2)(v)–(vi). Although the factors in these paragraphs are not objective design features of the weapon, the NPRM observed that evidence other than objective design features would sometimes play a role in classifying a weapon. For example, the NPRM stated that certain weapons, based on their point totals on the proposed worksheet, would not be classified as rifles “unless there [was] evidence that the manufacturer or maker expressly intended to design the weapon to be fired from the shoulder.” 86 FR at 30829. The Department believes that the final rule should likewise account for the possibility that factors other than objective design features may affect a weapon's classification, and the final rule accordingly includes §§ 478.11(2)(v)–(vi) and 479.11(2)(v)–(vi).

The Department also agrees with commenters that the procedure to register short-barreled rifles, which include in certain instances firearms with “stabilizing braces,” is through an ATF Form 1, Application to Make and Register a Firearm (“Form 1”), with the approval of the Attorney General, or, for SOT holders, an ATF Form 2, Notice of Firearms Manufactured or Imported (“Form 2”). See 26 U.S.C. 5822; 27 CFR 479.62, 479.68. Usually, each maker submitting a Form 1 must pay a \$200 making tax on each NFA firearm

made.<sup>74</sup> See 26 U.S.C. 5821. As described in sections IV.B.8.e, IV.B.9.b–c, and V.C of this preamble, however, the Department will exercise its enforcement discretion not to enforce the making tax on any individual or entity for weapons affected by this rule that are currently in the possession of the individual or entity, provided the individual or entity registers the firearm by May 31, 2023. See 26 U.S.C. 7805(b) (1994) (granting discretion to determine retroactive effect of regulations relating to the internal revenue laws). Individuals and FFLs without an SOT would submit an electronic version of Form 1 (“E-Form 1”) for the affected short-barreled rifles with an attached “stabilizing brace” in their possession as of the date this rule is published. Type 7 FFLs with an SOT, in contrast, would submit an electronic version of Form 2 (“E-Form 2”) for the affected short-barreled rifles with an attached “stabilizing brace” in their inventory as of the date this rule is published.

Provided the registration form is properly submitted and documented within the defined time period, the Department will consider individuals and entities to be in compliance with the statutory requirements between the date on which a person's application is filed and the date a person receives ATF approval or disapproval of the application. After the 120-day registration period following the publication of this rule, registration of previously made or manufactured weapons with “stabilizing braces” that constitute NFA firearms will not be permitted. Any person in possession of a short-barreled rifle for which an E-Form 1 or E-Form 2 has not been submitted to ATF within the defined time period will be in violation of the NFA, and ATF may take enforcement action. Individuals or entities that do not wish to register their firearms may refer to section V.B of this preamble for other options.

## 2. Enhances Public Safety Comments Received

Comments submitted by the attorneys representing the cities of Boulder, Colorado, and Dayton, Ohio, noted that short-barreled rifles are uniquely dangerous because they “combine the power of shoulder-mounted rifles with the concealability of handguns” and that “stabilizing braces” are functionally equivalent to shoulder stocks. The commenters observed that “the Dayton

<sup>74</sup> Submission of a Form 2, in contrast, does not require an accompanying tax payment. Thus, for weapons registered on a Form 2, there is no tax payment for ATF to forgo collecting.

and Boulder shooters' pistol braces allowed them to better hide their weapons and better deploy them to attack dozens of innocent victims.” This rule, the commenters argued, “would be a positive step in helping cities like Boulder and Dayton protect their citizens . . . from devastating attacks” from firearms with an attached “stabilizing brace.”

Numerous commenters likewise opined that dangerous people have manipulated the use of “stabilizing braces” on pistols to create assault-style pistols that make the firearm more dangerous because it can be easier to conceal, and to shoot more bullets faster. They argued that the rise of these weapons and the ease in which they can be acquired greatly impacts public safety.

Similarly, other commenters, including former law enforcement officers, voiced support for the rule and reclassification of weapons with an attached “stabilizing brace” as NFA firearms because they are effectively short-barreled rifles, which, as evidenced by their use in the Boulder and Dayton mass shootings, “are unusually dangerous because they can be easily concealed like a handgun but have the firepower and accuracy of a rifle.” Commenters agreed this rule change was a good measure because “[m]ore and more often these braces are showing up on crime gun and it is alarming.”

Several commenters approved of the fact that the rule addresses the threat to public safety “while still allowing for disabled shooters to utilize arm braces.” One commenter stated that “[e]nacting this rule will continue to enable disabled shooters to purchase and use these devices, but will better protect the American public from gun violence.”

## Department Response

The Department acknowledges the commenters' support and agrees this rule will benefit public safety. Short-barreled rifles have been recognized by Congress and the courts as the type of uniquely dangerous weapons appropriately regulated under the NFA. Courts have recognized the dangerousness and uniqueness of NFA firearms, and that the possession of unregistered NFA firearms poses a danger to the community. See *United States v. Jennings*, 195 F.3d 795, 799 (5th Cir. 1999) (Congress determined that the unregistered possession of the particular firearms regulated under the NFA should be outlawed because of “the virtual inevitability that such possession will result in violence.”); *United States v. Cox*, 906 F.3d 1170,

1184 (10th Cir. 2018) (explaining the Supreme Court's conclusion that "the historical tradition of prohibiting the carrying of dangerous and unusual weapons" supported limiting the Second Amendment's protection to weapons 'in common use at the time' of ratification" (quoting *District of Columbia v. Heller*, 554 U.S. 570, 626–27 (2008)); *United States v. Gonzalez*, No. 2:10-cr-00967, 2011 WL 5288727, at \*5 (D. Utah Nov. 2, 2011) ("Congress specifically found that 'short-barreled rifles are primarily weapons of war and have no appropriate sporting use or use for personal protection.'" (quoting S. Rep. No. 90–1501, at 28 (1968))).

Short-barreled rifles specifically are dangerous and unusual due to both their concealability and their heightened ability to cause damage—a function of the projectile design, caliber, and propellant powder used in the ammunition and the ability to shoulder the firearm for better accuracy. See *United States v. Marzarella*, 614 F.3d 85, 90–95 (3d Cir. 2010) (explaining that a long gun with a shortened barrel is both dangerous and unusual because "its concealability fosters its use in illicit activity," and "because of its heightened capability to cause damage"), *abrogated on other grounds as stated in Frein v. Pennsylvania State Police*, 47 F.4th 247, 253 (3d Cir. 2022); *United States v. Amos*, 501 F.3d 524, 531 (6th Cir. 2007) (McKeague, J., dissenting) ("[A] sawed-off shotgun can be concealed under a large shirt or coat . . . [T]he combination of low, somewhat indiscriminate accuracy, large destructive power, and the ability to conceal . . . makes a sawed-off shotgun useful for only violence against another person, rather than, for example, against sport game."); *Bezot v. United States*, 276 F. Supp. 3d 576, 611–12 (E.D. La. 2017) ("Prior to the enactment of the NFA, Congress recognized that the country struggled to control the violence wrought by 'gangsters, racketeers, and professional criminals.' . . . Similarly to the GCA, the NFA was adopted by Congress to establish a nationwide system to regulate the sale, transfer, license, and manufacturing of certain 'dangerous weapons' such as 'machine guns, sawed-off shotguns, sawed-off rifles, and other firearms, other than pistols and revolvers, which may be concealed on the persons, and silencers.' . . . [T]he NFA targets 'certain weapons likely to be used for criminal purposes.'" (footnotes omitted.)), *aff'd*, 714 F. App'x 336 (5th Cir. 2017). Many firearms with "stabilizing braces" include a barrel of less than 16 inches

and the objective design features of a firearm designed and intended to be fired from the shoulder. These types of firearms are those that Congress sought to regulate, as confirmed by Federal courts.

The Department also acknowledges that firearms equipped with "stabilizing braces" have been used in two mass shootings, with shooters in both instances reportedly shouldering the "brace" as a shoulder stock, demonstrating the weapons' efficacy as "short-barreled rifles."<sup>75</sup> The compact size of these firearms also assists with concealability of a firearm with a large destructive power. Since 2014, the FTCB reports that there have been approximately 104 Federal criminal classifications where firearms equipped with a "stabilizing brace" have been received by FATD for classification as a part of criminal investigations. Further, since 2015, ATF reports that approximately 63 firearms with "stabilizing braces" have been traced in criminal investigations.<sup>76</sup> ATF has approximately 105 firearms cases or investigations involving "stabilizing brace" devices.<sup>77</sup>

#### B. Comments Received in Opposition

A majority of commenters opposed the proposed rule or any new regulation or registration requirements for firearms equipped with an attached "stabilizing brace." Commenters broadly argued that ATF should not make any changes from previous determinations regarding "stabilizing braces," thus allowing owners of such attachments to continue using these items in their current configurations. As discussed below, many of the commenters that opposed the rule raised various concerns about the Department's proposed amendments to ATF regulations and the factors in the proposed Worksheet 4999. Commenters raised constitutional and statutory authority concerns and also concerns with denying persons with disabilities the use of a "stabilizing brace" to assist with shooting a firearm. They further argued that the rule punishes law-abiding citizens and does not advance

the Department's public safety goals. Commenters also questioned ATF's initial analysis regarding the costs of the rulemaking.

#### 1. Statutory Concerns

##### a. Lack of Statutory Authority To Issue a Rule on "Stabilizing Braces"

###### Comments Received

Numerous commenters asserted that ATF is overstepping its authority and changing the scope of the law on its own. Commenters also stated that ATF is in the executive branch and not the legislative branch, and therefore it should not be creating new laws, which is allegedly what the proposed rule achieves. A few other commenters stated that while DOJ has some leeway in making recommendations to Congress, only Congress has the authority to make changes to the law.

Commenters further asserted that ATF has no statutory authority to regulate or impose NFA controls on accessories such as secondary grips, sights and scopes, or peripheral accessories, including "stabilizing braces." Another commenter argued that ATF's proposed criteria are "in support of a non-statutory analysis about whether a weapon can be more easily fired with one hand or two hands" and that this is inconsistent with the NFA and GCA's obligation that the agency regulate weapon that are "intended to be fired from the shoulder." For example, the commenter argued that several factors of Section III of proposed Worksheet 4999 violated the statute because they allowed ATF to assign points based on the presence of certain "peripheral accessories" or "bipod/monopod accessories"; these accessories, according to the commenter, are not considered suitable for shouldering, and their inclusion on Worksheet 4999 was contrary to the plain text of the statute.

Commenters asserted that not only is ATF beyond the scope of its authority under the GCA in issuing this rule but also that ATF has limited authority to promulgate regulations that are necessary to enforce the provisions of the GCA and NFA. These commenters believed the change proposed by this rule "has the power of a Federal law that the American public did not get to vote on." Further, commenters argued that "ATF is without authority to amend, supplement, reinterpret or rewrite the laws that Congress enacts, even to implement what the *agency perceives* to have been Congress' intent when passing the law. Rather it is ATF's responsibility to implement the law *as it is written*." (Emphases in the original.) At least one commenter noted that if the

<sup>75</sup> See *supra* note 67.

<sup>76</sup> This information is drawn from the Firearms Tracing System (FTS) database maintained by ATF's National Tracing Center's (NTC) covering January 1, 2015, through November 1, 2022. The number of traced firearms equipped with a "stabilizing brace" device may be underreported because this information is captured in FTS when the user entering the firearm information makes observations and enters relevant terms like "brace" or "stabilizing brace" in the "Additional Markings" field of FTS.

<sup>77</sup> This information is from ATF's Office of Strategic Intelligence (OSI) covering January 1, 2015, through November 1, 2022.



intent of Congress is clear, the agency must not interpret the law in a way other than the original intent of Congress and that ATF cannot “simply add to the clear unambiguous definition of ‘rifle’ provided by Congress.”

#### Department Response

The Department does not agree that the rule exceeds the authority provided under law; the rule is interpreting the language of the statute as written. Moreover, as explained in section II.A of this preamble, the Attorney General is responsible for enforcing the GCA and NFA, and Congress provided authority to the Attorney General to promulgate regulations as are necessary to enforce the provisions of these laws. See 18 U.S.C. 926(a); 26 U.S.C. 7801(a)(2)(A), 7805(a). Congress and the Attorney General have delegated the responsibility for administering and enforcing the GCA and NFA to the Director of ATF, subject to the direction of the Attorney General and the Deputy Attorney General. See 26 U.S.C. 7801(a)(2); 28 U.S.C. 599A(b)(1), (c)(1); 28 CFR 0.130(a)(1)–(2); T.D. Order No. 221(2)(a), (d), 37 FR at 11696–97. Accordingly, the Department and ATF have promulgated regulations to implement the GCA and NFA. See 27 CFR parts 478, 479. “Because [section] 926 authorizes the [Attorney General] to promulgate those regulations which are ‘necessary,’ it almost inevitably confers some measure of discretion to determine what regulations are in fact ‘necessary.’” *Nat’l Rifle Ass’n v. Brady*, 914 F.2d 475, 479 (4th Cir. 1990). Like reasoning applies to 26 U.S.C. 7805(a), which states in similar language that “[the Attorney General] shall prescribe all needful rules and regulations for the enforcement of this title.” And courts have long recognized that regulatory agencies do not establish rules to last forever. “They are neither required nor supposed to regulate the present and the future within the inflexible limits of yesterday.” *Am. Trucking Ass’n v. Atchison, Topeka, and Santa Fe Ry. Co.*, 387 U.S. 397, 416 (1967).

In the original GCA implementing regulations, ATF provided regulatory definitions for terms that Congress did not define in the statute. Internal Revenue Service, Department of the Treasury, 33 FR 18555 (Dec. 14, 1968) (e.g., “business premises”, “curios or relics”, “frame or receiver”, “state of residence”). Since 1968, ATF has occasionally added definitions to the implementing regulations. See, e.g., Implementation of Public Law 104208, Omnibus Consolidated Appropriations Act of 1997 (96R–034P), 63 FR 35520 (June 30, 1998) (implementing

definition of “misdemeanor crime of domestic violence” and terminology used in the statutory definition that was undefined such as “a person who is cohabiting with or has cohabited with the victim as a spouse”). As is the case with the GCA, ATF has provided regulatory definitions for terms in the NFA that Congress did not define, such as “manual reloading,” “responsible person,” “single function of the trigger,” “automatically,” and “frame or receiver.” See Miscellaneous Amendments, 26 FR 2407 (Mar. 22, 1961) (defining “manual reloading”); Machineguns, Destructive Devices and Certain Other Firearms; Background Checks for Responsible Persons of a Trust or Legal Entity With Respect To Making or Transferring a Firearm, 81 FR 2658 (Jan. 15, 2016) (adding the definition for the term “responsible person”); Bump-Stock-Type Devices, 83 FR 66514 (Dec. 26, 2018) (defining the terms “single function of the trigger” and “automatically”); Definition of “Frame or Receiver” and Identification of Firearms, 87 FR 24652 (Apr. 26, 2022) (revising and clarifying the definition of “frame or receiver”). These definitions were necessary to implement the statutes.

This rule is similar to these other examples, and, contrary to commenters’ suggestions, it is not creating a new law; instead, it simply clarifies the definition of “rifle” under 27 CFR 478.11 and 479.11, as necessary to implement existing law—*i.e.*, the NFA and GCA. Although Congress defined the term “rifle” in the NFA, see 26 U.S.C. 5845, Congress did not further define the key phrase from that definition: “designed or redesigned, made or remade, and intended to be fired from the shoulder.” Given the wide variety of configurations of weapons and “stabilizing braces,” this rule is “necessary” or “needful” to clarify the meaning of this phrase. See 18 U.S.C. 926; 26 U.S.C. 7805(a). This rule supplies that necessary clarity by providing the objective design features and other factors that ATF will use to discern whether a firearm is designed, made, and intended to be shoulder fired, and this rule represents the Department’s best interpretation of the relevant statutory language.

If a pistol with an attached “stabilizing brace” is found to be a “rifle,” then such firearm could also be considered a “short-barreled rifle” under the NFA and GCA, depending on the overall length of the weapon or length of the attached barrel, thus subjecting it to additional requirements as an NFA weapon. 26 U.S.C. 5845(a)(3)–(4); 18 U.S.C. 921(a)(8); *cf.* *Thompson/Center Arms Co.*, 504 U.S. at

513 n.6 (“The inclusion of the rifle stock in the package brings the Contender [pistol] and carbine kit within the ‘intended to be fired from the shoulder’ language contained in the definition of rifle in the statute. See 26 U.S.C. 5845(c). The only question is whether this combination of parts constitutes a short-barreled rifle.”).<sup>78</sup> A firearm does not evade classification as an NFA weapon simply because it is configured with a compatible attachment, such as a “stabilizing brace,” that may serve a function other than as a shoulder stock to effectuate shoulder fire. As described in section II.B of this preamble, ATF recognized at the end of 2018 that it was necessary to evaluate the actual firearm at issue with the “brace” device attached.<sup>79</sup>

This rule makes clear that the configuration of a pistol with an attached “stabilizing brace” can possess objective design features that, along with the direct or indirect marketing materials from the manufacturer or other information showing likely use by the general community, demonstrate the firearm is configured to be fired from the shoulder, making it a “rifle.” Section IV.B.3 of this preamble discusses further the factors necessary to determine when a weapon is a rifle as defined by the NFA and GCA. By incorporating the objective design features and other factors into the amended regulatory definition of “rifle,” the Department is implementing the statutory definition of “rifle” so the industry and public receive notice and may avoid potential legal hazards when installing a “brace” or other device on a firearm. Contrary to commenters’

<sup>78</sup> The Supreme Court in *Thompson/Center* concluded that the “mere possibility” that a pistol and accompanying kit might be “use[d] to assemble a regulated firearm” did not establish that the “combined packaging” of the kit and pistol brought the package within the scope of “making” a short-barreled rifle. 504 U.S. at 513. The Department is not adopting such an approach. This rule does not require regulation of a pistol based on the “mere possibility” that a “stabilizing brace” may be attached and the resulting firearm fired from the shoulder. Rather, the rule requires a consideration of objective design features and other factors to determine whether the “braced” weapon is designed, made, and intended to be fired from the shoulder.

<sup>79</sup> See *supra* note 57 and accompanying discussion. Additionally, on April 26, 2022, the Department published the final rule titled “Definition of ‘Frame or Receiver’ and Identification of Firearms,” in which ATF codified in its regulations at 27 CFR 478.92(c) instructions to the public that any requests for a determination on how an item affects the classification of a firearm under the GCA or NFA must include the firearm sample with all accessories and attachments relevant to the classification. 87 FR at 24743. Prior to the publication of that final rule, FATD had been conveying this information through the classification process.

assertions, the Department is not regulating the manufacture, sale, or possession of “stabilizing braces” themselves—that is, “stabilizing braces” when not attached to or associated with particular weapons. Accordingly, the rule does not create any new law; instead it simply implements the relevant statutes based on the Department’s best interpretation of those statutes.

#### b. Lack of Authority Regarding Tax Collection

##### Comments Received

One commenter argued that ATF “is claiming authority to reclassify [pistols] that it doesn’t have.” (Emphasis omitted). In particular, the commenter asserted that the proposed rule violates 26 U.S.C. 4181–4182, 5811, which impose a 10 percent tax on pistols and a \$200 tax on short-barreled rifles, all monies that have already been collected. Because ATF is not “grandfather[ing] current pistols,” the commenter asserted that “ATF would have to undo that tax, because something cannot be a Pistol and [a short-barreled rifle].” The commenter argued that ATF would have to go back a decade to collect taxes due on short-barreled rifles and that the agency “has no authority to undo that tax” because, according to the commenter, only Congress can change the tax code and only for that calendar year. (Emphasis omitted).

##### Department Response

The Department disagrees with the commenter who argued that the proposed rule violates 26 U.S.C. 4181–4182, 5811, which impose excise and making taxes on pistols and short-barreled rifles. As discussed above, the Attorney General delegated the administration and enforcement of the NFA to the Director of ATF. The Internal Revenue Code (“IRC”), 26 U.S.C. 6201, provides the Secretary of the Treasury with the legal authority to determine and assess the amount of taxes owed by a taxpayer. Section 7801(a)(2)(A) of the IRC grants this same authority to the Attorney General with respect to enforcing the provisions of the NFA (*i.e.*, chapter 53 of title 26). This section states in relevant part that “[t]he administration and enforcement of [as relevant here, chapter 53 of title 26] shall be performed by or under the supervision of the Attorney General; and the term ‘Secretary’ or ‘Secretary of the Treasury’ shall, when applied to those provisions mean the Attorney General.” Therefore, ATF has authority consistent with the IRC to classify

firearms and assess the appropriate tax liability of the manufacture, making, or transfer of the item under the NFA.

The Department also disagrees with the commenter’s argument that the Department is “chang[ing]” the tax code. The Department acknowledges that firearms equipped with “stabilizing brace” devices that are designed or redesigned, made or remade, and intended to be fired from shoulder, *i.e.*, “rifles”, or “firearms (other than pistols or revolvers)” incur an 11 percent excise tax, and that pistols and revolvers incur a 10 percent excise tax when the firearm is sold by a large manufacturer<sup>80</sup> to a purchaser. 26 U.S.C. 4181, 4182; 27 CFR 53.2. Manufacturers who sold 50 or more such rifles in a calendar year and did not pay tax under 26 U.S.C. 5811 (the NFA transfer tax) may be required to pay that excise tax in accordance with Federal regulations under Chapter 32 of the IRC. However, any determination that a particular weapon is a “rifle” within the meaning of the tax code does not change the tax code itself. It simply classifies an item for purposes of the tax code. Moreover, the Department notes that excise taxes are administered and collected by the Alcohol and Tobacco Tax and Trade Bureau, which is a part of the Department of the Treasury.

#### c. Administrative Procedure Act (“APA”)

##### i. APA—Change in ATF Position

##### Comments Received

Numerous commenters asserted that the proposed rule is another “flip flop” by the agency and arbitrary and capricious in violation of the APA. Commenters said that ATF has long held the position that the NFA does not apply to pistols equipped with “stabilizing braces,” even if the “braces” are used to secure the weapons to the shoulder. Numerous commenters outlined the history and positions ATF has taken with respect to pistols with attached “stabilizing braces,” claiming

<sup>80</sup> For purposes of excise tax, the term “Manufacturer,” as defined in 27 CFR 53.11, includes any person who produces a taxable article from junk material or from new or raw material by processing, manipulating, or changing the form of an article or by combining or assembling two or more articles. The term also includes a “producer” and an “importer.” The person for whom the taxable article is manufactured or produced, and not the person who actually manufactures or produces it, will be considered the manufacturer where a person manufactures or produces a taxable article for another person who furnishes materials under an agreement whereby the person who furnished the materials retains title thereto and to the finished article.

that ATF has been very inconsistent in its approach. For example, one commenter questioned why ATF first officially recognized that a “stabilizing braces” configured on an AR–15 style pistol did not create a “rifle,” but then, starting in 2012, provided 10 letters going back and forth on whether a “stabilizing brace” attached to a firearm did create a “rifle.” Specifically, multiple commenters noted that, in 2020, ATF said that “stabilizing braces” do not turn an AR-pistol into a short-barreled rifle. Commenters stated that now, after numerous years, ATF’s proposed rule would make all previously produced combinations of “braces” and firearms rifles rather than pistols.

Another commenter believed that ATF arbitrarily changed its interpretation because it stated in the NPRM that “stabilizing braces” are marketed “to support single-handed firing.” 86 FR at 30827. Because of this statement in the NPRM, the same commenter remarked that “ATF apparently believes that a stabilizing brace can *never* be used on a ‘firearm’ that is designed to be operated by two hands.” (Emphasis in the original.) The commenter argued that a “stabilizing brace” can be used to support two-handed, non-shouldered fire.

##### Department Response

The Department acknowledges that the variations of “stabilizing brace” designs, the manufacturer’s purported intent for “brace” devices, the changes in ATF’s classification process, and the inconsistencies in ATF’s analysis of “braces” attached to firearms may have led to confusion regarding the application of the NFA and GCA to firearms equipped with a purported “stabilizing brace.”

The Department agrees with commenters, including SB Tactical, that the analyses in some of ATF’s prior opinions regarding incidental firing from the shoulder and the use of “stabilizing brace” devices on firearms have been inconsistent. Furthermore, as discussed below, ATF acknowledges that its classifications issued between 2012 and 2020 did not properly or consistently evaluate whether firearms equipped with those devices were “rifles” as defined in the NFA and GCA. Specifically, ATF’s analysis placed improper weight on whether the “stabilizing brace” at issue could be used as a “brace” to support single-handed fire rather than whether the overall configuration of the firearm with

the attached “brace” is designed and intended to be fired from the shoulder, as required by the statutory definition of the term “rifle.”

Nevertheless, the Department disagrees that any prior inconsistencies or changes by ATF make this rule arbitrary and capricious under the APA. Despite inconsistencies in ATF’s prior classifications, each classification letter referenced ATF’s practice of considering the physical design characteristics or features when looking at a “stabilizing brace” device on a firearm.<sup>81</sup> The Department acknowledges that this rule is a change in position from some of ATF’s previous classifications or positions, but the intent of this rule is to resolve prior inconsistencies and ensure consistent application of the statutory definition of “rifle” to firearms equipped with “stabilizing braces” or other rearward attachments. As discussed below, the prevalent shouldering of these firearms further demonstrates that a majority of firearms equipped with “stabilizing braces,” currently or previously available on the market, incorporate rifle characteristics. Therefore, it is necessary for the Department to issue this rule to clarify the statutory definition of “rifle” and to inform the public of the best interpretation of the definition, which will guide the proper legal and factual analysis to be conducted in evaluating whether a firearm is designed, made, and intended to be fired from the shoulder. As a result, and to ensure consistency moving forward, ATF’s prior classifications pertaining to “stabilizing brace” devices, or firearms equipped with a “stabilizing brace,” are no longer valid or authoritative as of May 31, 2023.<sup>82</sup>

When an agency changes course, the agency must “provide [a] reasoned explanation for its action.” *F.C.C. v. Fox*

<sup>81</sup> For example, a 2014 letter provided that “FTB classifies weapons based on their physical design characteristics.” Letter from ATF #301737 (Mar. 5, 2014). In the 2015 Open Letter, ATF noted that it had previously looked at the objective design features in classifying a “stabilizing brace,” even as it also considered the manufacturer’s or makers’ stated intent. Similarly, in a 2017 letter to counsel for SB Tactical, ATF clarified that if a shooter takes “affirmative steps to configure the device for use as a shoulder stock—for example, configuring the brace so as to permanently affix it to the end of a buffer tube, (thereby creating a length that has no other purpose than to facilitate its use as a stock), removing the arm-strap, or otherwise undermining its ability to be used as a brace—and then in fact shoots the firearm from the shoulder using the accessory as a shoulder stock, that person has objectively ‘redesigned’ the firearm for purposes of the NFA.” Letter from ATF #30736 (Oct 31, 2017).

<sup>82</sup> The Department has similarly announced in a different final rule that certain classifications of frames or receivers were no longer authoritative. See 87 FR at 24741.

*Television Stations, Inc.*, 556 U.S. 502, 515 (2009). The agency, however, has no heightened burden in prescribing regulations that displace inconsistent previous regulatory actions. *Id.* at 514–15. Federal courts recognize that it is within ATF’s discretion to reclassify and rectify a firearms classification error provided the agency’s interpretation is consistent with the statute and legislative history. *Akins v. United States*, 312 Fed. App’x 197, 200 (11th Cir. 2009) (holding the reclassification of the Akins Accelerator as a machinegun was not arbitrary and capricious).<sup>83</sup> Accordingly, the Department recognizes it is within ATF’s authority to replace its prior inconsistent legal classifications, provided the change is reasonably explained and the new position is permissible under the statute.

From 2012 to 2018, ATF issued several classifications of “stabilizing braces” concluding that the “brace” did not redesign a firearm to be fired from the shoulder.<sup>84</sup> These pre-2018

<sup>83</sup> See also *Guedes v. Bureau of Alcohol, Tobacco, Firearms, and Explosives*, 356 F. Supp. 3d 109, 127 (D.D.C. 2019), judgment entered, 762 F. App’x 7 (D.C. Cir. 2019) (“So long as any change is reasonably explained, it is not arbitrary and capricious for an agency to change its mind in light of experience, or in the face of new or additional evidence, or further analysis or other factors indicating [an] earlier decision should be altered or abandoned.” (alteration omitted) (quoting *New England Power Generators Ass’n v. FERC*, 879 F.3d 1192, 1201 (D.C. Cir. 2018)); *Aposhian v. Barr*, 374 F. Supp. 3d 1145, 1153 (D. Utah 2019) (concluding that ATF’s change in policy with regard to bump stocks was permissible under the statute and was supported by good reasons when ATF explained that prior position was not based on substantial or consistent legal and where new interpretation was both permissible and best interpretation of the statute), *aff’d*, 958 F.3d 969 (10th Cir. 2020), *reh’g en banc granted, judgment vacated*, 973 F.3d 1151 (10th Cir. 2020), *vacated sub nom. Aposhian v. Wilkinson*, 989 F.3d 890 (10th Cir. 2021), and *opinion reinstated sub nom. Aposhian v. Wilkinson*, 989 F.3d 890 (10th Cir. 2021).

<sup>84</sup> ATF classified the following brace devices prior to August 2018:

- SB Tactical SB15 (marketed by SIG)
- SB Tactical PSB Brace
- Shockwave Blade Version 1
- Shockwave Blade Version 2
- Shockwave Blade with KAK Tube
- Gear Head Works Tailhook Version 1
- Gear Head Works Tail Hook Version 2
- Safe Pistol Arm Brace
- Strike Industries Stabilizer
- Three Versions of Strike Industries Stabilizers
- Strike Industries Stabilizer/Blade
- Trinity Force AR Pistol Stabilizer
- Bicep Brace Version 3
- Accu Pistol Brace Version 2
- Forearm BraceBP15 “AR15-type” Pistol
- Stabilizing Brace Version 2
- Minimal Arm Brace
- Buffer Tube Adaptor for AK w/SB15

Additionally, in 2020 ATF classified a Ruger 556 pistol with a SB Tactical SBL Mini “stabilizing brace attached as a pistol and not a rifle.

classifications looked at whether the “stabilizing brace” brought a firearm within the purview of the NFA in part by placing improper weight on the manufacturer’s stated intent to install the “brace” on heavy pistols (e.g., AR-type, AK-type, CZ Scorpion) to stabilize the arm to support single-handed fire, rather than whether objective design features and other evidence, as listed in this rule, indicated that the firearm equipped with the “brace” had been designed and intended to be fired from the shoulder. ATF’s classification letters after 2018, while appropriately focusing on objective design features, continued to place improper weight on whether the “stabilizing brace” at issue could be used as a “brace” to support single-handed fire, even if the overall configuration of the firearm equipped with the “brace” indicated the weapon was designed or redesigned, made or remade, and intended to be fired from the shoulder. In other words, ATF now concludes that it incorrectly reviewed and classified the weapons with purported “stabilizing braces” in those classifications, with an inappropriate reliance on the manufacturer’s assertions that a “stabilizing brace” was intended to assist with single-handed firing without regard to whether the objective features of the firearm indicate that it is designed and intended to be fired from the shoulder.<sup>85</sup> This resulted in inconsistencies in ATF classifications and an incorrect public perception that a firearm equipped with a “stabilizing brace” never falls within the purview of the NFA, regardless of the objective design features of the firearm. The Department accordingly clarifies for the public and the firearms industry that the term “designed or redesigned, made or remade, and intended to be fired from the shoulder” includes a weapon that is equipped with an accessory, component, or other rearward attachment (e.g., a “stabilizing brace”) that provides surface area that allows the weapon to be fired from the shoulder, provided that other factors, as listed in the final regulatory text, also indicate that the weapon with such surface area is designed, made, and intended to be fired from the shoulder.

The Department also acknowledges the commenters’ concerns that ATF changed its interpretation when it indicated in the NPRM that “a stabilizing brace can be used only to support single-handed firing.” Indeed, the Department agrees that the ability to fire with a single hand is not in part of the GCA or NFA definition of “rifle.” Hence, in prior classifications, ATF

<sup>85</sup> See *supra* note 26.



erroneously concluded that the incorporation of a “stabilizing brace” that allowed single-handed firing, as stated by the manufacturer, precludes the firearm from being designed, made, and intended to be fired from the shoulder. This interpretation by ATF incorrectly read into the GCA and NFA a requirement that, for a firearm to be a rifle, it must exclusively be designed, made, and intended to be fired from the shoulder; in other words, ATF did not recognize that a firearm equipped with an accessory or rearward attachment like a “stabilizing brace” may be a rifle, regardless of whether the firearm includes a feature that might permit an alternate use of one-handed firing. It is similarly incorrect to focus on whether a “stabilizing brace” can be used, in some circumstances, to support two-handed, non-shouldered fire.

Indeed, courts have likewise held that a firearm does not need to be designed and intended exclusively to be fired from the shoulder to constitute a short-barreled rifle under the law. *See United States v. Rose*, 695 F.2d 1356, 1358 (10th Cir. 1982) (holding that a firearm with a collapsible stock is a short-barreled rifle and rejecting the defendant’s claim that the weapon must have been designed or redesigned to fire exclusively from the shoulder). The Tenth Circuit stated that, “[a]lthough the Uzi could be fired from several positions, testimony indicated that the Uzi is an effective shoulder weapon,” and the Uzi’s “collapsible stock[] permitted [it] to be fired from the shoulder.” *Id.* The Uzi was accordingly “redesigned or intended to be used as a rifle within the meaning of” the statutory definition. *Id.* Similarly, in a case involving a firearm with a 14–1/2 inch barrel that could be fired with one hand or from the shoulder, a defendant argued that, because the firearm lacked any sights and because it was not necessarily advantageous to fire the weapon from the shoulder, the firearm should not be regulated as a “rifle” under the NFA. *Sipes v. United States*, 321 F.2d 174, 178–79 (8th Cir. 1963),

*overruled on other grounds.*<sup>86</sup> The Eighth Circuit concluded the weapon was still a rifle. *Id.* “That it had no sights or that it could be fired elsewhere than from the shoulder makes it no less a rifle within the statutory definition.” *Id.* at 178. This reasoning is plainly applicable here. A “stabilizing brace” device cannot remove a firearm from the definition of a rifle solely because the purported purpose or effect of the device is to facilitate one-handed firing, even if the device does allow one-handed firing as a possible alternative means of using the weapon.

Due to the past inconsistencies and misapplication of the statutory definition as pointed out by commenters, the Department is within its statutory authority and under an obligation to reconsider and rectify its past classifications. Moreover, the fact that many of these “stabilizing brace” devices are designed and intended to be the equivalent of a shoulder stock, or that firearms equipped with “stabilizing brace” devices are in fact designed and intended to be fired from the shoulder, is abundantly evident in publications and consumer and marketing material issued by firearms manufacturers. For instance, ATF identified multiple online articles after its evaluation of SB Tactical’s SB15 that cited the SB15 “brace” as a method to circumvent the NFA, in that the “brace” functions well as a shoulder stock. The articles also included pictures of individuals shooting firearms, equipped with the SB15, from the shoulder.<sup>87</sup> ATF

identified one article posted on SB Tactical’s website, dated December 23, 2014, which discussed an award for SB Tactical’s CEO as the most influential personality of the year for inventing the SB15. The article states: “It’s no secret that Bosco’s brace can also be used as a shoulder stock by people with two good arms. With Bosco’s brace, all Americans are able to modify an AR–15-style pistol into what’s effectively [a short-barreled rifle]—without additional ATF infringement on their gun rights.”<sup>88</sup>

SB Tactical has posted articles that explained how short-barreled rifle performance could be obtained from a pistol equipped with a “stabilizing brace.”<sup>89</sup> In 2016, SB Tactical also presented a YouTube video advertisement describing shooting techniques for a pistol attached with their “brace” device.<sup>90</sup> As shown below, the video included demonstrations of multiple “stabilizing brace” models that ATF had not evaluated.

**BILLING CODE 4410-FY-P**

*category/Sig+Sauer* (“So basically if you have an AR Pistol and you install this arm brace, it lets you legally own something that is similar to an SBR in handling/shouldering terms, without filling a Form 4, paying for a tax stamp, and waiting between 8–12 months for your stamp and approved paperwork, AND not being able to transport the firearm between states without notification of [law enforcement officers].”); Dave Higginbotham, *Sig Sauer P556, Short Barrel Rifle Performance from a Pistol—New Gun Review*, Gun America Digest (May 30, 2014), <https://www.gunsamerica.com/digest/sig-sauer-p556-short-barrel-rifle-performance-pistol-new-gun-review-2/>.

<sup>88</sup> Nick Leghorn, *TTAG 2014 Editor’s Choice Award—Most Influential Personality of the Year: Alex Bosco*, SB Tactical (Dec. 22, 2014), <https://web.archive.org/web/20150206045745/http://www.sb-tactical.com/ttag-2014-personality-of-the-year-alex-bosco/> (emphasis in the original).

<sup>89</sup> David Higginbotham, *SIG SAUER P556, SHORT BARREL RIFLE PERFORMANCE FROM A PISTOL*, SB Tactical (Jun. 16, 2014), <https://web.archive.org/web/20150307044415/http://www.sb-tactical.com/sig-sauer-p556-short-barrel-rifle-performance-from-a-pistol-2/>; David M Fortier, *Shotgun News July 20th 2014—Always wanted a Short Barrel Rifle but won’t jump through the hoops? Here’s your solution*, SB Tactical (July 22, 2014), <https://web.archive.org/web/20150306211245/http://www.sb-tactical.com/shotgun-news-july-20th-2014>.

<sup>90</sup> SB Tactical, *Pistol Stabilizing Brace Shooting Techniques*, YouTube (July 29, 2016), <https://www.youtube.com/watch?v=FOTHRWSz64>.

<sup>86</sup> Specifically, *Haynes v. United States* rejected the government’s argument which cited *Sipes* for the proposition that two separate offenses occur for failure to register a firearm and subsequent possession of the firearm under 26 U.S.C. 5841 and 5851. 390 U.S. 85, 91 n.7 (1968).

<sup>87</sup> Alex C. *Gun Review: Sig SB15 Pistol Stabilizing Brace Review*, The Firearm Blog (Aug. 18, 2013), <https://www.thefirearmblog.com/blog/2013/08/18/sig-sb15-pistol-stabilizing-brace-review/> (“If you are like me, you remember seeing the Sig SB15 a while back and thinking ‘hey they hacked the NFA’. Of course we all know how it is supposed to be used, but let us get real and look at this objectively: Sig made an ‘arm brace’ and got ATF approval for said arm brace. The arm brace slides over a pistol buffer and looks like a stock . . . but it is an arm brace.”); Ryan Cross, *Sig Sauer SB15 Pistol Stabilizing Brace*, Firearms Insider Community (Sept. 14, 2014), <http://www.firearmsinsider.tv/gun-gear-reviews/>



**SB Tactical video describes this technique as “strap the brace to your arm.”**



**SB Tactical describes this technique as “cheek welding.”**





SB Tactical describes this technique as sternum mounting.



SB Tactical describes this technique as locking the pistol out on a fully tensioned sling.

**BILLING CODE 4410-FY-C**

In demonstrating these various firing techniques of a firearm equipped with its “stabilizing brace” models, the manufacturer’s video clearly shows it informed the public about and marketed its “brace” devices for uses that go far beyond the original design and intent of the “brace” as explained to ATF with the sample it submitted for evaluation. Further, the online marketing material showcasing these various shooting techniques highlight key objective design features, as described in this rule, that are consistent with a rifle that is designed, made, and intended to be fired from the shoulder. Even though the “brace” manufacturer notably did not include footage of a firearm with its “stabilizing brace” being fired from the shoulder, the video clearly demonstrates shooting of firearms equipped with its “stabilizing braces” from the sternum. This firing technique involves the shooter pressing the rear surface area against the shooter’s body (on the

sternum near the shoulder) to operate the firearm. Were the shooter to merely shift the firearm a few inches, the rear surface area provided by the “stabilizing brace” would effectively allow for firing from the shoulder. This technique indicates to the general community the ease and practicality of shouldering firearms equipped with “stabilizing braces.” Similarly, the video also demonstrates shooters using a “cheek welding” firing technique where the objective design features of a rifle are also evident. Based on the rear surface area provided by the “stabilizing brace” and the alignment of the sights, as seen in the video, the shooter can easily shoulder fire the weapon.

Further, at least one firearms manufacturer advertised the SB47, a later version of the SB15 “brace,” as a shoulder stock and stated that no short-barreled rifle NFA tax stamp

is required.<sup>91</sup> SB Tactical also posted an advertisement that the SB47 is “ATF approved for everybody[;] the SB47 does not require any special permits doctors [sic] notes or SBR tax stamp!”<sup>92</sup> Notably, the SB47 was not the same design as the original brace. The SB47 design was to be attached to an AK-type pistol rather than an AR-type pistol. SB Tactical posted a review of the SB47 where the reviewer generally stated that his first impression was that a firearm equipped with a SB47 is a short-barreled rifle, even though he stated that the reason for creating the SB15 and SB47 was to assist disabled veterans.<sup>93</sup>

<sup>91</sup> Century International Arms Inc., *SB47 Stabilizing Brace* (Sept. 6, 2013), <https://web.archive.org/web/20130906231317/http://centuryarms.biz/proddetail.asp?prod=OT1648>.

<sup>92</sup> SB Tactical, *SB47* (Mar. 17, 2015), <https://web.archive.org/web/20150317032957/http://www.sb-tactical.com/products/sb47/>.

<sup>93</sup> SB Tactical, *Gear Review: SB Tactical SB-47 Stabilizing Brace* (Mar. 15, 2014), <https://>

Numerous videos also demonstrate individuals using the SB15 and SB47 “stabilizing brace” from the shoulder.<sup>94</sup> Notably, some of these videos referenced a 2014 ATF letter in which FATD stated that using “braces” improperly (*i.e.*, shouldering them) would not constitute a design change.<sup>95</sup> In at least one video, an individual generally stated that it was lawful to shoulder the firearm and he knew what the “stabilizing brace” was for, *i.e.*, shouldering, but had not said it publicly until now because he did not want to be “that guy” prior to the 2014 letter.<sup>96</sup> These online materials demonstrate a general recognition by the firearms industry and certain firearms owners that a firearm equipped with an SB15 or SB47 “brace” included objective design features that indicated the firearm is a rifle designed and intended to be fired from the shoulder, even though such weapons had not been manufactured or transferred in accordance with the requirements of the NFA (depending on the barrel length). Numerous other online materials for “stabilizing braces,” including for Shockwave Blade, Strike Industries, and Gear Head Works Tailhook, display individuals using firearms marketed as pistols but shouldered as short-barreled rifles.<sup>97</sup>

[web.archive.org/web/20150307044345/http://www.sb-tactical.com/gear-review-sb-tactical-sb-47-stabilizing-brace-3/](http://web.archive.org/web/20150307044345/http://www.sb-tactical.com/gear-review-sb-tactical-sb-47-stabilizing-brace-3/) (“I had seen this piece of equipment online and immediately thought it was an SBR work-around.”); *id.* (stating that the original “brace” device “was designed to allow a veteran who lost the ability to do the things he loved, recapture that joy,” but acknowledging the “brace” device is “being misused as a[n] SBR stock”).

<sup>94</sup>Tactiholics, *ATF Compliant Sig SB15 Stabilizing Brace: Get One!*—Tactiholics™, YouTube (Nov. 19, 2014), <https://www.youtube.com/watch?v=rPaYGFjhwbc>; BigDaddyHoffman1911, *AK 47 Pistol with SB—47 Brace*, YouTube (July 27, 2014), <https://www.youtube.com/watch?v=zx-5lIM7iwo>; The Late Boy Scout, *The Awesome M85 AK Pistol with SB—47 Stabilizing Brace*, YouTube (Sept. 29, 2014), <https://www.youtube.com/watch?v=CKE2ELStak>; Jordan Winkler, *Century Arms C39V2 AK Pistol w/ SB Tactical Brace Review*, YouTube (May 10, 2017), <https://www.youtube.com/watch?v=l0w8sp43t8M>.

<sup>95</sup>In the letter, FATD advised that it does not classify weapons based on how an individual uses a weapon and that firing the pistol from the shoulder did not reclassify it as a short-barreled rifle. FATD further mentioned that some “brace” designs, such as the Sig Stability Brace, had not been classified as a shoulder stock and that therefore, using those “braces” improperly would not constitute a design change or change the classification of the weapon. Letter from ATF #301737 (Mar. 5, 2014).

<sup>96</sup>Military Arms Channel, *Shouldering a Handgun with a Sig SB15 Brace*, Military Arms Channel (Apr. 7, 2014), <https://www.youtube.com/watch?v=qNML018kl98>.

<sup>97</sup>Foghorn, *Gear Review: Shockwave Technologies Blade Pistol Stabilizer*, The Truth About Guns (Oct. 9, 2015), <https://www.thetruthaboutguns.com/gear-review-shockwave-technologies-blade-pistol-stabilizer/>; Brandon Harville, *7 Best AR—15 & AK Pistol Braces [Hands-*

Additionally, other publications and online videos are available regarding the use of various “braces” to fire from the shoulder, further demonstrating that firearms equipped with these “braces” were and are being used extensively as short-barreled rifles.<sup>98</sup>

*On & Video*], PewPew Tactical (June 2, 2021), <https://www.pewpewtactical.com/best-ar-pistol-braces/> (“It might look and function like a rifle, but thanks to the fact that AR—15 pistols don’t come built with a stock, they’re legally classified as pistols—giving them a full pardon from inconvenient NFA restrictions.” (emphasis omitted)); FocusTripp, *Best AR—15 Pistol Brace Under \$40—Foxtrox Mike VS KAK Shockwave Blade VS Trinity Force*, YouTube (June 15, 2019), <https://www.youtube.com/watch?v=IjQG4liORk>; Hoplopheil, *Shockwave Blade Brace 1.0 vs 2.0 Comparison*, YouTube (Jan. 27, 2020), [https://www.youtube.com/watch?v=W5-C6efbn\\_s](https://www.youtube.com/watch?v=W5-C6efbn_s); Tactical Hyve, *Navy SEAL “Coch” Talks About His AR Pistol Setup*, YouTube (Sept. 16, 2020), <https://www.youtube.com/watch?v=Zjfdavuh3vc>; AtlanticFirearms, *Draco AK47 Pistol with Brace at Atlantic Firearms*, YouTube (Aug. 9, 2019), <https://www.youtube.com/watch?v=JzxTs1-MwKI>; KB32 Tactical, *AR15 Pistol 10.5 Inch 100 Yard Test!! How’d She Do????*, YouTube (May 20, 2017), <https://www.youtube.com/watch?v=Pab-p6jcwL0>; 704 Tactical, *Strike Industries AR Pistol Stabilizer Brace*, YouTube (Jun. 4, 2020), [https://www.youtube.com/watch?v=Slf\\_IBxLzLg](https://www.youtube.com/watch?v=Slf_IBxLzLg); WorkTheTrigger, *Strike Industries Pistol Stabilizing Brace*, YouTube (May 19, 2020), <https://www.youtube.com/watch?v=BblldU84PQZU>; Jeremy S., *Gear Review: Gear Head Works Tailhook Pistol Braces (New Release)*, The Truth About Guns (Dec. 31, 2016), <https://www.thetruthaboutguns.com/gear-review-gear-head-works-tailhook-pistol-braces/> (“From the rear, if you’re thinking ‘gosh, that looks like it would be a great stock’ you’re darn right. As my CZ Scorpion Evo is a registered SBR I could legally shoulder the Tailhook and, I gotta say, the flat back and solid aluminum build make for as good of a shoulder stock as anything.”); sootch00, *Gear Head Works Tail Hook AR Pistol Brace*, YouTube (Mar. 16, 2017), <https://www.youtube.com/watch?v=FWXXMwa-Xk8>; Military Arms Channel, *B&T GHM9 9mm Pistol with Tailhook Brace!*, YouTube (Jan. 9, 2018), <https://www.youtube.com/watch?v=BnEk9PkMu84>.

<sup>98</sup>TFB TV, *Testing the Upgraded FS1913 Folding Brace*, YouTube (May 12, 2020), <https://www.youtube.com/watch?v=-VAJordA68> (individual testing a Ruger PC Charger with SBTactical FS1913 folding brace); Pew Pew Tactical, *Best AR—15 Pistol Braces: Truck Guns Ahoy!*, YouTube (July 2, 2019), <https://www.youtube.com/watch?v=uu2piCz8ThI> (stating that a firearm with a pistol brace is an alternative to building a short-barreled rifle and obtaining a tax stamp and reviewing the SB Mini, Shockwave Blade, SBM4, SBA4, SBA3, and the SBPDW while firing all the firearms from the shoulder); JPRifles, *SBA3 Pistol Stabilizing Brace—New Product Showcase—FEBRUARY 2019*, YouTube (Feb. 1, 2019), <https://www.youtube.com/watch?v=4qajpDzOyJQ> (reviewing the SBA3 stabilizing brace demonstrating fired from the shoulder only); Ballistic Staff, *CZ Scorpion Micro Folder: CZ Finally Adds Folding Brace to Popular Pistol*, Athlon Outdoors Network (Feb. 5, 2020), <https://www.ballisticmag.com/cz-scorpion-micro-folder-pistol/> (reviewing folding brace on CZ Scorpion pistol); ClassicFirearms, *You Can Have A Brace On A Glock?! (Recover 20/20 Brace)*, YouTube (July 28, 2021), [https://www.youtube.com/watch?v=seBxyshK\\_4](https://www.youtube.com/watch?v=seBxyshK_4) (firing a Glock pistol with a “stabilizing brace” from the shoulder); Mrgunsgear Channel, *SB Tactical SBPDW Review: Best Adjustable Brace For AR—15 Pistols?*, YouTube (Feb. 24, 2018),

The firearms industry’s and community’s prevalent use of the firearms as rifles, as highlighted in these videos, underscores why the Department has concluded that the assessment of whether a firearm falls within the statutory definition of a “rifle” should incorporate the objective design features of the firearm. Also, the recognition by firearms manufacturers and owners that “stabilizing brace” devices circumvented the NFA strongly supports the Department’s decision to re-evaluate its analysis of firearms equipped with “stabilizing braces.” Accordingly, the Department has determined the best approach is not to focus solely on stated intent or on the possibility that weapons with a “brace” might, in some circumstances, be fired with one hand. Rather, it is appropriate and necessary for the Department to clarify through this rulemaking the objective design features and other factors that indicate when a weapon that is equipped with an accessory, component, or other rearward attachment (*e.g.*, a “stabilizing brace”) is designed, made, and intended to be fired from the shoulder.

Lastly, the Department notes that neither the rule nor the relevant statutes ban “stabilizing braces” or the use of “stabilizing braces” on pistols. Indeed, this rule does not impose any new legal obligations on owners of “stabilizing braces” at all, as any obligations for these owners result only from the NFA and the GCA. Instead, this rule merely conveys more clearly to the public the objective design features and other factors that indicate a weapon is in fact a firearm or short-barreled rifle under the relevant statutes. Hence, an individual may continue to use such a device but may be subject to certain requirements depending on the firearm’s objective design features and other factors, as explained in this final rule.

<https://www.youtube.com/watch?v=c9ueVMFK-q0> (demonstrating SBPDW being fired from the shoulder); ClassicFirearms, *Manufacturer Review SB Tactical*, YouTube (Feb. 14, 2022), <https://www.youtube.com/watch?v=mC3M8T4LLSM> (reviewing SBA3, SBA4, SBPDW brace while firing from the shoulder and citing prior ATF letter which approves incidental shouldering); Mrgunsgear Channel, *SB Tactical SBA3 vs. SBA4: Which Is The Best AR—15 Pistol Brace?*, YouTube (Dec. 5, 2019), <https://www.youtube.com/watch?v=PWBHs2W8bxQ> (comparing the SBA3 and SBA4 while firing from the shoulder); Fire Mountain Outdoors, *SB Tactical PDW pistol brace overview* YouTube (Jan. 23, 2018), <https://www.youtube.com/watch?v=zPERkIXY2dM> (demonstrating the SBPDW as intended and shouldered); TheGunCollective, *I SWEAR IT’S NOT A STOCK—FLUX Defense Glock Pistol Brace*, YouTube (May 17, 2019), [https://www.youtube.com/watch?v=4PL5fUYA\\_sg](https://www.youtube.com/watch?v=4PL5fUYA_sg) (firing a Glock with a “stabilizing brace” from the shoulder).



ii. APA—Private Classification Letters  
Comments Received

Commenters said ATF's position is not clear because of the varying interpretations and different responses that ATF had provided through private letter classifications. They also stated that this past inconsistency results in the agency undermining its own legitimacy when it makes "a capricious and arbitrary change . . . after millions of Americans have legally purchased ['stabilizing braces'] with the understanding that ATF had approved them." Similarly, another commenter stated that it is difficult for the public to rely on ATF classifications for guidance because of the "vast variations in submissions" and the fact that "if even the smallest detail is changed (such as adding different sights, or a different optic), the entire firearm's classification could be inadvertently changed." (Quotation marks and emphasis omitted.)

Department Response

The Department does not agree with commenters that publishing this rule is arbitrary or capricious even if it results in prior classifications being no longer valid. As discussed above, ATF makes classifications based on the configuration of a particular firearm, as submitted to ATF, because attempting to make more general classifications may result in the erroneous application of the relevant statutes. There are many variations in firearms because of differences in weight, length, rear surface area, adjustability of a rearward attachment, length of pull, and sights or scopes, for example. Because private letter classifications are dependent on the specific configuration of the firearm, there may be different classifications for each unique firearm submitted, even if the weapons are outwardly similar. Moreover, some individuals and manufacturers were using ATF classification letters from a different device and applying that classification to a new device. This rule informs the public of the best interpretation of and the proper inquiry under the statutes by identifying relevant objective design features and other factors that are to be considered when determining how the statutory provisions apply to firearms equipped with "stabilizing braces" or other attachments. As discussed in this rule and the NPRM, ATF's review of the objective characteristics of the device is supported by Federal courts. See *Brandon*, 826 F.3d at 601–02. Additionally, ATF is publishing information simultaneously with this rule that will inform the public of both

(1) common weapon platforms with attached "stabilizing brace" designs and (2) examples of commercially available firearms equipped with a "stabilizing brace" that are short-barreled rifles.

iii. APA—Reliance by Public  
Comments Received

According to many commenters, ATF has approved the use of "a shooting support with a pistol" since at least 2006, and further, that pistol-braced firearms and pistol-brace accessories have been widely available and approved by ATF for sale since at least 2012. Commenters stated that millions of citizens were relying on ATF's guidance when making their purchase and took ATF at its word when the agency approved the installation of so-called "stabilizing braces" onto firearms in 2012. Another commenter contended that the proposed rule represented a clear change in position for ATF on "stabilizing braces." The commenter went on to say that "the Supreme Court recently made clear that an agency action may be 'arbitrary and capricious' because it fails to account for the reliance interests of those affected by the action." See *Dep't of Homeland Sec. v. Regents of the Univ. of California*, 140 S. Ct. 1891, 1913–15 (2020) ("*Regents*"). The commenter argued that the proposed rule could put millions of otherwise law-abiding Americans in danger of Federal criminal prosecution.

Department Response

The Department disagrees that the rule is arbitrary in that it failed to account for the reliance interests of those affected by the action. See *Regents*, 140 S. Ct. at 1913–15. In *Regents*, the Supreme Court considered the rescission of the Deferred Action for Childhood Arrivals programs and explained that, when an agency changes course from longstanding policies, reliance interests should be taken into account. *Id.* at 1913 (citing *Encino Motocars v. Navarro*, 579 U.S. 211, 222 (2016)). The Supreme Court further clarified that the agency was not required to consider all policy alternatives but was required to assess whether there were reliance interests, determine whether they were significant, and weigh any such interests against competing policy concerns. *Id.* at 1915.

While the Department acknowledges previous inconsistencies and the resulting confusion regarding ATF's private and public guidance on firearms equipped with "stabilizing brace" devices, ATF never declared that the marketing of a device as a "stabilizing

brace" when equipped on a firearm removes that firearm from the ambit of the NFA. Additionally, ATF's private classification letters were limited to the particular firearm configured with the particular device that it received from an individual, and its analysis was based on the objective design features of that device or firearm in addition to consideration of the individual's purported intent. Therefore, an individual's reliance on a classification for another person's device or firearm transfers the agency's specific analysis to a different context and hence is misplaced. Similarly, an individual's reliance on the statements of a "stabilizing brace" manufacturer or a firearms manufacturer—especially statements that may misrepresent the government's position—does not represent reliance on a government policy and hence is misplaced. The Department also notes that commenters are mistaken in their assertion that ATF has approved the use of "a shooting support with a pistol" since at least 2006. ATF's first response to an inquiry about "stabilizing" braces was in 2012, as described in section II.B of this preamble.

As it pertains to an individual's reliance on prior classification letters, ATF has notified the public that "classifications are subject to change if later determined to be erroneous or impacted by subsequent changes in law or regulations."<sup>99</sup> As previously discussed, ATF has discretion to correct its erroneous interpretations and rectify a firearms classification error, as occurred in many of ATF's "stabilizing brace" classifications. Thus, because of ATF's inherent discretion to correct its erroneous interpretations, and because ATF has explicitly provided notice that it has such discretion, any potential reliance interest is reduced.

Moreover, contrary to the assumption of commenters, this rule bans nothing. The Department has provided several courses of conduct that a person in possession of a firearm that is regulated by the NFA may select, including registration of the device in the NFRTR within a defined time period, which would permit an individual to lawfully possess the firearm. Additionally, the individual may reconfigure the firearm to remove it from the scope of the NFA (e.g., the removal and replacement of a barrel of less than 16 inches with a longer barrel) and maintain possession of the firearm. These alternatives

<sup>99</sup> ATF, National Firearms Handbook, sec. 7.2.4.1 (2009), <https://www.atf.gov/firearms/docs/guide/atf-national-firearms-act-handbook-atf-p-53208/download>.

demonstrate that the Department has considered the reliance interests of individuals and that any impact of this rule on individuals' perceived reliance interests will be minimal.

It is true that "the APA requires an agency to provide more substantial justification when . . . its prior policy has engendered serious reliance interests that must be taken into account." *Perez v. Mortg. Bankers Ass'n*, 575 U.S. 92, 106 (2015) (quoting *FCC v. Fox Television Stations, Inc.*, 556 U.S. 502, 515, (2009)). But in light of the options provided for compliance with the relevant statutes, the alleged reliance interest is minimal. The only interest identified is the avoidance of the NFA's making and transfer taxes, but these taxes will not be applied retroactively. Thus, any potential reliance interests are minimal because, in its enforcement discretion, the Department has determined that individuals and FFLs will not be required to pay these taxes. And any interest in avoiding the minor burden associated with registration of a rifle is also not significant. That is both because of the minimal time and expense required for registration and because possession of an unregistered rifle violates the law. *See Regents*, 140 S. Ct. at 1914 (noting that the Department of Homeland Security could have properly found that "reliance interests in benefits that [the agency] views as unlawful are entitled to no or diminished weight"). After carefully considering possible reliance interests, the Department thus finds that any reliance interests are outweighed by the need to properly and consistently apply the relevant statutes.

Moreover, an individual's reliance on ATF's prior positions cannot outweigh the effective enforcement of Federal firearms laws pursuant to the best interpretation of the plain language of the relevant statutes. Here, the Department seeks to inform the public of the objective criteria and other factors it will consider to determine when a firearm is designed, made, and intended to be fired from the shoulder so that the Department can effectively enforce the NFA and GCA and protect public safety. As discussed in this preamble, the NFA and GCA regulate short-barreled rifles by imposing additional tax, interstate-transportation, and interstate-transfer restrictions because Congress deemed them to be dangerous and unusual weapons. If certain firearms equipped with "stabilizing brace" devices are short-barreled rifles under the statutory definition, then the Department cannot permit the proliferation of the weapons in circumvention of the NFA.

#### iv. APA—Lack of Data

##### Comments Received

Several commenters highlighted a lack of data to justify the rule and said that ATF "provides no proof that these weapons are being fired from the shoulder." For example, one commenter stated the rule did not provide any analysis on the frequency with which pistol-braced firearms or short-barreled shotguns are being used in crime in order to justify the rule.

##### Department Response

The Department disagrees that there is a lack of data to justify the rule. Because, as discussed above, short-barreled rifles are among firearms historically considered by Congress to be unusual and dangerous, the agency is required to implement the NFA and ensure that firearms are properly classified and regulated. As discussed in the NPRM, there have been at least two mass shooting incidents where the shooters reportedly shouldered their weapons by using purported "stabilizing braces" as stocks,<sup>100</sup> killing a total of 19 people.<sup>101</sup> The Department need not wait for such incidents to become more frequent before taking steps to stop them. *See, e.g., Stilwell v. Off. of Thrift Supervision*, 569 F.3d 514, 519 (DC Cir. 2009) ("[A]gencies can, of course, adopt prophylactic rules to prevent potential problems before they arise. An agency need not suffer the flood before building the levee.") Further, as mentioned in section IV.A.2.a of this preamble, ATF has traced numerous firearms equipped with a "stabilizing brace" in connection with crimes in recent years, suggesting that weapons with "brace" devices are being used to commit crimes even apart from highly publicized incidents such as those in Boulder and Dayton.

<sup>100</sup> *See, e.g.,* Emily Davies, Tim Craig, and Hannah Natanson, *Ex-girlfriend Says Dayton Shooter Heard Voices, Talked about 'dark, evil things'*, The Washington Post (Aug. 5, 2019) [https://www.washingtonpost.com/national/police-chief-it-seems-to-defy-believability-that-dayton-shooter-would-kill-his-own-sister/2019/08/05/920a895c-b79e-11e9-b3b4-2bb69e8c4e39\\_story.html](https://www.washingtonpost.com/national/police-chief-it-seems-to-defy-believability-that-dayton-shooter-would-kill-his-own-sister/2019/08/05/920a895c-b79e-11e9-b3b4-2bb69e8c4e39_story.html) ("Dayton police spokeswoman Cara Zinski-Neace said Monday that Betts had modified his weapon so that he could stabilize it on his shoulder while firing. Betts had a 'pistol version' of an AR-15-style rifle, she said, not designed to be shouldered. But Betts added a brace."); Melissa Macaya et al., *10 killed in Colorado grocery store shooting*, CNN (updated Mar. 23, 2021), [https://www.cnn.com/us/live-news/boulder-colorado-shooting-3-23-21/h\\_0c662370eefaff05eac3ef8d5f29e94](https://www.cnn.com/us/live-news/boulder-colorado-shooting-3-23-21/h_0c662370eefaff05eac3ef8d5f29e94) (reporting that the firearm used in a shooting that killed 10 was an AR-15 pistol with an "arm brace").

<sup>101</sup> *See supra* note 67.

d. Violates the Americans with Disabilities Act ("ADA") or the Rehabilitation Act of 1973

##### Comments Received

Many commenters asserted that this rule violates the ADA or the Rehabilitation Act of 1973 and deprives thousands of gun owners who have disabilities from the joy of shooting their lawfully owned firearms. Specifically, commenters stated that "ATF is prohibited from making such discriminatory rules under [the ADA]" and that section 504 provides in part that "no qualified individual with a disability . . . shall be excluded from, denied the benefits of, or be subjected to discrimination under" any program or activity that . . . is conducted by any Executive agency. Several other commenters stated that "stabilizing braces" were first made and submitted for classification to assist persons with disabilities, and that ATF did not consider the impact the rule would have on disabled Americans. Another commenter stated that ATF's rulemaking, *i.e.*, the purported "activity" conducted by an Executive agency, "discriminates against disabled persons by arbitrarily limiting design characteristics [of 'braced' pistols] that enhance the effectiveness of the brace design for the disabled person." The commenter stated that there is no evidence that any of the restrictions—weight, adjustability, sights, overall length, length of pull—were determined after consideration of the needs of the disabled community and that these restrictions would adversely impact the disabled community, deny them the benefit of the product intended for them, and discriminate against them in violation of the ADA.

Other commenters said this rule would limit the future availability of "stabilizing braces" to the disabled community if the effect of the rule is to reclassify millions of "stabilizing brace"-equipped pistols as being subject to the NFA.

##### Department Response

The Department disagrees with commenters that the rule would violate the ADA. As an initial matter, the ADA applies to State and local governments; it does not apply to the Executive Branch of the Federal Government. *See* 42 U.S.C. 12131(1) (defining "public entity" as any State or local government; any department, agency, special purpose district, or other instrumentality of a State or States or local government; and the National Railroad Passenger Corporation, and any commuter authority). Accordingly,

because ATF is a Federal agency that is not subject to the ADA, the commenters' assertion that this regulation would violate the ADA is incorrect. In addition, commenters' ADA objections to the rule are misplaced because the rule does not itself ban or regulate any particular devices; instead, the rule articulates the Department's best interpretation of the relevant statutory provisions, which are the source of any restrictions or regulations on certain firearms.

In contrast to the ADA, the Rehabilitation Act of 1973 does apply to the Federal Government. However, this rule likewise does not violate that Act. Section 504 of the Rehabilitation Act prohibits the discrimination "solely by reason of disability" in Federally conducted programs and activities. 29 U.S.C. 794(a). The Rehabilitation Act "requires that people who are disabled within the meaning of the Act have meaningful access to the federal government's programs or activities." *National Ass'n of the Deaf v. Trump*, 486 F. Supp. 3d 45, 57 (D.D.C. 2020) (quotation marks omitted). The "relevant inquiry is whether those with disabilities are as a practical matter able to access benefits to which they are legally entitled." *Id.* (quotation marks omitted). As applied here, the classification of a firearm is not a "program or activity" as defined in section 794(b) of the Act. *See* 29 U.S.C. 794(b) (listing covered programs and activities). Second, no one is legally entitled to violate the NFA. Third, as explained below, neither the statute nor the rule denies or impedes anybody meaningful access to anything.

This rule does not restrict the use of a "stabilizing brace." A weapon with a "stabilizing brace" may be possessed without any NFA restrictions if that weapon falls outside the NFA's definition of "firearm," (*e.g.*, the weapon is not designed, made, and intended to be fired from the shoulder); thus, even after issuance of this rule, persons with disabilities will be able to purchase and use certain "stabilizing braces" without regulation under the NFA. Moreover, even a weapon with a "stabilizing brace" that falls within the definition of "firearm" in the NFA may be possessed and used if the statutory requirements are followed. All individuals who possess such a firearm may register that firearm in the NFRTR. There are other options available, discussed in section V.B of this preamble, for all individuals affected by the NFA's restrictions so they can continue to use a "stabilizing brace" while remaining in compliance with the law.

Finally, persons with disabilities are not denied benefits or subject to discrimination under this rule "solely by reason of their disability." This rule articulates the Department's best interpretation of the relevant statutory provisions, and ATF interprets and uniformly applies those provisions to every person. Notably, it appears that no commenter provided any specific information to suggest that this rule, or the NFA's requirements, would cause qualified individuals with disabilities, solely by reason of their disability, to be excluded from the participation in, subjected to discrimination under, or denied the benefits of any program or activity of ATF. Accordingly, there is nothing in the record to suggest that this rule would raise concerns under the Rehabilitation Act of 1973, and the Department disagrees that this rule "adversely impact[s] the disabled community, or [denies] them the benefit of the product intended for them."

## 2. Definition of "Rifle"

### Comments Received

The Attorney General of Ohio stated that DOJ's interpretation of "rifle" was arbitrary and had no basis in the statutory text. Another commenter argued that the definitions of "rifle" in the GCA and NFA are inconsistent and that ATF's interpretation in the NPRM confuses the existing regulations by introducing arbitrary and subjective factors. Thus, the commenters stated that ATF's claim of having proposed this rule to "clarify when a rifle is intended to be fired from the shoulder" is impossible to decipher. One commenter also stated that ATF's claim of clarifying when a rifle is intended to be fired from the shoulder is misleading to the public, and, thus, the public would misunderstand the purpose of the rule. The same commenter stated that there was no need for this purported amendment of the statutory definition of "rifle," as the rule should focus on approving or disapproving "stabilizing braces." Another commenter noted that the term "peripheral accessories"—a term used in the proposed regulatory text—lacked a proper definition.

### Department Response

The Department respectfully disagrees with the characterization that this interpretation of the term "rifle" is arbitrary and without statutory basis. Congress, in drafting the GCA and NFA, purposefully defined "rifle" broadly. Specifically, the GCA defines the term "rifle" as "a weapon designed or redesigned, made or remade, and

intended to be fired from the shoulder and designed or redesigned and made or remade to use the energy of an explosive to fire only a single projectile through a rifled bore for each single pull of the trigger." 18 U.S.C. 921(a)(7). The NFA defines the term "rifle" as "a weapon designed or redesigned, made or remade, and intended to be fired from the shoulder and designed or redesigned and made or remade to use the energy of the explosive in a fixed cartridge to fire only a single projectile through a rifled bore for each single pull of the trigger, and shall include any such weapon which may be readily restored to fire a fixed cartridge." 26 U.S.C. 5845(c). Despite slightly different wording, both statutes share a common focus in defining the term "rifle" in that whether a weapon is a rifle depends primarily on whether it is designed, made, and intended to be fired from the shoulder. This rule provides a clear explanation and guidance to both individual owners and manufacturers regarding the objective design features and other factors that indicate whether a firearm equipped with a "stabilizing brace" or other rearward attachment is a "rifle" designed, made, and intended to be fired from the shoulder.

Likewise, the Department disagrees with commenters that it is misleading the public when it claims that the purpose of the rule is to clarify when a rifle is designed, made, and intended to be fired from the shoulder. Due to inconsistent advice regarding how the use of a "stabilizing brace" device affected a classification and the resulting public confusion on the proper application of the NFA and GCA to firearms with "stabilizing braces," as described in the NPRM and this final rule, the Department seeks to inform the industry and public on the best interpretation regarding when "a firearm is designed . . . , made . . . , and intended to be fired from the shoulder" within the meaning of the relevant statutory terms.

Also, the Department disagrees that there is no need to clarify the term "rifle" and that ATF should focus on only approving or disapproving "stabilizing braces." As described earlier, the GCA and NFA regulate "firearms" and generally do not regulate the classification or use of individual components or accessories, standing alone. Accordingly, ATF generally does not classify components or accessories, unconnected to a particular firearm, under the GCA and NFA. However, components or accessories, when attached to a firearm, can affect the classification of a firearm because: (1) a component or an accessory's likely use



in the general community may be relevant in assessing the manufacturer's or maker's purported intent with respect to the design of a firearm; and (2) the design of a component or an accessory may result in a firearm falling within a particular statutory definition. Two examples would be: (1) the attachment of a secondary forward grip to a "pistol," where the resulting firearm would no longer be designed to be held and fired with a single hand; and (2) a wallet holster where the handgun can be fired while inserted, thus changing the classification of these handguns into an "any other weapon." See 26 U.S.C. 5845(e). A "stabilizing brace," of which there are many variations, is another example of an attachment that may affect the classification of the firearm to which it is attached. The question, however, remains whether the firearm as configured with the "brace" device is designed, made, and intended to be fired from the shoulder, even if the "stabilizing brace" has an alternate use that effectuates single-handed firing.

The rule's amendment to the definition of "rifle" does not use the term "accessory," and therefore the definition of that term is irrelevant to this rule. Nonetheless, if the term "accessory" is relevant, the Department maintains it would not be necessary to further provide a definition for this term.<sup>102</sup>

### 3. ATF Worksheet 4999

#### a. General Opposition to Worksheet 4999

##### Comments Received

There was general dissatisfaction with the proposed Worksheet 4999. Several commenters claimed that the worksheet was designed in such a way that the average person would not know if their handgun with an attached "stabilizing brace" was an NFA firearm without first obtaining a determination from FATD. Many commenters stated that they found the worksheet not only to be confusing and overly complex to determine if their firearm with a "brace" device is a rifle, but also that the worksheet was "rife with factual errors." The Ohio Attorney General argued that "the brace itself is not a 'weapon,'" so it "cannot be a rifle on its own," and another commenter stated "ATF has clearly approached this problem solely from the standpoint of a short-barreled rifle and has not

examined what features are useful for a pistol." Generally, commenters did not understand the reasoning behind Worksheet 4999, with one commenter stating that "[i]f the act of shouldering a pistol does not make it a [short-barreled rifle], why does it matter whether the stabilizing brace design encourages, discourages, or prevents shouldering?" They also claimed that the worksheet, which followed a complex, mathematical formula, was a radical departure from the GCA's definition of "rifle." One commenter said that ATF "make[s] a weak argument on how to objectively categorize pistols with braces versus [short-barreled rifles]."

One commenter argued that the proposed rule and Worksheet 4999 focused on factors that assess grip rather than factors that assess shouldering. By focusing on grip, the commenter argued, ATF's reasoning is "divorced from statutory text." The commenter argued that it unreasonable and unfair for ATF to adopt a rule that weighs indicia that braced pistols may be fired with two hands as evidence that the braced pistols are NFA firearms or GCA short-barreled rifles.

##### Department Response

As stated in the NPRM, the proposed Worksheet 4999, including the points assigned to each criterion, was intended to facilitate the evaluation by individuals or members of the industry of whether a weapon incorporating a purported "stabilizing brace" created a rifle and, possibly, a short-barreled rifle under the GCA and NFA. Worksheet 4999 was intended to ensure uniform consideration and application of the statutory definition of those terms. Based on the comments received, the Department agrees that the proposed Worksheet 4999 and point system did not achieve these intended purposes. The Department acknowledges commenters' concerns that the proposed worksheet was confusing and complex but disagrees that the worksheet was "rife with factual errors." The background section, above, highlights the objective characteristics considered in ATF's prior evaluations, including the weight of the firearm, the length of pull, the adjustability of the device attached to the firearm, the existence of a forward grip, and other accessories. The Department acknowledges in this rule that it had incorrectly included in the proposed regulatory changes some design characteristics that are not indicative of whether a firearm is designed and intended to be fired from the shoulder. As described in this rule, the relevant inquiry under the NFA and

GCA for the definition of "rifle" is whether the firearm is designed, made, and intended to be fired from the shoulder.

In this regard, the Department agrees with commenters like SB Tactical who argued that the NPRM and the worksheet improperly assessed gripping the firearm with one hand rather than assessing factors for shouldering the firearm because gripping with one hand is not relevant to the statutory inquiry of "rifle." Indeed, the Department agrees that the proposed analysis in the NPRM, vis-à-vis Worksheet 4999, continued to use the analysis from prior classifications that placed improper weight on whether the "stabilizing brace" at issue could be used as a "brace" to support single-handed fire, even if the objective design features of the firearm equipped with the "brace" indicated the weapon had been designed, made, and intended to be fired from the shoulder. In light of the comments, the final rule identifies and selects from the NPRM only those features that are relevant in determining whether a firearm is designed, made, and intended to be fired from the shoulder under the GCA and NFA. Therefore, design characteristics from the proposed Worksheet 4999 (e.g., stabilizing support or configuration, presence of hand stops and secondary grips, and presence of a bipod) are not included in this rule because they are not relevant to determine whether a firearm is designed, made, and intended to be fired from the shoulder.

The Department also agrees with commenters that a "stabilizing brace" itself is not a weapon, and therefore the Department updates the regulation to reflect how the ATF now classifies a firearm for purposes of the GCA and NFA—i.e., by assessing the firearm with the attached "brace" device as a whole. The Department disagrees that "ATF has clearly approached this problem solely from the standpoint of a short-barreled rifle and has not examined what features are useful for a pistol." After careful review and consideration, ATF recognizes that many prior classifications incorrectly weighed the utility of the purported "stabilizing brace" to allow for effective one-handed firing. The Department has determined, however, that the best interpretation of the statutory definitions requires an assessment that goes beyond the effectiveness of a "stabilizing brace" device for single-handed firing. The Department's interpretation of the statutes, as reflected in this rule, focuses on the objective design features of the firearm and the attached "stabilizing brace" to ensure that applying that

<sup>102</sup> Regarding the use of the term "accessory" in this rule, see *supra* note 35. For purposes of the AECA, ATF has consulted the definition of "accessory" found in 22 CFR 121.8, which is part of the International Traffic in Arms Regulations administered by the Department of State.

interpretation properly classifies firearms that are designed, made, and intended to be fired from the shoulder as “rifles,” even if such weapons might also be capable of one-handed fire. Because the Department has determined that the best interpretation of the statute calls for an assessment of whether the manufacturer’s stated intent is consistent with the objective design features of the firearm, this rule also includes consideration of marketing or promotional materials and likely use of the weapon in the general community among the factors to be considered in determining whether a weapon is designed and intended to be fired from the shoulder.

In clarifying the definition of “rifle,” this rule states that the term “designed or redesigned, made or remade, and intended to be fired from the shoulder” shall include a weapon that is equipped with an accessory, component, or other rearward attachment (e.g., a “stabilizing brace”) that provides surface area that allows the weapon to be fired from the shoulder, provided other factors, as listed below, indicate that that the weapon is designed, made, and intended to be fired from the shoulder:

- (i) whether the weapon has a weight or length consistent with the weight or length of similarly designed rifles;
- (ii) whether the weapon has a length of pull, measured from the center of the trigger to the center of the shoulder stock or other rearward accessory, component or attachment (including an adjustable or telescoping attachment with the ability to lock into various positions along a buffer tube, receiver extension, or other attachment method), that is consistent with similarly designed rifles;
- (iii) whether the weapon is equipped with sights or a scope with eye relief that require the weapon to be fired from the shoulder in order to be used as designed;
- (iv) whether the surface area that allows the weapon to be fired from the shoulder is created by a buffer tube, receiver extension, or any other accessory, component, or other rearward attachment that is necessary for the cycle of operations;
- (v) the manufacturer’s direct and indirect marketing and promotional materials indicating the intended use of the weapon; and
- (vi) information demonstrating the likely use of the weapon in the general community.

The Department believes that the rule’s final regulatory text reflects the best interpretation of the statutory text.

The objective design features in this rule are taken from the NPRM and also

can be identified on the proposed ATF Worksheet 4999, as discussed below.

(1) *Final Rule:* Surface area that allows the weapon to be fired from the shoulder.

Because both the GCA and NFA define a “rifle” as a weapon “designed . . . , made . . . , and intended to be fired from the shoulder,” the Department believes that a weapon equipped with a “brace” or other rearward attachment must first satisfy the requirement that it have surface area that allows for the weapon to be fired from the shoulder. A firearm that does not have surface area that allows for the weapon to be fired from the shoulder cannot qualify as a rifle.

The NPRM discussed the objective design feature of “surface area” and explained that some “stabilizing braces” provide larger, more substantial surface area to shoulder the firearm, while some “stabilizing braces” may provide less surface area. 86 FR at 30832. The NPRM discussed this factor in the context of the proposed Worksheet 4999, which included relevant subsections under Section II (Accessory Characteristics) and Section III (Configuration of Weapon). These subsections assessed points for the surface area provided by a “brace” device to shoulder a weapon and the attachment method of the “brace” on a firearm. The NPRM explained that the attachment method of the “stabilizing brace” provides insight as to how the firearm is intended to be used because material that extends the rear of the firearm toward the shooter serves as surface area that allows for shouldering the weapon and increases a firearm’s length of pull. *Id.* at 30831, 30833. Accordingly, this rule incorporates these concepts from the NPRM and proposed worksheet—the attachment method of the accessory and the surface area—under the objective design feature of “surface area” so that an assessment of whether a weapon that is equipped with an accessory or rearward attachment provides surface area that allows the weapon to be fired from the shoulder shall be the first step in determining that a weapon is rifle designed, made, and intended to be fired from the shoulder. In making the determination of whether surface area “allows” for shoulder firing, ATF will not attempt to precisely measure the surface area or make the determination based on the existence of any minimum surface area. Instead, ATF will consider whether there is any surface area on the firearm that can be used to shoulder fire the weapon. If the firearm includes surface area that can be used for shoulder firing the weapon, the weapon potentially qualifies as a “rifle”; in

contrast, if the weapon does not include such surface area, then it does not qualify as a “rifle.” To assess whether a potential rifle is in fact a rifle, ATF would then consider the other factors described below.

(2) *Final Rule:* Weight and length consistent with the weight and length of rifles.

This rule identifies weight and length as one of several objective design features in considering whether a firearm is designed, made, and intended to be fired from the shoulder. This factor is drawn from the NPRM, where the Department considered weight and length as a prerequisite for whether a “stabilizing brace” would be effective in stabilizing a firearm or whether the firearm would be too heavy to be fired from one hand. *Id.* at 30831, 30834. The NPRM stated that a firearm equipped with a “stabilizing brace” that was of a certain weight and within a length range equipped with a “stabilizing brace” would be a rifle because otherwise the firearm would be too heavy to be held by one hand. *Id.* Section I of the worksheet included the conditions for meeting the weight and length requirements. *Id.* at 30831. The weight of the firearm was again considered in Section III of the worksheet under peripheral accessories, where points were assessed if the weapon as configured weighed over 120 ounces. *Id.* at 30834. However, in response to comments pointing out that these lengths and weights were not necessarily dispositive of whether a firearm is intended to be fired from the shoulder, this rule considers the weight and length of a firearm equipped with a “brace” device against the weight and length of similarly designed rifles as a factor that can confirm whether a firearm, which has a rearward attachment that provides surface area for shouldering, is in fact a rifle.

(3) *Final Rule:* A length of pull, measured from the center of the trigger to the center of the shoulder stock or other rearward accessory, component, or attachment (including an adjustable or telescoping attachment with the ability to lock into various positions along a buffer tube, receiver extension, or other attachment method), that is consistent with similarly designed rifles.

The rule incorporates length of pull as an objective design feature from the NPRM because, as explained in the NPRM, it is a common measurement of firearms that describes the distance between the center of the firearm’s trigger and the rear center of the shoulder stock. *Id.* at 30833. A shoulder-fired weapon generally will have a length of pull that allows the placement

of the firearm's shouldering device against the shooter's shoulder while also ergonomically allowing the shooter to engage the firearm's trigger. The NPRM provided length of pull measurements consistent with shoulder-fired weapons and the Worksheet 4999 included a Length of Pull subsection under Section III (Configuration of Weapon). *Id.* at 30831. The NPRM also explained that the attachment method of the "stabilizing brace" provides insight as to how the firearm is intended to be used because material that extends the rear of the firearm towards the shooter serves as a shouldering device by increasing a firearm's length of pull. *Id.* at 30833. The Worksheet 4999 assessed two points for "Extended AR-type Pistol Buffer Tube," "Inclusion of Folding Adapter to extend length of pull," and "Use of 'spacers' to extend length of pull." *Id.* at 30831.

The length of pull feature encompasses the inclusion on the weapon of an adjustable or telescoping attachment with the ability to lock in various positions. This feature was described in the NPRM, which noted that adjustability is a characteristic commonly associated with shoulder stocks and a significant indicator that the device is designed and intended to be shouldered. *Id.* at 30832. Section II (Accessory Characteristics) of the worksheet included a subsection for adjustability. *Id.* at 30830. Additionally, Section III (Configuration of Weapon) of the worksheet assessed one point for a weapon that incorporates an "AR-type Pistol Buffer Tube with Adjustment Notches (KAK-type)," "Adjustable Rifle Tube," and "Adjustable PDW-type guide rails." *Id.* at 30831. An adjustable or telescoping attachment with the ability to lock into various positions along the rear of the firearm allows an individual to adjust a firearm's surface area toward the shooter and permits the shooter to place pressure on the rear of the device when firing the weapon without the device or attachment sliding forward.

This rule therefore clarifies that the objective design feature to be considered is length of pull that is consistent with similarly designed rifles, as measured from the center of the trigger to the center of the shoulder stock or other rearward accessory. This consideration necessarily includes whether the accessory is an adjustable or telescoping attachment with the ability to lock into various positions because an adjustable length of pull allows a shooter to exercise better control, improve accuracy, and maintain comfort when shooting based on the shooter's body or shooting preferences.

(4) *Final Rule*: Sights or scopes with eye relief that require shouldering of the firearm in order to be used as designed.

The final rule draws from the NPRM the concept that certain installed sights or scopes are indicators of intended use of firearm with an attached "stabilizing brace." *Id.* at 30834. The worksheet identified some types of sights that are only partially usable when firing the weapon with one hand. Sights that can only be used effectively when the weapon is shouldered were assigned more points on the worksheet. *Id.* For example, the Worksheet 4999 assessed one point for the "Presence of Rifle-type Back-up/Flip-up Sights/Or no sights"; two points for the "Presence of Reflex Sight with FTS Magnifier w/Limited Eye Relief"; and four points for the "Presence of a Sight/Scope with Eye Relief Incompatible with one-handed fire." *Id.* at 30831. For the final regulatory text, rather than list some specific types of sights or scopes, as attempted in the worksheet, the Department determined that the relevant inquiry for this objective design feature is whether the weapon is equipped with sights or a scope with eye relief that require the weapon to be fired from the shoulder in order to be used as designed. Sights or scopes that cannot be used without shouldering the weapon indicate that the firearm is designed, made, and intended to be fired from the shoulder.

(5) *Final Rule*: Necessary for the cycle of operations of the firearm.

The rule provides that ATF may also consider whether the surface area that allows the weapon to be fired from the shoulder is created by a buffer tube, receiver extension, component, or other rearward attachment that is necessary for the cycle of operations (*i.e.*, to expel a projectile by the action of an explosive). This consideration is drawn from the NPRM and the proposed Worksheet 4999, which assessed two points for "Extended AR-type Pistol Buffer Tube," "Inclusion of Folding Adapter extending length of pull," and "Use of 'Spacers' to extend length of pull." *Id.* at 30831. These extensions provide additional material to the firearm that is not required for the cycle of operations and, therefore, can be an indicator the firearm is designed, made, and intended to be fired from the shoulder. In contrast, material on a firearm that extends the rear surface area of the firearm toward the shooter but is required for the cycle of operations, such as an AR-type pistol with a standard 6 to 6-1/2 inch buffer tube, may be an indicator that the firearm is not be designed, made, and intended to be fired from the shoulder.

Even if a weapon is equipped with an accessory, component, or other rearward attachment (*e.g.*, a "stabilizing brace") that provides surface area that allows shouldering of the weapon, under the rule, whether the accessory, component, or other rearward attachment is necessary for the cycle of operations needs to be considered in determining whether a firearm is designed, made, and intended to be fired from the shoulder.

(6) *Final Rule*: Consideration of marketing or promotional materials and likely use of the weapon in the general community.

In addition, the NPRM discussed how ATF looks to a weapon's objective design features that can confirm or undermine the manufacturer's stated intent. *Id.* at 30827. The NPRM also provided, that "regardless of the points accrued" on the Worksheet 4999, "efforts to advertise, sell, or otherwise distribute 'short-barreled rifles' as such will result in a classification as a 'rifle'. . . because there is no longer any question that the intent is for the weapon to be fired from the shoulder." *Id.* at 30834; *see also id.* at 30829 (noting that certain firearms would not be classified as rifles "unless there [was] evidence that the manufacturer or maker expressly intended to design the weapon to be fired from the shoulder"). The rule, therefore, clarifies that marketing or promotional materials indicating the intended use of the weapon and any information demonstrating how the weapon with the attachment is likely to be used by the general community shall also be considered in determining whether the weapon is designed, made, and intended to be fired from the shoulder. These factors are considered in conjunction with the objective design features of the firearm equipped with a "stabilizing brace" to determine whether the firearm is designed, made, and intended to be fired from the shoulder.

The remainder of this section explains the comments received on the proposed Worksheet 4999 and point system and elaborates on the objective design features and other factors relevant in the determination of whether a weapon is a rifle. The Department also notes that, because prior ATF classifications of firearms equipped with a "brace" device did not all employ this correct understanding of the statutory terms, all such prior classifications are no longer valid as of May 31, 2023. Manufacturers that wish to sell firearms equipped with a "stabilizing device" may submit to FATD their firearm sample equipped



with its attachments for an evaluation and analysis consistent with this rule.

#### b. Worksheet 4999 Criteria and Point System

##### Comments Received

In addition to general opposition to the proposed Worksheet 4999, numerous commenters critiqued the factoring criteria, claiming they were either arbitrary or too complicated to understand. Despite ATF's statements in the NPRM regarding the purpose of the worksheet, commenters questioned whether the worksheet could provide uniform consideration and application because it contains ambiguous terms that are subject to interpretation and no measurable standards for many of the criteria. Numerous commenters argued that, under the proposed worksheet, "no pistol-braced firearms would count as a pistol," especially when applying Section II. The commenters claimed it was evident that ATF intended to classify everything with a barrel length under 16 inches as an NFA firearm. Similarly, some commenters claimed that most "braced" pistol firearms would fail the criteria on the worksheet and that the highly subjective factors would allow ATF to arbitrarily weigh points in favor of regulation under the NFA. One company expressed concern that its product would be classified as an NFA firearm under the proposed rule based merely on weight and length characteristics.

Other commenters stated that, although ATF purported to be publishing objective factoring criteria, the ATF Worksheet 4999 was subjective and that the new, design-based "features" such as weight and length, length of pull, or type and caliber, looked like they were designed and intended to derive a predetermined outcome. One commenter chastised ATF by stating "[i]t is clear that ATF can distinguish between a stock and a brace and is wrapping the application of braces into the 'stocked pistol' route to [a short-barreled rifle] despite their understanding and creation of the issue."

Numerous commenters also asserted that points were arbitrarily assigned without justification or explanation. Commenters asked questions such as how ATF determined that 4 points would be the standard to pass or fail the worksheet and believed that ATF's analysis, or lack thereof, of the factors was incorrect; and why did ATF not explain "why it is appropriate to use a rifle measurement when analyzing pistols." At least one commenter suggested that ATF should abandon the

point-based worksheet and replace it with "specific product guidelines on which specific stabilizing braces are effectively substitute shoulder stocks so that private citizens can easily determine whether any in their possession (or that they plan to purchase) would be lawful as-is or if an NFA stamp must be obtained."

In addition to comments that the points assigned were arbitrary, numerous commenters also raised other issues on certain criteria as they did not agree with how ATF characterized the factors and the associated issues.

##### Department Response

The Department agrees with commenters that the factoring criteria with a point system as proposed in the Worksheet 4999 were not easily understood or applied. The Department also agrees that some of the terms from the NPRM and worksheet were ambiguous and subject to interpretation. The Department also acknowledges that the NPRM's explanation for the assessment of points for specific factors was not as clear to the public as it had intended. However, the Department disagrees with the commenter who asserted that design features do not include a standard measurement. Likewise, the Department maintains the proposed factors were taken from prior ATF classifications pertaining to "stabilizing braces" and are consistent with the NFA and GCA.

Nevertheless, after careful review and consideration of the comments, the objective design features of rifles, and the administrative record, the Department does not adopt the proposed Worksheet 4999 and point system in this rule. The Department concluded the proposed Worksheet 4999 is unworkable first because Section II of the worksheet improperly considered the design of the "brace" separately from the configuration of the firearm. Further, Section III of the worksheet focused more on certain factors concerning the effectiveness of the "brace" in firing with a single hand rather than concentrating on rifle characteristics. The Department agrees that the proper inquiry in determining whether the firearm is designed, made, and intended to be fired from the shoulder should look at objective design features common to rifles. The Department recognizes that, even if a "stabilizing brace" may be used to support single-handed fire, this does not preclude a firearm from being designed, made, and intended to be fired from the shoulder under the relevant statutory provisions.

Because the Department recognizes that proposed Worksheet 4999 was flawed and that some of the terminology used was ambiguous, and that the factors indicated in Worksheet 4999 could have been applied subjectively based on the ambiguous terminology, the Department believes the objective design features adopted in this rule provide a more definitive method to determine when a firearm is designed, made, and intended to be fired from the shoulder. Additionally, this rule clarifies and simplifies the criteria from the Worksheet by describing clear and unambiguous objective design features that can be readily assessed. These assessments are summarized briefly here and discussed further below:

First, the weight and length of a firearm are quantifiable, easily measured metrics. ATF will measure the weight and length of the firearm while it is equipped with the "stabilizing brace" affixed to it. How ATF will evaluate the weight or length of firearms equipped with a "stabilizing brace" as compared to similarly designed rifles is described in section IV.B.3.b.i of this preamble.

Second, length of pull is a quantifiable and easily assessed measurement, and section IV.B.3.b.ix of this preamble provides a robust discussion on length of pull, how it is measured, the adjustability or telescoping ability of the "brace" on the firearm, and how it will be compared to other similarly designed rifles.

Third, the standard for sights or a scope that require shouldering to be used as designed can be measured by testing the sights or scope from the shoulder versus use with one hand. If the sights or scope can be used only while shouldering the firearm, this feature supports a conclusion that the firearm is a rifle. For further discussion, refer to section IV.B.3.b.xi of this preamble.

For these reasons, the Department agrees with the commenter who suggested that the point-based worksheet be abandoned; however, the Department does not find it administratively feasible to replace the worksheet with that commenter's suggestion of an exhaustive list of "braces." The rule provides clarification that a firearm designed, made, and intended to be fired from the shoulder includes a weapon that provides surface area that allows the weapon to be shouldered, provided the other factors discussed in this preamble and listed in the amended regulations also indicate the weapon is designed, made, and intended to be fired from the shoulder. The Department believes this final rule

allows for easier application by the firearms industry and individual firearm owners as compared to the approach in the NPRM and ATF's current approach. Also, ATF is publishing information simultaneously with this rule to inform members of the public of how they might be impacted based on (1) common weapon platforms with attached "stabilizing brace" designs and (2) examples of commercially available firearms with "stabilizing braces" that are short-barreled rifles. For such weapons, action such as registration in the NFRTR will need to be taken as discussed in section V.B of this preamble. Additionally, ATF will inform the public as new weapon systems and "stabilizing braces" or other devices become available.

i. Weight and Length Prerequisites

Comments Received

Many commenters did not agree with or understand ATF's rationale regarding weight and length as prerequisites before applying Worksheet 4999's factors to evaluate a firearm equipped with a "stabilizing brace." Commenters disputed ATF's statement from the NPRM that pistols that fall below the weight and length threshold are easily fired one-handed, and they asserted that the minimum and maximum weights seemed to be arbitrary prerequisites because the effectiveness of a "stabilizing brace" is related to balance, not its overall weight. Other commenters opined that it was not reasonable to have a minimum weight and length and that weapon weight does not have a bearing on the use of a "stabilizing brace." Another commenter stated that, according to the length and weight prerequisites, "our product, the Micro RONI® with Arm Support, [is] NFA regulated (requiring registration and tax payment)." Finally, one commenter stated that weight should not be a factor because there is no "bright line" size or weight of a gun

below which a "stabilizing brace" would never be useful.

Commenters also disagreed with the proposed minimum and maximum length requirements. One commenter stated that weapons over 26 inches may be fired from the hip using two hands and that ATF has historically recognized that weapons over 26 inches provide an appropriate platform for a brace. Likewise, the same commenter stated there are firearms under 12 inches that have a recoil higher in foot pounds than some AR15 pistols for which a "brace" would be needed. Another commenter disagreed with the overall length requirement and incorrectly asserted that "if two AR-type pistols equipped with a stabilizing brace have the same weight, but one has an overall length of 24 [inches] and the other has an overall length of 27 [inches], the latter would automatically be a short-barreled rifle" when "[i]n fact, the stabilizing brace would be more useful on the longer pistol because it will tend to be more 'front heavy'." In essence, this commenter did not understand why ATF concluded that only "handguns" may utilize a stabilizing brace. They argued that if a firearm is over 26 inches in length and features a secondary forward grip, the stabilizing brace would still be useful to allow single-handed shooting "*when the user decides to do that.*" (Emphasis in the original.)

The same commenter was troubled with the application of the weight factor, as it seemed to vary from section-to-section in Worksheet 4999 and as written, appeared to the commenter to "stack the deck in favor of disqualification." The commenter provided the example that in "Section I (where a lighter weight will reclassify a pistol as a short-barreled rifle) 'accessories' are removed," whereas "in Section III (where a heavier weight will reclassify a pistol as a short-barreled rifle) 'accessories' are not removed."

Department Response

The Department agrees with commenters that weight and length should not be used as prerequisites to determine whether use of a "stabilizing brace" on a given firearm effectively creates a rifle. The Department also agrees that there should not be an upper weight threshold of 120 ounces because there is no bright-line size of a gun for which a "stabilizing brace" would be useful. The Department, however, disagrees with the assertion that weight and length of a firearm are irrelevant to whether a firearm is designed, made, and intended to be fired from the shoulder. The purpose for using weight and length as prerequisites was to evaluate whether a "stabilizing brace" in fact could be practically used with heavy pistols. However, as previously discussed, the Department recognizes that focusing on whether a "stabilizing brace" can practically or effectively be used on a firearm for single-handed fire is not the correct inquiry. When a firearm equipped with a "stabilizing brace" has surface area that allows the firearm to be shoulder fired, it is helpful to compare the characteristics of that firearm to similar firearms that are designed, made, and intended to be fired from the shoulder to determine if the first firearm is a rifle. If the weight or length of the firearm in question is consistent with the weight or length of similarly designed rifles, then this would be an indicator that shoulder firing the weapon provides stabilization and is beneficial in firing the weapon, and thus that the firearm is designed, made, and intended to be used this way.

To further inform the public of examples of weights and lengths consistent with rifles, ATF's FATD weighed a variety of rifles, traditional and modern, from the National Firearms Collection.<sup>103</sup>

Manufacturer	Model	Caliber	Barrel length	Weight (pounds)
COLT	SMG	9x19mm	9½"	5.3
COLT	AR-15	.223 REM	16"	6
Q	HONEY BADGER	.300 BLK	7"	4.4
LWRC	M6	.223 REM	10½"	6
SIG SAUER	MCX	.223 REM	16"	7.9
SIG SAUER	MCX RATTLER	.300 BLK	6"	6
MAXIM DEFENSE	MDX	.223 REM	7"	5.1
MAXIM DEFENSE	PDX	.223 REM	6"	6
LRB ARMS	M15SA	.223 REM	7"	5.1
BCI DEFENSE	SQS15	.223 REM	8"	4.6
H&K	MK16	.223 REM	14"	6.6

<sup>103</sup> The National Firearms Collection is a firearms and ammunition collection for research that houses more than 12,000 firearms.

Manufacturer	Model	Caliber	Barrel length	Weight (pounds)
Z-M WEAPONS	LR300	.223 REM	16½"	7.1
OLYMPIC ARMS	M.F.R.	.223 REM	16"	7.9
ARSENAL	AKS-74U	.223 REM	8½"	5.7
ARSENAL	SAS M-7	7.62x39mm	16"	6.8
YUGOSLAVIA	AK-47	7.62x39mm	16"	5.7
ZASTAVA	AK-47	7.62x39mm	16"	6.8
IRAQ	TABUK	7.62x39mm	12"	7.9
RUSSIAN	KRINK	7.62x39mm	8"	5.5
MAGUA INDUSTRIES	MINI-BERYL	.223 REM	8"	7.1
H&K	MP5K	9x19mm	4½"	5.5
H&K	MP5	9x19mm	9"	4.2
H&K	UMP	.45 ACP	8"	4.4
BOBCAT WEAPONS	BW-5	9x19mm	9"	5.6
HK	USC	.45 ACP	16½"	6
S.W.D.	CM-11	9x19mm	17½"	6.2
S.W.D.	M-11/NINE	9x19mm	5½"	4.2
M.A.C.	M10	.45 ACP	5⅞"	6
MAC PMF	M11	.380 ACP	5½"	3.3
JERSEY ARMS	AVENGER	.45 ACP	6⅜"	6.2
RPB	M10	9x19mm	5⅞"	6.2
IMI	UZI	9x19mm	10"	5.5
IMI	MINI UZI	9x19mm	8"	5.5
IMI	MICRO UZI	9x19mm	5¼"	3.7
IMI	MICRO UZI	9x19mm	5⅜"	4.4
IWI	UZI PRO	9x19mm	6¾"	4.4
LWRC	SMG45	.45 ACP	8¾"	6
SIG SAUER	MPX	9x19mm	3½"	4
SIG SAUER	MPX	9x19mm	4½"	5.3
SIG SAUER	MPX	9x19mm	5½"	5.7
B&T	APC9	9x19mm	7"	6
B&T	TP9	9x19mm	6"	3.5
BERETTA	CX4 STORM	9x19mm	16¾"	5.7
BERETTA	CX4 STORM	.40 S&W	18"	5.1
DBX	5.7DBX	5.7x28mm	8"	3.7
CZ	EVO SCORPION	9x19mm	8"	5.3
CZ	EVO SCORPION	9x19mm	9"	6.7
CZECH	SKORPION	.32 ACP	4½"	3.1
GRAND POWER	STRIBOG SP9A1	9x19mm	8"	6
INTRATEC	MP9	9x19mm	5⅞"	3.7
INTRATEC	TEC-KG9	9x19mm	4¼"	5.3
CALICO	M900	9x19mm	16"	5.1
RUGER	PC CARBINE	9x19mm	16¼"	7.5
RECOVER TACTICAL	PI-X	9x19mm	4½"	4.2
FN	P90	5.7x28mm	12"	5.9
FN	PS90	5.7x28mm	18½"	6.6
HK	MP7	4.6x30mm	8"	4.4
KRISS	VECTOR	.45 ACP	6"	6.4
KRISS	VECTOR	.45 ACP	16"	7.3
HI-POINT	4095	.40 S&W	17⅝"	6.6
KEL-TEC	SUB2000	9x19mm	16⅞"	4
STEYR	MP40	9x19mm	9¾"	7.5
STEN	MK11	9x19mm	7¾"	5.7
FB	MSBS	.223 REM	17"	7.3
IWI	CARMEL	.223 REM	13½"	6.8
FN	SCAR-16	.223 REM	14"	7.5
FN	SCAR PDW-P	.223 REM	7½"	6.6
FN	FS2000	.223 REM	19"	7.7
CZ	BREN 805	.223 REM	11"	7.9
REMINGTON	700	.308 WIN	12½"	7.1
HK	HK93	.223 REM	13"	8.4
STEYR	AUG	.223 REM	21½"	8.4
STEYR	AUG	9x19mm	16¾"	7.7
WINCHESTER	1894	.30 W.C.F.	15"	6
GERMANY	STG44	7.92 KURTZ	16¼"	9.9
RUGER	MINI-14	.223 REM	18½"	7.1
KEL-TEC	SU-16	.223 REM	18½"	5.1
BERETTA	RX4 STORM	.223 REM	12½"	7.1
INLAND	M2 CARBINE	.30 CAL	18"	4.9
US	M2 CARBINE	.30 CAL	18"	4.6
BROWNING	BUCKMARK	.22LR	18"	4.9
MAUSER	C96	7.63x25mm	5½"	3.1
DWM	LUGER	9x19mm	7⅞"	2.9
DWM	LUGER	9x19mm	4¾"	3.1



Manufacturer	Model	Caliber	Barrel length	Weight (pounds)
MAUSER	C96	.30 Mauser	5 <sup>5</sup> / <sub>8</sub> "	3.5
MAUSER	C96	9x19mm	5 <sup>5</sup> / <sub>8</sub> "	3.3
GERMANY	STECHKIN	.380 ACP	5 <sup>5</sup> / <sub>8</sub> "	3.3
UNITED KINGDOM	MK6	.455 WEB	6"	5.5
STAR	1911	.38 Super	5"	4
BROWNING/FN	HI-POWER	9x19mm	4 <sup>3</sup> / <sub>4</sub> "	3.3
BERETTA	93R	9x19mm	6 <sup>1</sup> / <sub>4</sub> "	3.1
CAA	MCK CL	9x19mm	4"	2.9
CAA	MCK GEN 2	9x19mm	4"	3.7
FIRE CONTROL UNIT	X-01	9x19mm	3 <sup>7</sup> / <sub>8</sub> "	3.7
RECOVER TACTICAL	20/20N	9x19mm	4 <sup>1</sup> / <sub>2</sub> "	2.2
FAB DEFENSE	KPOS G2	9x19mm	9"	3.7
ACCURATE PISTOL SYSTEMS	GLOCK 17	9x19mm	4 <sup>1</sup> / <sub>2</sub> "	2.9
ENDO TACTICAL	GLOCK 17	9x19mm	4 <sup>1</sup> / <sub>2</sub> "	2.6
TAC STOCK	GLOCK 17	9x19mm	4 <sup>1</sup> / <sub>2</sub> "	2
CALICO	M-100	.22LR	17 <sup>7</sup> / <sub>8</sub> "	4.6
UMAREX	HK 416D	.22LR	16 <sup>1</sup> / <sub>4</sub> "	6.6
ISSC	MK22	.22LR	16 <sup>1</sup> / <sub>2</sub> "	6.6
GSG	GSG-522	.22LR	16 <sup>3</sup> / <sub>8</sub> "	6.2
DAISY MFG	N/A	.22LR	16 <sup>1</sup> / <sub>4</sub> "	3.3
HENRY	LEVER ACTION	.22LR	16 <sup>1</sup> / <sub>8</sub> "	5.1
REMINGTON	MODEL 597	.22LR	20"	5.3
SPRINGFIELD	M6 SURVIVAL	.22LR	18 <sup>1</sup> / <sub>4</sub> "	3.6
ITHACA	M6 SURVIVAL	.22LR	14 <sup>1</sup> / <sub>4</sub> "	3.7
CHARTER ARMS	AR-7	.22LR	16 <sup>1</sup> / <sub>8</sub> "	2.6
RUGER	22-Oct	.22LR	18 <sup>5</sup> / <sub>8</sub> "	5.1
KSA	CRICKET	.22LR	16 <sup>1</sup> / <sub>4</sub> "	2.9

Similarly, ATF's FATD measured the length of numerous rifles available in the National Firearms Collection to provide an example of lengths of rifles.

Manufacturer	Model	Caliber	Barrel length	Overall length
COLT	SMG	9x19mm	9 <sup>1</sup> / <sub>2</sub> "	27"
COLT	AR-15	.223 REM	16"	33"
Q	HONEY BADGER	.300 BLK	7"	24"
LWRC	M6	.223 REM	10 <sup>1</sup> / <sub>2</sub> "	28"
SIG SAUER	MCX	.223 REM	16"	33 <sup>1</sup> / <sub>2</sub> "
SIG SAUER	MCX RATTLER	.300 BLK	6"	32 <sup>1</sup> / <sub>4</sub> "
MAXIM DEFENSE	MDX	.223 REM	7"	23 <sup>1</sup> / <sub>4</sub> "
MAXIM DEFENSE	PDX	.223 REM	6"	22"
LRB ARMS	M15SA	.223 REM	7"	24 <sup>1</sup> / <sub>2</sub> "
BCI DEFENSE	SQS15	.223 REM	8"	23 <sup>1</sup> / <sub>2</sub> "
H&K	MK16	.223 REM	14"	30 <sup>1</sup> / <sub>4</sub> "
Z-M WEAPONS	LR300	.223 REM	16 <sup>1</sup> / <sub>2</sub> "	35"
OLYMPIC ARMS	M.F.R.	.223 REM	16"	36 <sup>1</sup> / <sub>2</sub> "
ARSENAL	AKS-74U	.223 REM	8 <sup>1</sup> / <sub>2</sub> "	27"
ARSENAL	SAS M-7	7.62x39mm	16"	34 <sup>3</sup> / <sub>4</sub> "
YUGOSLAVIA	AK-47	7.62x39mm	16"	34 <sup>1</sup> / <sub>4</sub> "
ZASTAVA	AK-47	7.62x39mm	16"	34 <sup>3</sup> / <sub>4</sub> "
IRAQ	TABUK	7.62x39mm	12"	31 <sup>1</sup> / <sub>2</sub> "
RUSSIAN	KRINK	7.62x39mm	8"	26"
MAGUA INDUSTRIES	MINI-BERYL	.223 REM	8"	26"
H&K	MP5K	9x19mm	4 <sup>1</sup> / <sub>2</sub> "	21 <sup>1</sup> / <sub>2</sub> "
H&K	MP5	9x19mm	9"	26"
H&K	UMP	.45 ACP	8"	27 <sup>3</sup> / <sub>4</sub> "
BOBCAT WEAPONS	BW-5	9x19mm	9"	26 <sup>3</sup> / <sub>4</sub> "
HK	USC	.45 ACP	16 <sup>1</sup> / <sub>8</sub> "	34 <sup>3</sup> / <sub>4</sub> "
S.W.D.	CM-11	9x19mm	17 <sup>1</sup> / <sub>8</sub> "	30 <sup>5</sup> / <sub>8</sub> "
S.W.D.	M-11/NINE	9x19mm	5 <sup>1</sup> / <sub>2</sub> "	22 <sup>1</sup> / <sub>8</sub> "
M.A.C.	M10	.45 ACP	5 <sup>7</sup> / <sub>8</sub> "	19 <sup>1</sup> / <sub>8</sub> "
MAC PMF	M11	.380 ACP	5 <sup>1</sup> / <sub>8</sub> "	18 <sup>1</sup> / <sub>2</sub> "
JERSEY ARMS	AVENGER	.45 ACP	6 <sup>3</sup> / <sub>8</sub> "	22 <sup>1</sup> / <sub>2</sub> "
RPB	M10	9x19mm	5 <sup>7</sup> / <sub>8</sub> "	22"
IMI	UZI	9x19mm	10"	25 <sup>3</sup> / <sub>4</sub> "
IMI	MINI UZI	9x19mm	8"	23 <sup>3</sup> / <sub>4</sub> "
IMI	MICRO UZI	9x19mm	5 <sup>1</sup> / <sub>4</sub> "	19 <sup>1</sup> / <sub>4</sub> "
IMI	MICRO UZI	9x19mm	5 <sup>3</sup> / <sub>8</sub> "	19 <sup>1</sup> / <sub>4</sub> "
IWI	UZI PRO	9x19mm	6 <sup>3</sup> / <sub>4</sub> "	21 <sup>1</sup> / <sub>4</sub> "
LWRC	SMG45	.45 ACP	8 <sup>3</sup> / <sub>4</sub> "	24 <sup>1</sup> / <sub>2</sub> "

Manufacturer	Model	Caliber	Barrel length	Overall length
SIG SAUER	MPX	9x19mm	3½"	18¾"
SIG SAUER	MPX	9x19mm	4½"	21¾"
SIG SAUER	MPX	9x19mm	5½"	22"
B&T	APC9	9x19mm	7"	23¼"
B&T	TP9	9x19mm	6"	20½"
BERETTA	CX4 STORM	9x19mm	16¾"	30½"
BERETTA	CX4 STORM	.40 S&W	18"	29½"
DBX	5.7DBX	5.7x28mm	8"	23"
CZ	EVO SCORPION	9x19mm	8"	26"
CZ	EVO SCORPION	9x19mm	9"	30¼"
CZECH	SKORPION	.32 ACP	4½"	20½"
GRAND POWER	STRIBOG SP9A1	9x19mm	8"	24½"
INTRATEC	MP9	9x19mm	5½"	21"
INTRATEC	TEC-KG9	9x19mm	4¼"	21½"
CALICO	M900	9x19mm	16"	37"
RUGER	PC CARBINE	9x19mm	16¼"	35½"
RECOVER TACTICAL	PI-X	9x19mm	4½"	25½"
FN	P90	5.7x28mm	12"	19½"
FN	PS90	5.7x28mm	18½"	26"
HK	MP7	4.6x30mm	8"	23"
KRISS	VECTOR	.45 ACP	6"	24½"
KRISS	VECTOR	.45 ACP	16"	35¼"
HI-POINT	4095	.40 S&W	17½"	32¼"
KEL-TEC	SUB2000	9x19mm	16½"	29¼"
STEYR	MP40	9x19mm	9¾"	32"
STEN	MK11	9x19mm	7¾"	30"
FB	MSBS	.223 REM	17"	34"
IWI	CARMEL	.223 REM	13½"	28½"
FN	SCAR-16	.223 REM	14"	32½"
FN	SCAR PDW-P	.223 REM	7½"	27"
FN	FS2000	.223 REM	19"	29"
CZ	BREN 805	.223 REM	11"	30"
REMINGTON	700	.308 WIN	12½"	31¾"
HK	HK93	.223 REM	13"	34"
STEYR	AUG	.223 REM	21½"	31¼"
STEYR	AUG	9x19mm	16¾"	26"
WINCHESTER	1894	.30 W.C.F.	15"	33"
GERMANY	STG44	7.92 KURTZ	16¼"	36¾"
RUGER	MINI-14	.223 REM	18½"	37¾"
KEL-TEC	SU-16	.223 REM	18½"	37½"
BERETTA	RX4 STORM	.223 REM	12½"	33½"
INLAND	M2 CARBINE	.30 CAL	18"	36"
US	M2 CARBINE	.30 CAL	18"	37½"
BROWNING	BUCKMARK	.22LR	18"	33½"
MAUSER	C96	7.63x25mm	5½"	25"
DWM	LUGER	9x19mm	7⅞"	26"
DWM	LUGER	9x19mm	4¾"	22"
MAUSER	C96	.30 Mauser	5⅝"	24⅞"
MAUSER	C96	9x19mm	5⅝"	25"
GERMANY	STECHKIN	.380 ACP	5⅝"	21"
UNITED KINGDOM	MK6	.455 WEB	6"	23¾"
STAR	1911	.38 Super	5"	23"
BROWNING/FN	HI-POWER	9x19mm	4¾"	21⅞"
BERETTA	93R	9x19mm	6¼"	22½"
CAA	MCK CL	9x19mm	4"	23"
CAA	MCK GEN 2	9x19mm	4"	22¾"
FIRE CONTROL UNIT	X-01	9x19mm	3⅞"	20½"
RECOVER TACTICAL	20/20N	9x19mm	4½"	19"
FAB DEFENSE	KPOS G2	9x19mm	9"	23½"
ACCURATE PISTOL SYSTEMS	GLOCK 17	9x19mm	4½"	21¼"
ENDO TACTICAL	GLOCK 17	9x19mm	4½"	23½"
TAC STOCK	GLOCK 17	9x19mm	4½"	21⅝"
CALICO	M-100	.22LR	17⅞"	35⅝"
UMAREX	HK 416D	.22LR	16¼"	35¼"
ISSC	MK22	.22LR	16½"	33¼"
GSG	GSG-522	.22LR	16¾"	33¾"
DAISY MFG	N/A	.22LR	16¼"	32¼"
HENRY	LEVER ACTION	.22LR	16⅞"	33⅞"
REMINGTON	MODEL 597	.22LR	20"	38½"
SPRINGFIELD	M6 SURVIVAL	.22LR	18¼"	32"
ITHACA	M6 SURVIVAL	.22LR	14¼"	27⅞"
CHARTER ARMS	AR-7	.22LR	16⅞"	35⅞"
RUGER	22-Oct	.22LR	18⅝"	36¾"

Manufacturer	Model	Caliber	Barrel length	Overall length
KSA .....	CRICKET .....	.22LR .....	16¼"	30⅞"

Although the above weights and lengths for rifles are not themselves determinative, the Department also notes that many heavy pistols have the receiver of a rifle with the stock removed and that the firearm with a pistol grip is a variant of a rifle.<sup>104</sup> These heavy pistols are often lighter or shorter than the rifle version but reach the same weight and length of their rifle predecessor when equipped with a “stabilizing brace” device. Many firearms that incorporate “stabilizing brace” devices are variants of rifles (*e.g.*, AR and AK-type pistols), which often incorporate receivers that accept cartridges primarily designed for rifles. For a firearm marketed as a pistol that is a variant of a rifle, ATF would compare the weight and length of the firearm with an attached “stabilizing brace” (or other device attached) against the original rifle design. For a firearm that is not a variant of a rifle (*e.g.*, a Glock-type pistol), the weight and length of the firearm with an attached “stabilizing brace” (or other device attached) would be compared to the weight or length range of variants designed, made, and intended to be fired from the shoulder (*e.g.*, a Glock-type pistol with a shoulder stock or installed into a carbine conversion kit). When a firearm with an attached “brace” device has a weight or length comparable to rifles, that weight or length is an indication that the firearm is designed, made, and intended to be fired from the shoulder.

The Department agrees with one commenter’s concerns regarding the outcome under the proposed Worksheet 4999 in a scenario in which two firearms with an attached “brace”

<sup>104</sup> ATF Final Rule 2021R-05F revised the definition of the term “frame or receiver” to provide that a “receiver” means “the part of a rifle, shotgun, or projectile weapon other than a handgun, or variants thereof, that provides housing or a structure for the primary component designed to block or seal the breech prior to initiation of the firing sequence (*i.e.*, bolt, breechblock, or equivalent), even if pins or other attachments are required to connect such component to the housing or structure.” 87 FR at 24735. The rule also defined the term “variant” and “variants thereof” [to] mean a weapon utilizing a similar frame or receiver design irrespective of new or different model designations or configurations, characteristics, features, components, accessories, or attachments. For example, an AK-type firearm with a short stock and a pistol grip is a pistol variant of an AK-type rifle, an AR-type firearm with a short stock and a pistol grip is a pistol variant of an AR-type rifle, and a revolving cylinder shotgun is a shotgun variant of a revolver.” *Id.*

device weigh the same and one is 25 inches in length and the other is 27 inches in length. The latter firearm under the worksheet would have been classified as a rifle when equipped with a “stabilizing brace,” not a short-barreled rifle as asserted by the commenter, on the basis that a firearm with an overall length exceeding 26 inches would be impractical and inaccurate to fire one handed due to the imbalance of the weapon, and thus would need to be shouldered. Notably, the weight and length prerequisites in the worksheet were considered in the context of whether the firearm is practical to fire with a single hand rather than whether the firearm is designed and intended to be fired from the shoulder. The rule no longer focuses on whether the overall length of the firearm (*i.e.*, 12 to 26 inches) is suitable for installing a “stabilizing brace” device. Rather, the Department believes the statute is best interpreted to include consideration of the weight or length of a firearm with a “stabilizing brace” and a rear surface area that allows firing from the shoulder as one of the objective design features indicating whether the weapon is designed, made, and intended to be fired from the shoulder.

While at least one commenter expressed concern that the proposed worksheet “stack[ed] the deck in favor of disqualification” and would result in many pistol-braced firearms being classified as rifles, the Department recognizes that, under the best interpretation of the statutory terms, a majority of firearms equipped with a “stabilizing brace” currently or previously available on the market likely have the requisite design features indicating that the firearm is designed or redesigned, made or remade, and intended to be fired from the shoulder. As previously discussed in section IV.B.1.c.i of this preamble, many firearms owners and industry members use firearms equipped with “stabilizing braces” as shoulder fire weapons to effectively circumvent the requirements of the NFA. Therefore, it is necessary for the Department to apply clear and consistent standards to properly regulate these firearms.

## ii. Weight and Length Prerequisite—Inclusion of Accessories

### Comments Received

Several commenters stated that the worksheet was confusing because it did not clearly explain whether the “stabilizing brace” and other accessories were to be attached to the firearm when measuring the relevant lengths and weights. One commenter opined that the worksheet provided that overall length would have been measured “with all non-operational accessories removed,” and it was unclear what “non-operational accessories” meant in this context, especially given the worksheet’s definition of accessory, which seemed to include only stabilizing braces. The same question was raised when it came to determining the minimum weight, as the commenter said it is unclear how the firearm would be weighed, *i.e.*, with only the “stabilizing brace” removed or whether other accessories (*e.g.*, sights, forward pistol grip, bipod, *etc.*) should be removed as well.

### Department Response

The Department notes that, in not adopting Worksheet 4999 and the associated point system, this rule addresses commenters’ concerns regarding the different ways ATF was to weigh or measure the firearm (*i.e.*, either with or without accessories, including “stabilizing braces”). In considering whether a firearm’s weight and length are consistent with that of rifles, FATD, under the final rule, will weigh a submitted firearm sample with all of the accessories attached and an empty magazine. Additionally, the overall length of the firearm will be measured with the “stabilizing brace” attached and fully extended, with the firearm to be measured from the rearmost point of the butt plate or grip. The Sporting Arms and Ammunition Manufacturers’ Institute, Inc. (“SAAMI”) identifies the overall length of a firearm as: “The dimension measured parallel to the axis of the bore from the muzzle to a line at right angles to the axis and tangent to the rearmost point of the butt-plate or grip.”<sup>105</sup> Similarly, ATF will apply the overall length standard that it uses to measure a weapon made from a shotgun

<sup>105</sup> SAAMI, *Glossary*, Sporting Arms and Ammunition Manufacturers’ Institute, Inc., <https://saami.org/glossary/overall-length/> (last visited Jan. 6, 2023).



or a rifle for purposes of 27 CFR 479.11 to measure the overall length for rifles. This standard is “the distance between the extreme ends of the weapon measured along a line parallel to the center line of the bore.” 27 CFR 479.11.

iii. Weight and Length Prerequisites—  
Shooting Orientation

Comments Received

At least one commenter argued that ATF wrongly identified the weight factor, stating “if I had a pistol that weighed more than 7–1/2 pounds, I would want a stabilizing brace. And I would probably fire from a bench rest (setting the front of the gun on a sandbag) or from another supported position such as prone (perhaps using a bipod) or seated (resting an elbow on a knee). All of these are well-known shooting positions.”

Department Response

The Department disagrees that the method in which a “stabilizing brace” may be used, in isolated circumstances or by a single individual, is relevant to examining whether a firearm is designed, made, and intended to be fired from the shoulder. The Department has determined that the definition of “rifle” in the relevant statutes should not be based solely on how a single individual plans to use a weapon. For instance, one commenter provided an example of using a brace on a pistol that weighs more than 7–1/2 pounds; the commenter said he would want to fire it from a bench rest or a prone or seated position. In fact, rifles designed, made, and intended to be fired from the shoulder can be fired from a bench rest, as well as from a prone or seated

position, as demonstrated below.<sup>106</sup> The individual’s personal intent to fire the weapon from a bench rest thus does not preclude a conclusion that the weapon in question is nonetheless designed, made, and intended to be fired from the shoulder.

**BILLING CODE 4410-FY-P**

<sup>106</sup> See Lou Patrick, *Bench Rest Shooting Fundamentals*, Shoot On, <https://shoot-on.com/bench-rest-shooting-fundamentals/> (last visited Dec. 12, 2022); Keith Wood, *How to Shoot Your Best from a Benchrest*, RifleShooter (Aug. 5, 2014), <https://www.rifleshooter.com/editorial/boost-benchrest-shooting-skills/83631>; Dave Campbell, *Back to Basics: Shooting Support*, NRA American Rifleman (July 13, 2018), <https://www.americanrifleman.org/content/back-to-basics-shooting-support/>; Frank Galli, *Long Range Shooting: Precision Marksmanship Fundamentals*, RECOIL—Firearm Lifestyle Magazine ([recoilweb.com](http://recoilweb.com)), (Jan. 7, 2021), <https://www.recoilweb.com/long-range-shooting-precision-marksmanship-fundamentals-163796.html>.



***NRA American Rifleman***

An individual shooting rifle from seated position.



***Shoot On***

An individual shooting a rifle from a bench rest position.



***RECOIL – Firearm Lifestyle Magazine (recoilweb.com)***

An individual shooting a rifle from the prone position.

The Department has determined that making classifications based solely on the way a particular individual uses a firearm equipped with a “stabilizing brace” would not effectively implement the statutory scheme. Doing so would lead to the absurd result that a firearm is not designed, made, and intended to be fired from the shoulder simply because one user happens to fire it with one hand, regardless of whether other evidence of the weapon’s purpose—principally, its objective design features as described in this final rule—indicate it was designed, made, and intended to be fired from the shoulder.

#### iv. Weight and Length Prerequisites—Shooters’ Physical Abilities

##### Comments Received

Other commenters stated that weight limits, whether minimum or maximum, were arbitrary because “[s]ome people are stronger than others” and the rule did not account for the physical abilities or limitations of those individuals with disabilities. Another commenter agreed: “Using weight and length as determinative factors will create a subjective and overbroad control because the ability to handle any firearm varies among users[.]” Another commenter, who argued the four-pound minimum was arbitrary, stated that ATF provided no analysis showing the distribution of shooters the agency believes can “easily” fire a “traditional” pistol with one hand, nor did it address pistols lighter than the AR15 pistol that are more in need of a “brace” device to control a firearm’s recoil. Similarly, other commenters claimed that ATF “[f]ail[ed] to acknowledge the need for . . . lighter weight, smaller size firearms as teaching tools and practical firearms for those with advanced physical challenges.” Regarding the weight threshold, one commenter stated that the “excessively high lower limit on weight will tend to affect the old, the neurologically impaired, and smaller, weaker individuals.” Another commenter pointed out that “a firearm that is considered heavy and long by a small statured person could just as easily be considered light and short by a larger framed person.”

##### Department Response

The Department disagrees that any minimum or maximum weight is arbitrary because of the subjective sizes or disabilities of individuals. Neither the GCA nor the NFA classifies firearms based upon a particular individual shooter’s strength, height, disability, or other personal trait—and neither does ATF. Although ATF considers a maker’s

or manufacturer’s purported intent as reflected in marketing and promotional materials, or other information demonstrating the likely use by the general community, the statute calls for an assessment of whether the maker’s or manufacturer’s stated intent is consistent with the firearm’s objective design features. Although the Department acknowledges that there may be certain individuals who, because of their particular physical characteristics, may find it easier to or harder to fire certain weapons with one hand, the fact that a weapon, in certain circumstances, is capable of one-handed fire does not preclude a conclusion that the weapon is designed, made, and intended to be fired from the shoulder. The statutory definition of “rifle,” in other words, does not turn on potential alternate uses of the weapon in question, as explained above.

In response to commenters concerned about the use of “stabilizing braces” on smaller firearms by persons with physical or neurological disabilities, the Department notes that an individual may still possess and use a firearm equipped with a “stabilizing brace,” but the firearm could be subject to the NFA. In addition, such a person may be able to purchase a “stabilizing brace” that, when attached to the weapon in question, does not make the weapon a “rifle” based on the objective design features and other evidence, as listed in this rule. As earlier discussed in section IV.B.1.d of this preamble, a person with a disability who is in possession of a firearm is not exempt from complying with the applicable provisions of the NFA.

#### v. Accessory Design

##### Comments Received

A commenter said Section II (Accessory Design) of Worksheet 4999 relied on the interpretation of the vague criteria. Numerous other commenters stated that it was unclear what “known stock design” means and questioned how individuals are supposed to know every single stock design to determine if the accessory is suitable as a “brace” or device.

##### Department Response

The Department agrees the criteria to evaluate an attachment or purported “stabilizing brace” design on the proposed Worksheet 4999 could be confusing. Section II of the proposed worksheet analyzed the design of the “stabilizing brace” device separately from the overall configuration of the firearm. The Department agrees with commenters’ concerns that the question

of whether a shoulder stock design is “known” would be difficult for individuals to answer. Therefore, the design factors—“Not based on a known shoulder stock design”; “Incorporates shoulder stock design feature(s)”; and “Based on a known should stock design”—are not included in the objective design features of a rifle in this rule. For this and other reasons discussed herein, the rule does not adopt the proposed worksheet or the point system. Moreover, the objective design features under the final rule no longer include the effectiveness of the “brace” device in assisting with one-handed firing of the firearm, but instead involve consideration of whether the firearm, as configured with an accessory, component, or other rearward accessory (like a “stabilizing brace”) is designed, made, and intended to be fired from the shoulder, as required by the statutory definition of a rifle. As noted above, ATF is simultaneously publishing information with this rulemaking that will inform the public of (1) commonly sold pistol weapon platforms with attached “stabilizing brace” designs and (2) examples of commercially available firearms equipped with a “stabilizing brace” that are short-barreled rifles. Additionally, an individual may contact ATF to receive a determination whether their firearm equipped with a “stabilizing brace” is a rifle as defined by the GCA and NFA.

#### vi. Rear Surface Area

##### Comments Received

Commenters pointed out that one problem with the NPRM’s criterion related to “rear surface area”—*i.e.*, “Device incorporates features to prevent use as a shouldering device,” “Minimized Rear Surface lacking features to discourage shouldering,” “Rear Surface useful for shouldering the firearm,” and “Material added to increase Rear Surface for shouldering”—is that ATF provided no metric for quantifying the surface area. They felt that ATF had not provided adequate information regarding what amount of material is “minimal” or “added” for consideration of whether the rear surface area is useful for shouldering. A commenter argued that ATF failed to provide a reasonable explanation for its determination that the SB Tactical SBA3 device has material added to the rear surface area. The commenter asserted that the criterion seemed subjective and would not assist the public or industry to determine if a firearm is “designed or intended to be fired from the shoulder”



without actual metrics. The commenter also stated that it was unclear what “feature” a “stabilizing brace” could incorporate to make it “difficult” to use as a shouldering device—particularly given that a “stabilizing brace”-equipped firearm that “could possibly be shouldered” would accrue one point under Worksheet 4999. According to the commenter, with no specific metrics, use of words like “possibly,” “sufficient,” and “clearly designed,” as used in the NPRM when discussing this feature, rendered any determination completely subjective.

#### Department Response

After considering the comments, the Department agrees that many of the criteria listed on Worksheet 4999 were open to subjective interpretation and

application. For example, the Department agrees that the NPRM did not provide adequate information to define the meaning of “minimal” or “added” material with respect to the rear surface area of a “stabilizing brace.” Specifically, the Department did not provide a particular metric to quantify the rear surface area to indicate when the firearm would accrue the number of points assigned. For example, the criteria “Minimized Rear Surface lacking features for discourage shouldering,” “Rear Surface useful for shouldering the firearm,” and “Material added to increase Rear Surface Area” were insufficiently clear when used in the NPRM or worksheet to describe the rear surface area of the “stabilizing brace.” Therefore, as previously discussed, the Department is not

adopting Worksheet 4999 or its point values for this rule.

Nevertheless, because both the GCA and NFA define a “rifle” as a weapon designed, made, and intended to be fired from the shoulder, surface area remains a relevant consideration because having a rear surface area is necessary to shoulder a weapon. Therefore, the Department has concluded that any surface area provided by an accessory, component, or other rearward attachment (*e.g.*, a “stabilizing brace”) must be considered prior to the other listed objective design features in this rule. In a rifle configuration, a rear surface area is often provided by a “stock,” “shoulder stock,” or “butt stock,” as demonstrated below:

**BILLING CODE 4410-FY-P**

**FIGURE 1 — COLT® SPORTER RIFLE**

**CAUTION: USE ONLY CLEAN, DRY, ORIGINAL HIGH QUALITY COMMERCIALY MANUFACTURED AMMUNITION IN GOOD CONDITION which is appropriate to the caliber of your firearm. We do not recommend the use of remanufactured or hand loaded ammunition because it may severely damage your rifle.**

SPORTER CHAMBERED FOR:	SUITABLE AMMUNITION				
	223 Rem	222 Rem	222 Rem Mag.	9mm Luger	7.62x39
223 Rem	Yes	No	No	No	No
222 Rem	No	Yes	No	No	No
9mm Luger	No	No	No	Yes	No
7.62x39	No	No	No	No	Yes

Parts of the “Colt Sporter Rifle” in the Colt Safety and Instruction Manual<sup>107</sup>

**FIGURE 1 — COLT® AR-15® Government Carbine (Rifles are longer and have fixed buttstock)**

**CAUTION: USE ONLY CLEAN, DRY, ORIGINAL HIGH QUALITY COMMERCIALY MANUFACTURED AMMUNITION IN GOOD CONDITION which is appropriate to the caliber of your firearm. We do not recommend the use of remanufactured or hand loaded ammunition because it may severely damage your rifle.**

CARBINE CHAMBERED FOR:	SUITABLE AMMUNITION				
	223 Rem	222 Rem	222 Rem Mag.	9mm Luger	7.62x39mm
223 Rem	Yes	No	No	No	No
9mm Luger	No	No	No	Yes	No
7.62x39mm	No	No	No	No	Yes

Parts of the “Colt AR-15 Semiautomatic Rifles and Carbines” in the Colt Safety and Instruction Manual<sup>108</sup>

<sup>107</sup> Colt’s Manufacturing Company, Inc., *Colt Safety and Instruction Manual: Colt Sporter Rifles* (1993), <https://s3.us-east-2.amazonaws.com/>

[media.connecteddatasolutions.com/downloads/sporter+rifles.pdf](https://media.connecteddatasolutions.com/downloads/sporter+rifles.pdf).

<sup>108</sup> Colt’s Manufacturing Company, Inc., *Colt Safety and Instruction Manual: Colt AR-15*

*Semiautomatic Rifles* (1995), [https://s3.us-east-2.amazonaws.com/media.connecteddatasolutions.com/downloads/ar-15\\_semiautomatic\\_rifle\\_%26\\_carbine.pdf](https://s3.us-east-2.amazonaws.com/media.connecteddatasolutions.com/downloads/ar-15_semiautomatic_rifle_%26_carbine.pdf).

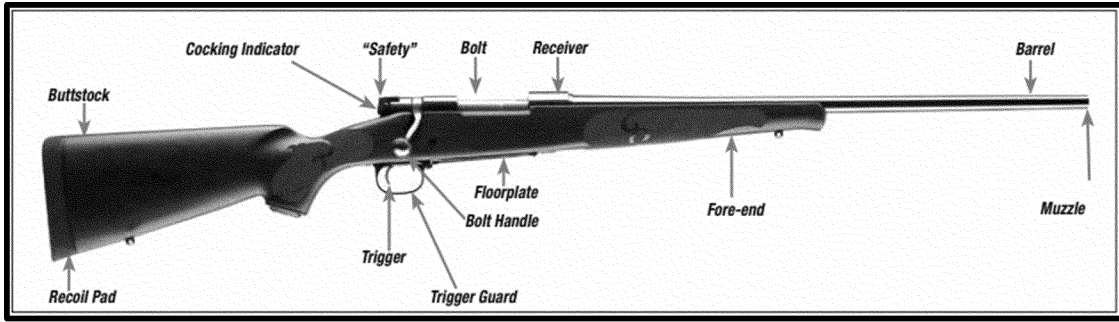

Parts of the "Winchester Model 70 Bolt-Action Rifle" in the Winchester Owner's Manual<sup>109</sup>

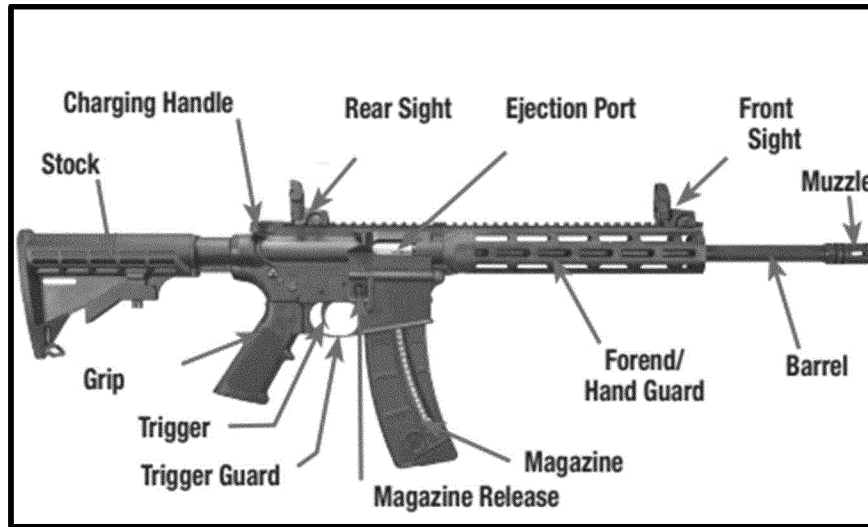

Parts of the "M&P 15-22 Rifle" in the Smith & Wesson Safety and Instruction Manual<sup>110</sup>

<sup>109</sup> Winchester Repeating Arms, *Winchester Model 70 Bolt-Action Rifle Owner's Manual* 9 <https://www.winchesterguns.com/content/dam/winchester-repeating-arms/support/owners->

[manuals/2021/20-WRA-338\\_Model%2070\\_OM\\_WEB.pdf](https://www.winchesterguns.com/content/dam/winchester-repeating-arms/support/owners-manuals/2021/20-WRA-338_Model%2070_OM_WEB.pdf) (last visited Dec. 12, 2022).

<sup>110</sup> Smith & Wesson, *Safety & Instruction Manual M&P 15-22 Rifle* 12 (2019), <https://www.smith->

[wesson.com/sites/default/files/owners-manuals/M%26P\\_1522\\_Rifle\\_111519\\_3005746.pdf](https://www.wesson.com/sites/default/files/owners-manuals/M%26P_1522_Rifle_111519_3005746.pdf).



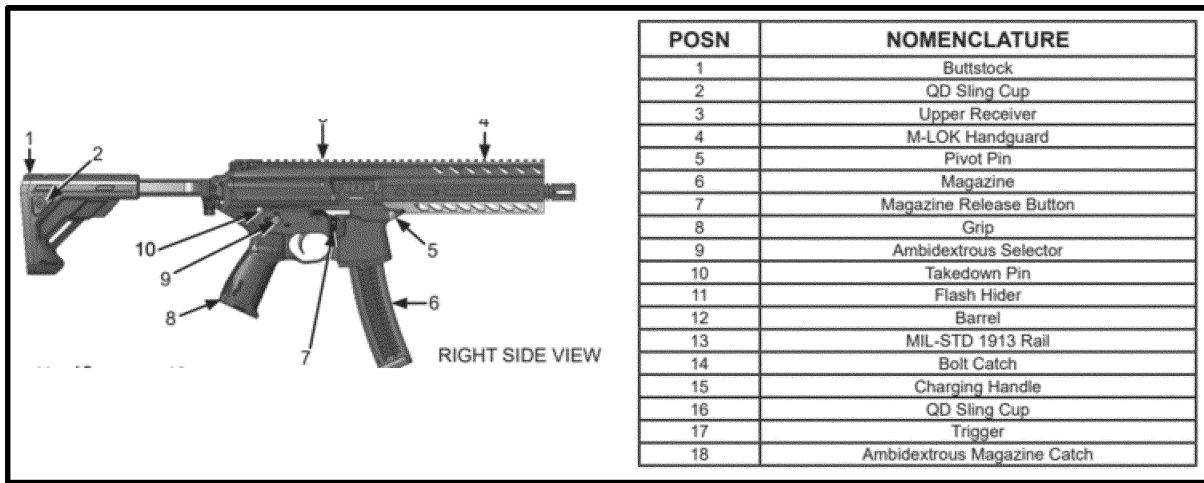

Parts of the “SIG MPX” in the Sig Sauer Operator’s Manual<sup>111</sup>

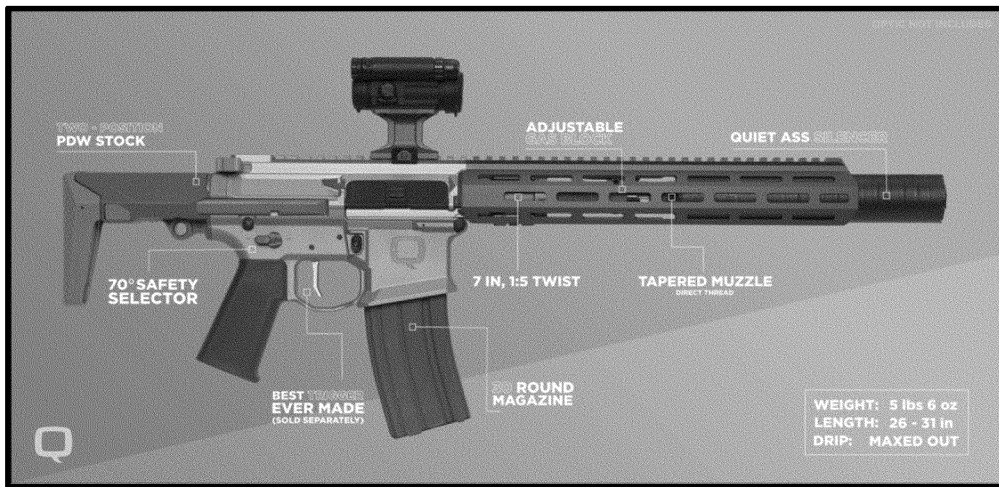

Parts of the Q “Honey Badger SD Short-Barrel Rifle with Silencer”<sup>112</sup>

<sup>111</sup> Sig Sauer Inc., *Sig MPX Operator’s Manual: Handling & Safety Instructions* 26–27 <https://>

[www.sigsauer.com/media/sigsauer/resources/operators-manual-mpx-1811295-01-rev03-lr.pdf](https://www.sigsauer.com/media/sigsauer/resources/operators-manual-mpx-1811295-01-rev03-lr.pdf) (last visited Dec. 12, 2022).

<sup>112</sup> Live Q or Die, LLC., *Honey Badger SD*, [liveqordie.com](https://liveqordie.com), <https://liveqordie.com/honey-badger-sd/> (last visited Dec. 12, 2022).

Recently, many heavy pistols, and some rifle variants, have been manufactured or made in combination

with “stabilizing braces” (rather than a shoulder stock) to create a surface area

on the rear of the weapon with the attached “brace” device.

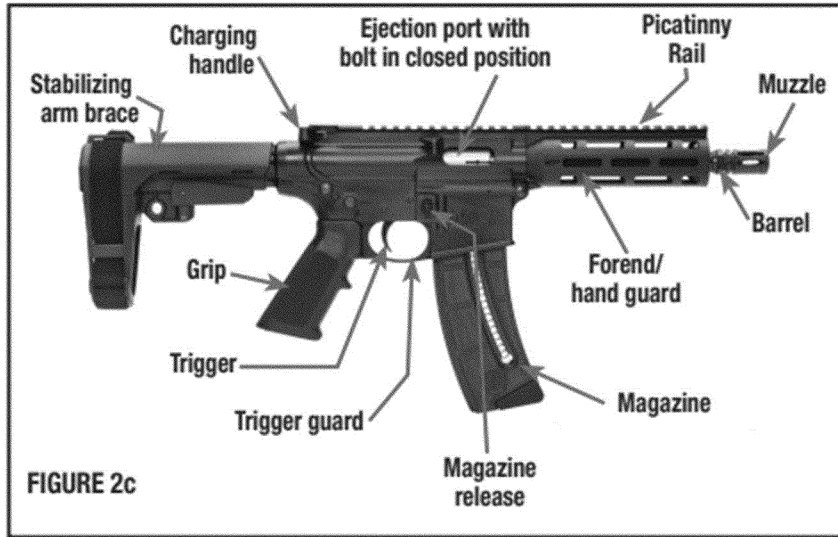

Parts of the “M&P 15-22 Pistol” in the Smith & Wesson Safety and Instruction Manual<sup>113</sup>

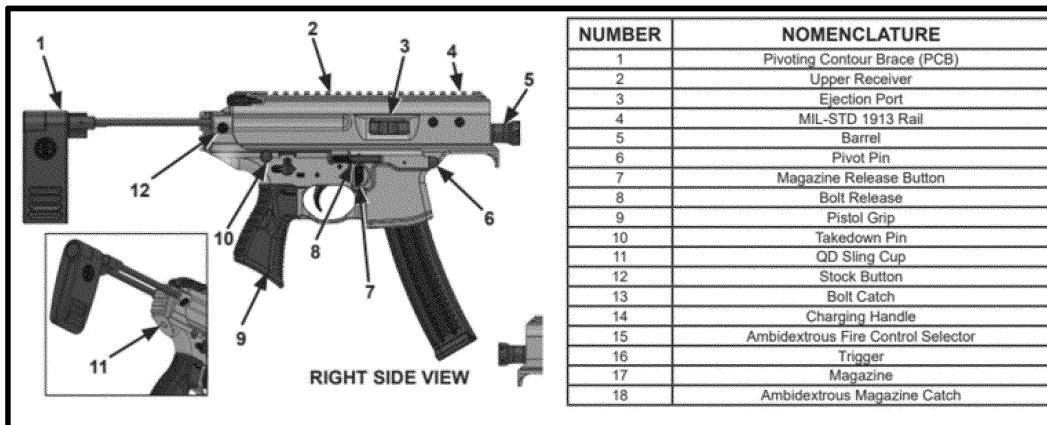

Parts of the “SIG MPX Copperhead” in the Sig Sauer Operator’s Manual<sup>114</sup>

<sup>113</sup> Smith & Wesson Inc., *Safety & Instruction Manual M&P 15-22 Pistol 12* (2020), <https://www.smith-wesson.com/sites/default/files/>

[owners-manuals/M\\_P1522\\_Pistol\\_Manual\\_101520\\_3013615\\_web.pdf](https://www.smith-wesson.com/sites/default/files/owners-manuals/M_P1522_Pistol_Manual_101520_3013615_web.pdf).

<sup>114</sup> Sig Sauer Inc., *SIG MPX Copperhead Operator’s Manual: Handling & Safety Instructions*

26–27, [https://www.sigsauer.com/media/sigsauer/resources/OPERATORS\\_MANUAL\\_MPX\\_COPPERHEAD\\_1811291-01\\_REV02\\_LR.pdf](https://www.sigsauer.com/media/sigsauer/resources/OPERATORS_MANUAL_MPX_COPPERHEAD_1811291-01_REV02_LR.pdf) (last visited Dec. 12, 2022).

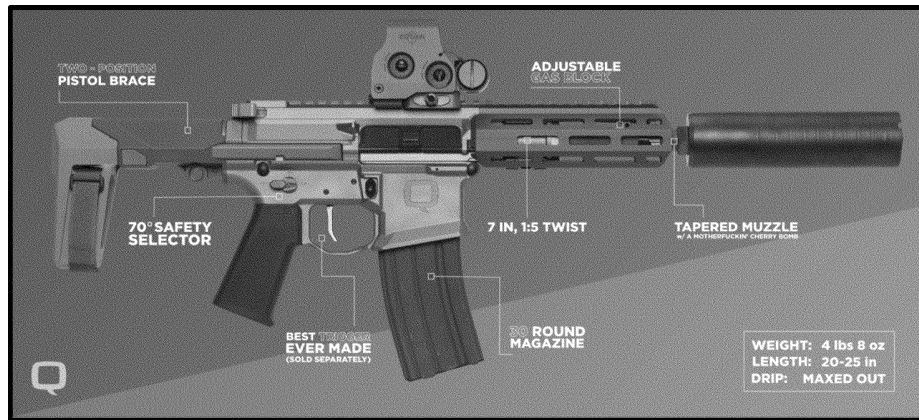

Parts of the “Q Honey Badger Pistol”<sup>115</sup>

Notably, the definition of rifle does not include the term “stock,” nor does it include the term “stabilizing brace.” However, a “stabilizing brace” device may—like a shoulder stock on a rifle—provide surface area for a firearm that

allows shouldering of the weapon, and, therefore, the inclusion of such rear surface area reflects an objective intent that the device is to be fired from the shoulder. For example, a review of the “SIG MPX Copperhead” in *Ballistic*

Magazine demonstrated how the surface area of a “stabilizing brace” may be used to shoulder the weapon. The Department notes that this firearm is marketed as a pistol.



*Ballistic Magazine* provides an example of the use of the rear surface of a “stabilizing brace” for shouldering the firearm.<sup>116</sup>

As previously discussed, the appropriate inquiry is whether the firearm, as configured, is designed, made, and intended to be fired from the shoulder. For example, the

manufacturer of the above referenced “SIG MPX Copperhead” listed the “stabilizing brace,” the pivoting contour brace, as the “stock” type. This terminology demonstrates that the

manufacturer recognizes the similar functions of a traditional shoulder stock and this “stabilizing brace.”

<sup>115</sup> Live Q or Die LLC., *Honey Badger Pistol*, liveqordie.com, <https://liveqordie.com/honey-badger-pistol/> (last visited Dec. 12, 2022).

<sup>116</sup> Greg Lickenbrock, *SIG Copperhead: First Look at the Ultra Compact SIG Sauer MPX 9mm*, *Ballistic Magazine* (Oct. 16, 2019), [https://](https://www.ballisticmag.com/sig-sauer-mpx-copperhead-first-look/)

[www.ballisticmag.com/sig-sauer-mpx-copperhead-first-look/](https://www.ballisticmag.com/sig-sauer-mpx-copperhead-first-look/).



AVAILABILITY	BUY NOW	BUY NOW	BUY NOW
SKU	PMFX-3B-CH-CO	PMFX-3B-CH	PMFX-4B-CH
CALIBER	9mm Luger	9mm Luger	9mm Luger
BARREL LENGTH	3.5 in [89 mm]	3.5 in [89 mm]	4.5 in [114 mm]
MAGS INCLUDED	[1] 10rd Polymer Mag	[1] 20rd Polymer Mag	[1] 20rd Polymer Mag
MAG TYPE	MPX	MPX	MPX
STATE COMPLIANT	CO		
ACTION TYPE	Semi-Auto	Semi-Auto	Semi-Auto
STOCK TYPE	PCB	PCB	PCB
BARREL MATERIAL	Carbon Steel	Carbon Steel	Carbon Steel
TRIGGER TYPE	Single Stage Polished/Hard-Coat	Single Stage Polished/Hard-Coat	TIMNEY Single Stage
TWIST RATE	1:10	1:10	1:10
FOREND TYPE	Alloy	Alloy	Alloy
GRIP TYPE	Polymer	Polymer	Polymer
RECEIVER FINISH	Cerakote	Cerakote	Black Anodized
OVERALL LENGTH	14.5 in [368 mm]	14.5 in [368 mm]	16.5 in [419 mm]
OVERALL WIDTH	2.4 in [61 mm]	2.4 in [61 mm]	2.4 in [61 mm]
HEIGHT	8 in [203 mm]	8 in [203 mm]	8 in [203 mm]
THREADS	N/A	N/A	N/A
ACCESSORY RAIL	M1913	M1913	M1913
OPERATING SYSTEM	Gas Piston	Gas Piston	Gas Piston
WEIGHT	4.5 lb [2 kg]	4.5 lb [2 kg]	4.5 lb [2 kg]

Comparison of “SIG MPX Copperhead” pistol models<sup>117</sup>

For further comparison, below are images showing shoulder stocks next to

“stabilizing brace” devices. Each image shows that the stock and a “stabilizing

brace” device both provide surface area to shoulder the firearm.

<sup>117</sup> Sig Sauer Inc., *SIG MPX Copperhead* (Apr. 24, 2022), <https://web.archive.org/web/>

[20220424154840/https://www.sigsauer.com/sig-mpx-copperhead.html](https://www.sigsauer.com/sig-mpx-copperhead.html).

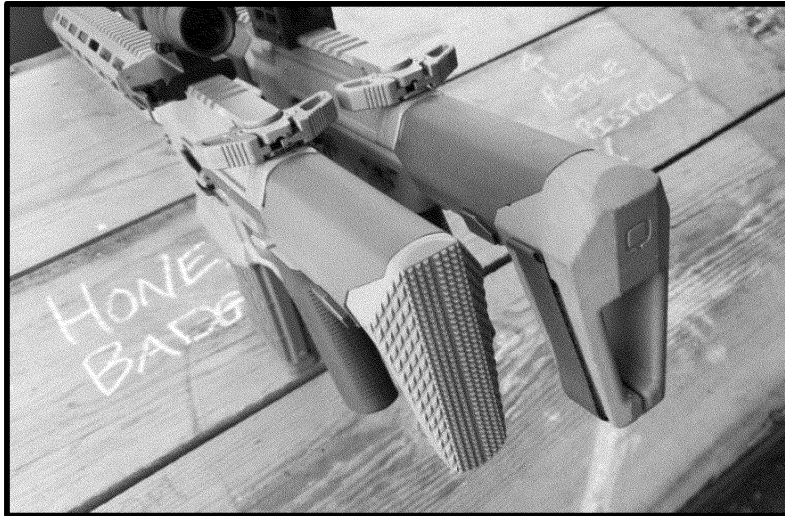

The Q Honey Badger Rifle with a stock (left) and the Q Honey Badger Pistol with a “stabilizing brace” (right)<sup>118</sup>

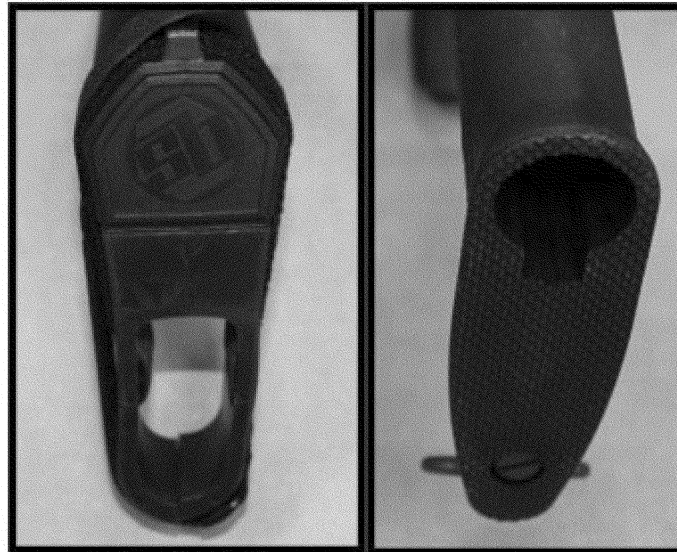

Surface area of SBA3 “stabilizing brace” (left) compared to known AR-15 stock (right)

The Department does not believe it is appropriate or necessary to specify a quantifiable metric for what constitutes surface area that allows for shouldering of the weapon. Under the final rule, any device or extension on the rear of the firearm that provides any surface area that allows for shouldering of the weapon is to be considered first before considering other objective design features. In making this determination, ATF will not attempt to precisely measure or quantify the surface area or

make the determination based on the existence of any minimum surface area. Instead, ATF will consider whether there is any surface area on the firearm that can be used to shoulder fire the weapon. As described, this feature of the weapon will be considered in conjunction with other objective design features, including whether this surface area is necessary for the cycle of operations of the firearm.

The Department acknowledges that a majority of firearms equipped with a “stabilizing brace” have surface area that allows a user to shoulder fire the weapon, but this does not mean that all such weapons would be classified as

“rifles.” Rather, if the weapon has such a surface area, then the weapon would be examined to determine if other factors listed in the rule —*e.g.*, sights or a scope with eye relief that require shouldering of the firearm or length of pull consistent with rifles—indicate that the firearm is designed, made, and intended to be fired from the shoulder. In addition, it is possible for a firearm with an attached rearward device to be designed without including a surface area that allows shouldering. For example, an elastic strap that wraps around the shooter’s wrist and buffer tube on an AR-type firearm is an

<sup>118</sup> Jeremy S., *Gun Review: Honey Badger by Q (SBR and Pistol)*, The Truth About Guns (Jan. 3, 2019), <https://www.thetruthaboutguns.com/gun-review-honey-badger-by-q-sbr-and-pistol/>.



attachment that does not provide surface area to shoulder fire a weapon.

Next, the Department agrees that the NPRM did not articulate what features would prevent the shouldering of a “stabilizing brace.” In contrast to surface area that allows the firearm to be fired from the shoulder, as exemplified in the firearms pictured above, a weapon may include a feature intended specifically to prevent shooting the firearm from the shoulder. The Department therefore clarifies that a firearm is not designed, made, and intended to be fired from the shoulder if the firearm includes a design feature that prevents shouldering. A potential example of such a feature is a permanently attached protrusion that would dig into a shooter’s shoulder should the firearm be fired from the shoulder.

#### vii. Adjustability

##### Comments Received

A majority of the commenters disagreed with the NPRM’s characterization of the “adjustability” factor for “stabilizing braces” and the associated points. One commenter disagreed with ATF’s assessment of adjustability in Section II, noting that it was limited to two entries in Section II—one is “[n]ot adjustable, fixed design,” and one for “[a]djustable or telescoping attachment designed for shouldering.” The commenter stated that these two entries under “Adjustability” indicated that these were the only two possibilities, which the commenter asserted was misleading because there was actually a third possibility: adjustable or telescoping, but not for shouldering.

Similarly, other commenters stated that the proposed rule’s wording presumed that an adjustable or telescoping brace was designed for

shouldering when in fact adjustability, in their opinion, does not itself facilitate shouldering. Other commenters argued that ATF should not give a telescoping attachment two points because braces adjust for varying arm lengths and do not necessarily correlate with shouldering the “stabilizing brace.” Many commenters wrote of their different statures—tall or petite—as the reason they needed the “stabilizing brace” to be adjustable so that they had better support when shooting the firearm. Another commenter stated, “[g]iven the wide variety of forearm circumferences, adjustability is a must” because “[t]o operate effectively, a cuff-type stabilizing brace must fit snugly over the shooter’s forearm.” One commenter observed that the NPRM acknowledged that, when it comes to rifle stocks, generally, taller shooters require a longer length of pull and shorter shooters require a shorter length of pull, but stated that the NPRM failed to make a similar recognition when it comes to users of stabilizing braces because the NPRM asserted that less variation exists between shooters when a pistol is involved because a shooter merely requires a device that reaches from the back of the firearm to the forearm.

Ruger argued that adjustability is doubly penalized because it automatically accrues three points under Section II under “Adjustability” for “adjustable or telescoping attachment designed for shouldering” and one point under “Accessory Design” for being identified as a “shoulder stock design feature.” The commenter argued that the fact “[t]hat the same feature is both a minor and a moderate indicator of the same ‘intended use’ aptly demonstrates the arbitrary nature of the factoring criteria.” The commenter argued that a

disqualifying feature should appear in either Section II or Section III, where accrual of four or more points for each section no longer qualifies it as a brace-equipped pistol, but not in both sections.

##### Department Response

The Department agrees with commenters’ concerns regarding the “adjustability” factor for “stabilizing braces” and the associated points on the proposed Worksheet 4999. Specifically, the Department agrees with commenters’ concern regarding the “double penalty” that would result from considering the “stabilizing brace” device’s adjustability in evaluating both the “Adjustability” and the “Accessory Design” factors. The same commenter also expressed concern regarding the same feature receiving different points in the factoring criteria and the arbitrary nature of that assessment. The Department agrees and, as mentioned, does not adopt the adjustability factor as proposed because it primarily focused on evaluating the effectiveness of a “stabilizing brace” device itself rather than the overall configuration of the firearm.

However, the Department disagrees with commenters who stated that adjustability is not an objective design feature indicating a firearm is designed, made, and intended to be fired from the shoulder. The adjustability of an attachment that uses a rifle receiver extension with the ability to lock in various positions provides fixed horizontal support. Horizontal support means that an individual can place pressure on the rear of the device when firing the weapon without the device or attachment sliding forward. This feature is common with adjustable shoulder stocks.



**The use of a rifle receiver extension provides *horizontal support* for use as a shouldering device.**



The examples below illustrate buffer tubes with adjustment notches that allow a device to lock into place. The ability to lock any device into various positions on the rear of the firearm provides horizontal support, as described above, and allows the device to move rearward toward the shooter to adjust the length of pull to shoulder the weapon.<sup>119</sup> Therefore, an adjustable or telescoping attachment that extends

rearward toward a shooter and has the ability to lock into various positions is an important objective design feature to consider because it provides horizontal support and allows length of pull to be adjusted. Adjustability in the context of length of pull allows the shooter to exercise better control, achieve better accuracy, and better maintain comfort when shooting based on the shooter's body or shooting preferences. For these

reasons, in the final rule, when a firearm equipped with a "brace" device has surface area that allows the firearm to be shoulder fired, it is appropriate to also examine adjustability when considering the length of pull of the firearm, discussed below, to determine if the firearm is designed, made, and intended to be fired from the shoulder.

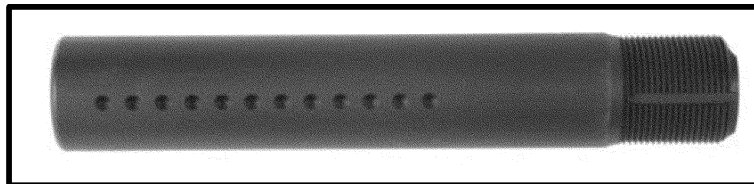

**AR-type Pistol Buffer Tube (KAK tube) with Adjustment Notches**

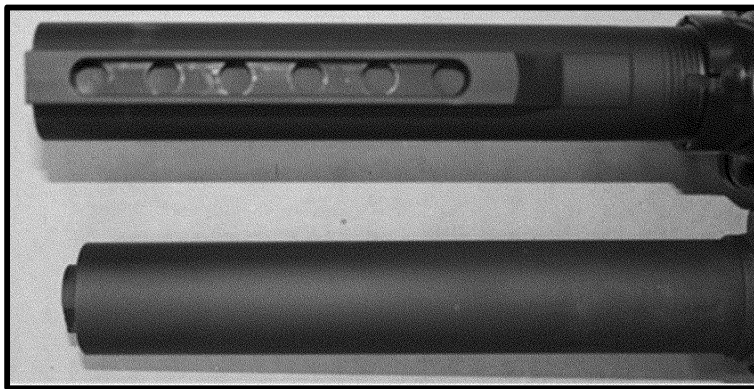

**Adjustable Rifle Buffer Tube (top) compared to a Standard Pistol Receiver Extension (bottom)**

#### BILLING CODE 4410-FY-C

The Department also disagrees with commenters that said it must consider the variations among shooters, including different forearm circumference, arm length, and height, in weighing the adjustability factor. As previously discussed, beginning in 2012, ATF misinterpreted the statutory definition of rifle because it improperly relied on the purported intent of "stabilizing brace" device manufacturers and users and incorrectly concluded that, if the firearm can be fired with one hand using a "stabilizing brace," then it cannot be designed,

made, and intended to be fired from the shoulder. While ATF may consider the purported intent or use of the device, the best interpretation of the statute calls for an assessment of whether the maker or manufacturer's stated intent is consistent with the objective design features of overall configuration of the weapon; this interpretation ensures that purported intent or use cannot be easily used to circumvent the NFA's requirements. A firearm's classification does not change even if the firearm can be used in more than one manner by a particular shooter. Thus, the final regulatory text incorporates in the

definition of "rifle" an adjustable or telescoping attachment with the ability to lock into various positions along the buffer tube or other attachment method as an objective design feature to be considered when examining length of pull on a firearm that has a surface area that allows the weapon to be fired from the shoulder.

#### viii. Stabilizing Brace Support Comments Received

Commenters raised questions about Section II of Worksheet 4999 regarding evaluation of "Stabilizing Support." One commenter stated that assigning

<sup>119</sup> See Wing Tactical, *Fixed vs. Adjustable Stocks* (Sept. 11, 2015), <https://www.wingtactical.com/blog/fixed-vs-adjustable-stocks/> ("AR-15 Adjustable Stock—Keep this in mind: A fixed stock can't get any shorter. But a collapsible or adjustable stock can almost always get longer . . . . [A]djustable stocks are perfect for shooters who don't always fit the 'average joe' arm length, because they can always adjust to the proper length-of-pull. What's more, these kinds of stocks are also

helpful when you're shooting in groups with people taking turns on the same rifle. It's important to remember that adjustable stocks might not be as durable as the more rigid fixed stocks." (emphasis omitted)); Magpul, PRS® GEN3 Precision-Adjustable Stock, [https://magpul.com/firearm-accessories/stocks/ar15-m4-m16-sr25-m110-ar10/prs-gen3-precision-adjustable-stock.html?mp\\_global\\_color=118](https://magpul.com/firearm-accessories/stocks/ar15-m4-m16-sr25-m110-ar10/prs-gen3-precision-adjustable-stock.html?mp_global_color=118) (last visited Dec. 12, 2022) ("The PRS GEN3 is a field precision stock for AR15/M16

and AR10/SR25 platforms, featuring tool-less length of pull and cheek piece height adjustment. With solid adjustments for length of pull and cheek piece height via aluminum detent knobs, the PRS GEN3 (Precision Rifle/Sniper) stock provides a stable interface and is intended for semi-automatic sniper or varmint type rifles. Offering a nearly universal fit, it is optimized for rifle-length receiver extensions but will also mount to many mil-spec carbine and A5-length tubes[.]").

points based upon ATF's assessment of whether a "stabilizing brace" is "effective" as a brace was misguided because, although an effective brace might provide some indication of whether a weapon is or is not to be shouldered, ATF has no grounds for assuming that an ineffective or a poorly functioning "brace" indicates that a weapon is intended to be fired from the shoulder, is useful for shouldering, or was created to circumvent the NFA. The same commenter stated that the ATF should provide specific metrics (*e.g.*, a specific number of inches) to determine when a "fin-type" design has an arm strap of suitable length or when a "cuff-type" design is capable of "fully" wrapping around the arm.

Similarly, with regard to "cuff-type" designs, a few commenters faulted ATF for assigning in the NPRM different numbers of points to the SB Mini and SBA3 "stabilizing brace" devices based on whether they "partially" wrapped around a shooter's arm even though, according to the commenters, the two devices utilize similar arm cuff sizes. The commenters asserted that because "partially" means "to some extent," they did not understand why the SB Mini "partially" wraps around the forearm but the SBA3 does not. The difference in point accumulation and how to apply the standard to different brace models was unclear because how much of the shooter's forearm is encircled would depend on the shooter.

Similarly, another commenter believed that ATF confused "stabilizing support" regarding the "cuff-type" braces. The commenter asserted that this criterion was "completely subjective and will vary significantly

from person to person," asking "how can this be an objective, measurable standard? A brace that may fully wrap around a small person's arm may not wrap around the arm of a bodybuilder, for example." The commenter also asked, "why is a cuff- or fin-type design with a strap made of elastic material more like a stock than one without elastic material?" Another commenter stated it was unclear for cuff-type "stabilizing braces" how much of the cuff must engage the arm for it to "partially wrap around the shooter's forearm."

The same commenter critiqued ATF's approach to examining "braces" with a counterbalance design, stating that the "folding feature" makes good sense because it allows the counterbalance arm to be streamlined for ease of carry.

#### Department Response

The Department agrees with commenters' concerns regarding the assessment of points on Worksheet 4999 for "cuff-type" brace device designs that "partially" or "fail" to wrap around the arm. Specifically, the Department agrees that terms like "partially" and "fail" were not sufficiently defined and that it would be difficult to make a uniform determination on whether a "cuff-type" brace partially or fails to wrap around a particular shooter's arm. In the NPRM, the Department explained that stabilizing support is a vital characteristic to consider in determining a firearm's classification because it provides evidence of the purported purpose of the attached device. However, the Department re-evaluated this position and determined that an analysis of whether the "brace" device provides stabilizing support for single-

handed fire is distinct from whether a firearm, as configured with the "brace" device, is designed, made, and intended to be fired from the shoulder. While the purported intent of the device manufacturers may be considered, the way the "brace" device is or can be used is not determinative as to whether the firearm is designed and intended to be fired from the shoulder. Therefore, stabilizing support is not a relevant objective design feature and therefore is not incorporated into this rule.

Although stabilizing support is not adopted as an objective design feature, the Department responds to commenters who opined that a folding counterbalance design<sup>120</sup> makes good sense for ease of carry. While the folding design may make the firearm easier to carry, the Department disagrees with the notion that this purpose would indicate the firearm is not designed and intended to be fired from the shoulder. A counterbalance design includes a folding feature that provides a rear surface area on the "stabilizing brace" when closed (or folded), as demonstrated below. As previously discussed, a surface area that allows shouldering of the weapon remains an objective design feature that a firearm is designed, made, and intended to be fired from the shoulder.

#### BILLING CODE 4410-FY-P

<sup>120</sup> A counterbalance design is a design that uses the weight of the firearm as a lever to push the "stabilizing brace" into the forearm to provide stability during single-handed firing. This design does not typically include straps because the "stabilizing brace" contacts the side and bottom of the shooter's arm and is held in place by the weight of the firearm, using the shooter's hand as a fulcrum. *See, e.g.*, US Patent 10,690, 442 B2 Dec. 6, 2018.

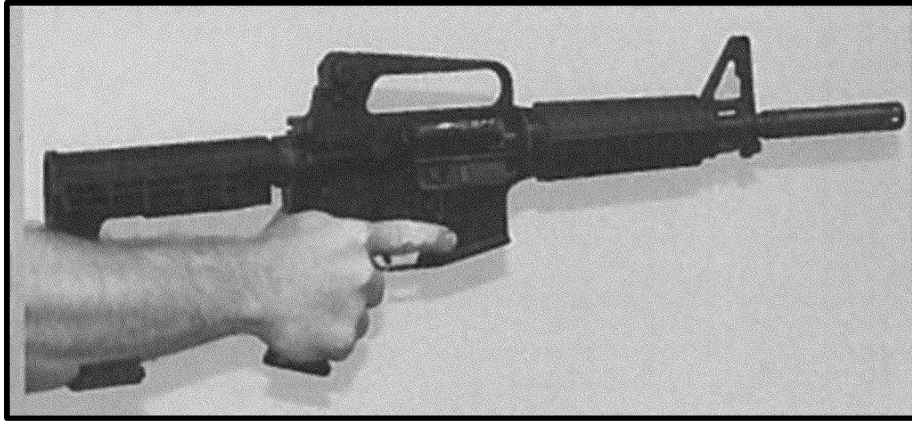

**Counterbalance-type device**

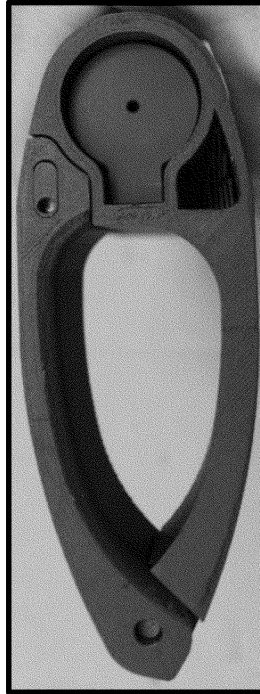

**Rear of counterbalance-type device when folded**

**BILLING CODE 4410-FY-C**

ix. Length of Pull

Comments Received

Commenters asserted that the proposed length of pull “scale” makes little sense and “discounts the fact that: (1) shooters have different length forearms; (2) shooters may prefer the brace to be mounted to their forearm in different locations; and (3) a brace-equipped pistol’s design and weight balance will necessitate a brace’s varied position on a forearm.” Other commenters further noted that ATF provided no explanation for its “length of pull” ranges, and they asserted that this concept is not found in any statute or regulation, but rather appeared to be a creation of ATF bureaucrats. Another commenter stated that length of pull is

normally associated with “rifles” and shotguns with stocks. Because “braces” are not stocks, the commenter argued that the entire section was invalid from the premise. A comment from the congressional Second Amendment Caucus agreed with other commenters that length of pull concept is “not found in any statutes, nor is it defined in any of the agency’s regulations . . . . ATF opines that ‘[l]ength of pull is a common measurement of firearms that describes the distance between the trigger and the center of the shoulder stock.’ But a ‘firearm’ or ‘pistol’ does not have a stock, even if it uses a stabilizing brace, and ATF fails to explain why it is appropriate to use a rifle measurement when analyzing pistols.” (Citation omitted.)

Commenters also argued that the length of pull measurements were arbitrary and subjective because they were based on having the accessory in the “Rear most ‘Locked Position.’” One of these commenters stated that it was unclear what the term “locked position” meant and also unclear how length of pull would be measured if there was no locked position. The commenter found ATF’s examples confusing and stated that approximate measures from the examples were not useful. Another commenter stated that “length of pull” in the proposed worksheet was ambiguous.

The Gun Owners of America argued that ATF should have described the length of pull based on how a firearm with an attached device is “actually configured,” not how it “theoretically”



could be configured in the rear-most, locked position. “Confusingly, the NPRM appears to admit as much, claiming that a brace ‘will accrue more points the further it is positioned rearward,’ indicating that it should be measured the way it is actually configured.” Another commenter asserted that braces are more effective when they interact with a user’s forearm close to the elbow to provide optimum leverage, and that users with longer forearms should not be penalized by ATF’s length determinations.

One commenter provided a detailed discussion of “length of pull” and “rear surface area.” He suggested that the “Department should change the worksheet into a two-tiered approach. As the first step, ask whether the combination of ‘length of pull’ and ‘rear surface area’ make the braced pistol suitable for firing from the shoulder.” (Emphasis omitted.) The commenter stated that if the answer is “no” then the braced pistol should be approved. On the other hand, if “yes,” then additional features should be considered, and additional points possibly awarded. The commenter suggested that other features need not be considered “unless the length of pull, and rear area surface are suitable for firing from the shoulder.” To reiterate this point, the same commenter stated that, “[o]n the proposed worksheet, the ‘rear surface area’ criterion is independent of the ‘adjustability’ and ‘length of pull’ criteria. This is not appropriate; in the case of these three criteria, each criterion must be examined in the context of the others.” (Citation omitted.) Another commenter stated that, if not removed as a factor, then “length of pull” should be revised so that zero points are assigned to a firearm with a “length of pull” less than 13–1/2 inches, consistent with ATF’s prior findings.

#### Department Response

The Department agrees with commenters that the length of pull “scale” in Worksheet 4999 is confusing but disagrees that the scale must account for length of shooting preferences of different shooters. The Department also disagrees that length of pull is a concept or standard that is ambiguous, subjective, or the creation of ATF. Length of pull is a well-known standard in the firearms industry. SAAMI references length of pull as well as other features when discussing “stock dimensions”<sup>121</sup> and defines length of

pull as “[t]he distance from the center of the trigger to the center of the buttplate or recoil pad.”<sup>122</sup> *The NRA Firearms Sourcebook* also defines “length of pull” as the distance between the center trigger and the center of buttplate or recoil pad the shoulder stock.<sup>123</sup> This standard is also commonly recognized by industry; specifically, firearm manufacturers, such as Ruger, Mossberg, LWRC International, CZ–USA, Browning, and Remington, all reference length of pull in their advertising of firearms or firearms accessories.<sup>124</sup> Therefore, it is reasonable for the Department to consider lengths of pull consistent with rifles as an objective design feature indicating that a firearm is designed to be fired from the shoulder.

The Department disagrees that measuring length of pull in the “rear most” locked position is arbitrary. A length of pull on a rifle appropriately adjusted for the shooter (*i.e.*, size or shooting preferences) allows a shooter to exercise better control, improve accuracy, and maintain comfort when shooting based on the shooter’s body or shooting preferences.<sup>125</sup> For the reasons discussed herein and in section IV.B.3.b.vii of this preamble, whether there is an adjustable or telescoping attachment with the ability to lock into various positions along a buffer tube,

[saami.org/glossary/stock-dimensions/](https://saami.org/glossary/stock-dimensions/) (last visited Dec. 13, 2022).

<sup>122</sup> SAAMI, *Glossary*, Sporting Arms and Ammunition Manufacturers’ Institute, Inc., <https://saami.org/glossary/stock-dimensions/> (last visited Dec. 13, 2022).

<sup>123</sup> Michael E. Bussard and Stanton L. Wormley, Jr., *NRA Firearms Sourcebook* 137 (2006).

<sup>124</sup> Ruger, *Ruger Precision Rifle*, <https://www.ruger.com/products/precisionRifle/specSheets/18084.html> (last visited Dec. 12, 2022); O.F. Mossberg & Sons, Inc., *Mossberg International 817*, <https://www.mossberg.com/mossberg-international-817-38191.html> (last visited Dec. 12, 2022); LWRC International, *LWRCI UCIW Stock Kit*, [https://www.lwrci.com/LWRCI-UCIW-Stock-Kit\\_p\\_38.html](https://www.lwrci.com/LWRCI-UCIW-Stock-Kit_p_38.html) (last visited Dec. 12, 2022); CZ USA, *CZ 1012*, <https://www.cz-usa.com/products/cz-1012/> (last visited Dec. 12, 2022); Browning, *X-Bolt Mountain Pro LR Burnt Bronze Bolt- Action Rifle*, <https://www.browning.com/products/firearms/rifles/x-bolt-mountain-pro-lr.html> (last visited Dec. 22, 2022); Remington, *Model 700 SPS Tactical AAC-SD*, <https://www.remarms.com/rifles/bolt-action/model-700/model-700-sps-tactical-aac-sd> (last visited Dec. 22, 2022).

<sup>125</sup> See Tyler Hughes, *Length of Pull: A Complete Guide for Fitting Your Rifle to Your Body* ([ballisticmag.com](http://ballisticmag.com)), *Ballistic Magazine* (June 24, 2021), <https://www.ballisticmag.com/length-of-pull-guide/>; Suzanne Wiley, *The Shooter’s Log: What is Length of Pull and Why Does It Matter*, *Cheaper Than Dirt* (July 10, 2013), <https://blog.cheaperthandirt.com/length-pull-matter/>; Frankie Chan, *What is Length of Pull on an AR-15?*, *Wing Tactical* (Mar. 9, 2022), <https://www.wingtactical.com/blog/what-is-length-of-pull-on-an-ar15/>; Savage Arms, *Fitment: Why Rifle Fit Matters* (Mar. 5, 2020), <https://savgearms.com/blog/?p=fitment-why-rifle-fit-matters>.

receiver extension, or other attachment method is considered when examining a firearm’s length of pull to determine if the firearm is designed, made, and intended to be fired from the shoulder.

How ATF would measure the length of pull under this rule would depend on the type of “brace” device attached to the weapon. First, for devices with fixed material or a device in a fixed position on the rear of the firearm, the length of pull of a firearm would be measured from the device’s fixed position to the center of the trigger. This is the position by which an individual may shoulder the firearm. Second, for devices that are not fixed and instead have a mechanism to lock into place in various locations along a buffer tube or receiver extension, ATF would measure length of pull with the device in the rearmost locked position. As earlier discussed, the benefit of an adjustable stock, “stabilizing brace,” or other shouldering device that can lock into position along a buffer tube or receiver extension is that it adjusts the length of pull of the firearm and offers horizontal support (*i.e.*, to use against the shoulder) based on shooter’s preferences.<sup>126</sup>

The Department has chosen to use the rearmost locked position for such devices because the Department believes that this measurement will best indicate whether the firearm is designed, made, and intended to be fired from the shoulder. The fact that an adjustable stock, “stabilizing brace,” or other shouldering device might, in certain configurations, be appropriate for firing without shouldering the weapon does not preclude a conclusion that the weapon with the device is still designed, made, and intended to be fired from the shoulder. To the contrary, if the device in the rearmost locked position results in a length of pull that is consistent with shoulder-fired weapons, that length of pull is a design feature that—in combination with other features—could indicate that the weapon is designed, made, and intended to be fired from the shoulder. The possibility for non-shoulder firing with the device in other positions does not preclude this conclusion because, as explained above, the potential alternate uses of a weapon do not eliminate the

<sup>126</sup> See Savage Accuracy, *Understanding Length-of-Pull*, YouTube.com (Oct. 31, 2017), <https://www.youtube.com/watch?v=Ler-d3MDLA0&t=109s>; Vickers Tactical, *BCM Training Tip: Buttstock Length*, YouTube.com (Mar. 30, 2018), <https://www.youtube.com/watch?v=cijL2QYH3l>; Viking Tactics, *Tactical Tip of the Day: Proper Buttstock Length*, YouTube.com (Feb. 8, 2019), <https://www.youtube.com/watch?v=ER-s6pSCxj>; Brownells, Inc., *The Magpul PRS Gen3 AR15/M16 Stock*, YouTube.com (Feb. 26, 2018), <https://www.youtube.com/watch?v=obFCK3g19wI>.

<sup>121</sup> SAAMI, *Glossary*, Sporting Arms and Ammunition Manufacturers’ Institute, Inc., <https://saami.org/glossary/stock-dimensions/>.

likelihood that the weapon—in addition to these alternate uses—is designed, made, and intended for shoulder firing. ATF accordingly will examine length of pull with the device in the rearmost position to determine whether shoulder firing is the designed and intended use, even if the device in other positions might not be amenable to such firing.

Therefore, it is appropriate for ATF to consider the longest possible length of pull on a device that can adjust and lock into place along a buffer tube or receiver extension.

Finally, for a firearm that includes a device that is movable but cannot be affixed into various positions along the buffer tube or receiver extension, length

of pull would be measured with the device collapsed. This is because the device would collapse toward the receiver of the firearm if a shooter were to press his or her shoulder against it. The chart below summarizes these three methods of measuring length of pull depending on the type of stock or other device used to shoulder the firearm.

Fixed non-adjustable stock, “stabilizing brace,” or other device .....	Measure the distance between the center of the trigger and the rear center of the device in the fixed position.
Adjustable stock, “stabilizing brace,” or other device with the ability to lock into various positions along the buffer tube or other attachment method.	Measure the distance between the center of the trigger and the rear center of the device in the rearmost locked position.
A stock, “stabilizing brace,” or other device that is movable but cannot be in a fixed position or made stationary along the buffer tube.	Measure the distance between the center of the trigger and the rear center of the device with the device collapsed.

Like the industry, FATD measures the length of pull from the center of the trigger to the rear center of the stock, “stabilizing brace,” or other shouldering device. FATD previously determined the standards for length of pull by a review of industry publications and by measuring the length of pull of various rifles.<sup>127</sup> FATD determined the average “length of pull” is between 13½ and 14½ inches for rifles. ATF’s own analysis is consistent with the *NRA Firearms Sourcebook*, which also provides that the average length of pull

found on shoulder-fired weapons is approximately 13½ to 14½ inches.<sup>128</sup> However, many more modern and common rifles are equipped with shouldering devices that result in shorter length-of-pull-measurements. For example, AK-types usually have a length of pull between 12½ to 13½ inches. For those firearms that are a variant of a rifle,<sup>129</sup> ATF would compare the length of pull between a firearm with a “stabilizing brace” or other attached device against that rifle configuration. For example, the length

of pull of an AK-type pistol equipped with a “stabilizing brace,” which has a length of pull of over 12½ inches, would be compared to AK-type rifles. Similarly, a Glock-type pistol with a “stabilizing brace” would be compared to a Glock-type pistol equipped with a stock.

FATD measured the length of pull of various rifles from the National Firearms Collection as displayed in the chart below.

Manufacturer	Model	Caliber	LOP
COLT .....	SMG .....	9x19mm .....	13”
COLT .....	AR-15 .....	.223 REM .....	13”
Q .....	HONEY BADGER .....	.300 BLK .....	13”
LWRC .....	M6 .....	.223 REM .....	137/8”
SIG SAUER .....	MCX .....	.223 REM .....	131/4”
SIG SAUER .....	MCX RATTLER .....	.300 BLK .....	121/4”
MAXIM DEFENSE .....	MDX .....	.223 REM .....	117/8”
MAXIM DEFENSE .....	PDX .....	.223 REM .....	12”
LRB ARMS .....	M15SA .....	.223 REM .....	13”
BCI DEFENSE .....	SQS15 .....	.223 REM .....	113/4”
H&K .....	MK16 .....	.223 REM .....	14”
Z-M WEAPONS .....	LR300 .....	.223 REM .....	137/8”
OLYMPIC ARMS .....	M.F.R. ....	.223 REM .....	15”
ARSENAL .....	AKS-74U .....	.223 REM .....	131/2”
ARSENAL .....	SAS M-7 .....	7.62x39mm .....	13”
YUGOSLAVIA .....	AK-47 .....	7.62x39mm .....	123/4”
ZASTAVA .....	AK-47 .....	7.62x39mm .....	131/4”
IRAQ .....	TABUK .....	7.62x39mm .....	127/8”
RUSSIAN .....	KRINK .....	7.62x39mm .....	125/8”
MAGUA INDUSTRIES .....	MINI-BERYL .....	.223 REM .....	121/4”
H&K .....	MP5K .....	9x19mm .....	125/8”
H&K .....	MP5 .....	9x19mm .....	13”
H&K .....	UMP .....	.45 ACP .....	145/8”
BOBCAT WEAPONS .....	BW-5 .....	9x19mm .....	133/4”
HK .....	USC .....	.45 ACP .....	141/4”
S.W.D. ....	CM-11 .....	9x19mm .....	14”
S.W.D. ....	M-11/NINE .....	9x19mm .....	167/8”
M.A.C. ....	M10 .....	.45 ACP .....	137/8”
MAC PMF .....	M11 .....	.380 ACP .....	131/4”
JERSEY ARMS .....	AVENGER .....	.45 ACP .....	161/2”
RPB .....	M10 .....	9x19mm .....	161/2”
IMI .....	UZI .....	9x19mm .....	151/2”
IMI .....	MINI UZI .....	9x19mm .....	16”
IMI .....	MICRO UZI .....	9x19mm .....	14”
IMI .....	MICRO UZI .....	9x19mm .....	141/8”

<sup>127</sup> See *supra* notes 121–123 and accompanying discussion.

<sup>128</sup> See *supra* note 123.

<sup>129</sup> See 87 FR at 24693 (discussing variants).

Manufacturer	Model	Caliber	LOP
IWI	UZI PRO	9x19mm	14 <sup>3</sup> / <sub>4</sub> "
LWRC	SMG45	.45 ACP	12 <sup>1</sup> / <sub>2</sub> "
SIG SAUER	MPX	9x19mm	11"
SIG SAUER	MPX	9x19mm	13 <sup>1</sup> / <sub>4</sub> "
SIG SAUER	MPX	9x19mm	12 <sup>1</sup> / <sub>2</sub> "
B&T	APC9	9x19mm	13 <sup>1</sup> / <sub>4</sub> "
B&T	TP9	9x19mm	15 <sup>1</sup> / <sub>2</sub> "
BERETTA	CX4 STORM	9x19mm	13 <sup>3</sup> / <sub>4</sub> "
BERETTA	CX4 STORM	.40 S&W	13 <sup>1</sup> / <sub>4</sub> "
DBX	5.7DBX	5.7x28mm	11"
CZ	EVO SCORPION	9x19mm	14 <sup>1</sup> / <sub>2</sub> "
CZ	EVO SCORPION	9x19mm	14 <sup>1</sup> / <sub>2</sub> "
CZECH	SKORPION	.32 ACP	13 <sup>3</sup> / <sub>4</sub> "
GRAND POWER	STRIBOG SP9A1	9x19mm	13 <sup>1</sup> / <sub>2</sub> "
INTRATEC	MP9	9x19mm	12 <sup>1</sup> / <sub>2</sub> "
INTRATEC	TEC-KG9	9x19mm	13 <sup>1</sup> / <sub>2</sub> "
CALICO	M900	9x19mm	16 <sup>1</sup> / <sub>2</sub> "
RUGER	PC CARBINE	9x19mm	13 <sup>1</sup> / <sub>2</sub> "
RECOVER TACTICAL	PI-X	9x19mm	15 <sup>1</sup> / <sub>4</sub> "
FN	P90	5.7x28mm	13 <sup>3</sup> / <sub>8</sub> "
FN	PS90	5.7x28mm	13 <sup>3</sup> / <sub>8</sub> "
HK	MP7	4.6x30mm	14 <sup>1</sup> / <sub>4</sub> "
KRISS	VECTOR	.45 ACP	12 <sup>1</sup> / <sub>2</sub> "
KRISS	VECTOR	.45 ACP	12 <sup>1</sup> / <sub>2</sub> "
HI-POINT	4095	.40 S&W	14 <sup>5</sup> / <sub>8</sub> "
KEL-TEC	SUB2000	9x19mm	13 <sup>1</sup> / <sub>4</sub> "
STEYR	MP40	9x19mm	12 <sup>1</sup> / <sub>2</sub> "
STEN	MK11	9x19mm	11 <sup>1</sup> / <sub>2</sub> "
FB	MSBS	.223 REM	13 <sup>1</sup> / <sub>4</sub> "
IWI	CARMEL	.223 REM	14 <sup>3</sup> / <sub>4</sub> "
FN	SCAR-16	.223 REM	14 <sup>1</sup> / <sub>4</sub> "
FN	SCAR PDW-P	.223 REM	14 <sup>1</sup> / <sub>2</sub> "
FN	FS2000	.223 REM	14 <sup>3</sup> / <sub>4</sub> "
CZ	BREN 805	.223 REM	13 <sup>1</sup> / <sub>2</sub> "
REMINGTON	700	.308 WIN	13 <sup>1</sup> / <sub>8</sub> "
HK	HK93	.223 REM	13 <sup>3</sup> / <sub>4</sub> "
STEYR	AUG	.223 REM	14 <sup>3</sup> / <sub>4</sub> "
STEYR	AUG	9x19mm	15"
WINCHESTER	1894	.30 W.C.F.	13"
GERMANY	STG44	7.92 KURTZ	14"
RUGER	MINI-14	.223 REM	13 <sup>1</sup> / <sub>3</sub> "
KEL-TEC	SU-16	.223 REM	13 <sup>5</sup> / <sub>8</sub> "
BERETTA	RX4 STORM	.223 REM	13 <sup>1</sup> / <sub>2</sub> "
INLAND	M2 CARBINE	.30 CAL	13 <sup>1</sup> / <sub>8</sub> "
US	M2 CARBINE	.30 CAL	14 <sup>5</sup> / <sub>8</sub> "
BROWNING	BUCKMARK	.22LR	15"
MAUSER	C96	7.63x25mm	16 <sup>1</sup> / <sub>4</sub> "
DWM	LUGER	9x19mm	17 <sup>3</sup> / <sub>4</sub> "
DWM	LUGER	9x19mm	16 <sup>1</sup> / <sub>2</sub> "
MAUSER	C96	.30 Mauser	16 <sup>1</sup> / <sub>8</sub> "
MAUSER	C96	9x19mm	16 <sup>3</sup> / <sub>8</sub> "
GERMANY	STECHKIN	.380 ACP	15 <sup>3</sup> / <sub>4</sub> "
UNITED KINGDOM	MK6	.455 WEB	16 <sup>1</sup> / <sub>4</sub> "
STAR	1911	.38 Super	12 <sup>5</sup> / <sub>8</sub> "
BROWNING/FN	HI-POWER	9x19mm	16 <sup>3</sup> / <sub>8</sub> "
BERETTA	93R	9x19mm	16 <sup>1</sup> / <sub>2</sub> "
CAA	MCK CL	9x19mm	16"
CAA	MCK GEN 2	9x19mm	15 <sup>3</sup> / <sub>4</sub> "
FIRE CONTROL UNIT	X-01	9x19mm	13 <sup>7</sup> / <sub>8</sub> "
RECOVER TACTICAL	20/20N	9x19mm	15"
FAB DEFENSE	KPOS G2	9x19mm	15 <sup>3</sup> / <sub>4</sub> "
ACCURATE PISTOL SYSTEMS	GLOCK 17	9x19mm	17"
ENDO TACTICAL	GLOCK 17	9x19mm	19 <sup>1</sup> / <sub>2</sub> "
TAC STOCK	GLOCK 17	9x19mm	17 <sup>3</sup> / <sub>4</sub> "
CALICO	M-100	.22LR	18 <sup>1</sup> / <sub>4</sub> "
UMAREX	HK 416D	.22LR	14 <sup>5</sup> / <sub>8</sub> "
ISSC	MK22	.22LR	14"
GSG	GSG-522	.22LR	13 <sup>3</sup> / <sub>4</sub> "
DAISY MFG	N/A	.22LR	13 <sup>3</sup> / <sub>8</sub> "
HENRY	LEVER ACTION	.22LR	12 <sup>3</sup> / <sub>4</sub> "
REMINGTON	MODEL 597	.22LR	14"
SPRINGFIELD	M6 SURVIVAL	.22LR	11"
ITHACA	M6 SURVIVAL	.22LR	11 <sup>1</sup> / <sub>2</sub> "
CHARTER ARMS	AR-7	.22LR	15"



Manufacturer	Model	Caliber	LOP
RUGER .....	22-Oct .....	.22LR .....	13½"
KSA .....	CRICKET .....	.22LR .....	11⅞"

The Department disagrees with commenters who stated it is not appropriate to use a rifle measurement when analyzing pistols. The Department has determined that, to best implement the relevant statutes, ATF should not simply assume that a firearm should be classified in accordance with the manufacturer's stated intent. Rather, based on the best reading of the relevant statutory provisions, ATF will examine the firearm for characteristics (e.g., length of pull) consistent with whether a firearm is designed, made, and intended to be fired from the shoulder. The objective design features of the firearm may support or undermine a manufacturer's stated intent regarding whether the firearm is or is not designed, made, and intended to be fired from the shoulder. Therefore, after considering whether the firearm has surface area that allows for shouldering, it is reasonable for the Department to consider length of pull consistent with similar rifles as a design feature indicating that a firearm is designed to be fired from the shoulder.

For similar reasons, the Department disagrees with the commenters that suggested measuring length of pull for weapons with "stabilizing braces" was an invalid concept because the weapons do not have "stocks." Although some measures of length of pull may refer to a "stock," the purported "stabilizing brace" on a firearm is often similar to a shoulder stock in construction and intended purpose, and the Department accordingly believes that length of pull can appropriately be measured for such weapons. The mere fact that a manufacturer may call a device a "stabilizing brace" does not prevent measurement of a length of pull when the device is, in reality, similar to a shoulder stock.

The Department acknowledges the suggestion of one commenter that Worksheet 4999 should have used a two-tiered approach that combines the length of pull and rear surface area, and, if this combination indicates the firearm is suitable to be fired from the shoulder, then to proceed to other characteristics. While the Department does not adopt the commenter's exact suggestion, the Department has determined that a two-tiered approach is a reasonable and clear method to evaluate whether the overall configuration of a firearm equipped with a "stabilizing brace" is

designed, made, and intended to be fired from the shoulder. After consideration of the comments, the rule states that the term "designed or redesigned, made or remade, and intended to be fired from the shoulder" includes a weapon that is equipped with an accessory, component, or other rearward attachment (e.g., a "stabilizing brace") that provides surface area that allows the weapon to be fired from the shoulder, provided that other factors, such as length of pull, indicate that the firearm is designed, made, and intended to be fired from the shoulder.

#### x. Attachment Method Comments Received

One commenter questioned why ATF would assign any points to items such as KAK-style and rifle-style buffer tubes and PDW-type guide rails that ATF has previously "approved" for use on pistols. The commenter had the same questions with respect to folding adapters and how ATF determines what a "modified shoulder stock" is under the "Attachment Method" category in Section III. Another commenter noted that the use of "folding adapters" serve the same functional purpose for brace-equipped pistols as they do for folding rifle stocks, *i.e.*, the user can fire the pistol without the device extended by folding the stabilizing brace or stock out of the way. The commenter further stated that, "[j]ust as a rifle with its stock folded does not suddenly become a non-rifle, a pistol with its brace folded does not suddenly become a non-pistol." Similarly, commenters disagreed with ATF's assignment of various "attachment methods," *i.e.*, "extended" tubes, "folding adapter[s]," and "spacers," that were each assessed two points, on the theory that each "increases the 'length of pull.'" Commenters believed that the factors under "Attachment Method" would create a double penalty for: (1) the attachment method that increases the length of pull and (2) the resulting longer length of pull itself, which would already be accounted for under "Length of Pull."

One commenter argued that the factor examining "aim-point" not only is vague and has nothing to do with shouldering but is also duplicative of the analysis conducted under the "Peripheral Accessories" section. Another commenter asked for

clarification on the factor "Attachment method creates an unusable aim-point (slant)" under the "Attachment Method" category. The commenter stated that the Department would need to evaluate a number of shooting positions to determine whether the aim-point is unusable without firing from the shoulder. For example, the commenter stated that when a firearm is fired from either a bench rest or the prone position, the firearm is not fired from the shoulder, yet the elevation of the firearm in relation to the user's body may be quite similar to a shoulder-mounted firearm. This, according to the commenter, would make aim-point unusable for freehand shooting from a standing position, but very usable from a bench rest or from the prone position." Another commenter criticized the lack of explanation for how certain methods of attachment would affect other criteria that ATF already identified as indicative of an intent to fire a weapon from the shoulder. The commenter asserted that attachment method has nothing to do with a device's ability to be fired from the shoulder and that a final rule should not consider attachment method.

#### Department Response

The Department agrees with commenters' concerns regarding the assessment of duplicate points for "attachment method" and "length of pull." The Department does not adopt the point system from Worksheet 4999. Rather, under this final rule, if a weapon equipped with an accessory, component, or other rearward attachment (e.g., a "stabilizing brace") has surface area that allows it to be fired from the shoulder, then the other objective design features and other factors listed in this rule are to be considered in determining whether the firearm is designed, made, and intended to be fired from the shoulder.

One objective design feature ATF may consider is whether the attachment is required for the cycle of operations of the weapon, which could indicate the firearm is not designed and intended to be fired from the shoulder. For example, an AR-type pistol with a standard 6- to 6½-inch buffer tube may not be designed, made, and intended to be fired from the shoulder even if the buffer tube provides surface area that allows the firearm to be shoulder fired.

On an AR-type pistol, the buffer tube encases a spring that drives the bolt forward when the bolt is driven into the buffer tube by the gas from the initial

shot. The picture below displays the internal function of an AR-15 type rifle. The AR-type pistol is a variant of the rifle with the stock removed and has the

same receiver and buffer tube function of the rifle version.

BILLING CODE 4410-FY-P



**Internal function of an AR-type rifle**

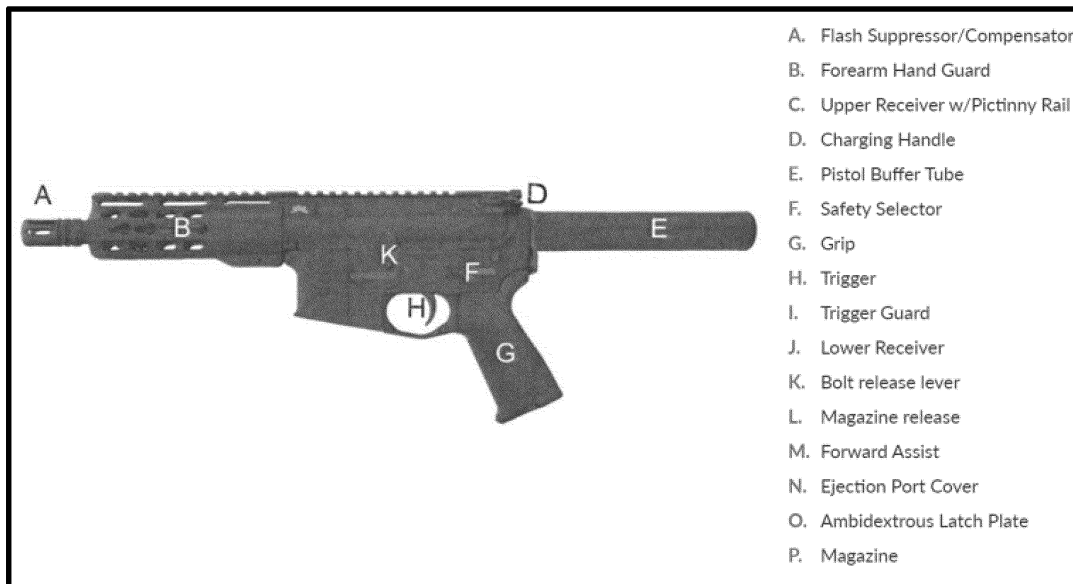

**“PA-15 Pistol” in Palmetto State Armory product manual<sup>130</sup>**

In contrast, if the buffer tube, receiver extension, or other component is not required for the cycle of operations of the weapon, ATF may conclude it serves no purpose but to extend the rear surface area of the weapon toward the shooter to provide surface area for shouldering and to increase the overall

length of pull, which in turn provides a shooter a better aim-point on the firearm and horizontal stabilization to shoulder-fire the firearm. For example, a “brace” device or other rearward attachment on AK-type pistol serves only to extend the surface of the firearm rearward. Similarly, the CZ Scorpion

EVO3 S1 (pictured below) does not incorporate a buffer tube or material beyond the bottom of the pistol grip, unlike the AR-type rifle. Instead, a folding “brace” is added to the firearm in addition to the material required for the operation of the firearm.

<sup>130</sup> Palmetto State Armory, *Product Manuals-PA-15 Pistol*, [https://palmettostatearmory.com/help-](https://palmettostatearmory.com/help-center/product-manuals/pa15-pistol.html#safety)

[center/product-manuals/pa15-pistol.html#safety](https://palmettostatearmory.com/help-center/product-manuals/pa15-pistol.html#safety) (last visited Dec. 12, 2022).



**CZ Scorpion EVO3 S1 (AK style variant) without an extension<sup>131</sup>**



**CZ Scorpion EVO 3 S1 w/ Flash Can and Folding Arm Brace (Discontinued)<sup>132</sup>**

Another example is the HK SP5 firearm, which functions with no material beyond the pistol grip of the firearm. But a “stabilizing brace” can be attached to additional material such as PDW-type guard rails, as demonstrated

below. This attachment extends the rear surface of the firearm, and the PDW-type guard is additional material that also has no purpose in the cycle of operations on a HK SP5 firearm. The fact that this excess material is not

necessary to the cycle of operations would be an objective design feature suggesting that the firearm with the “stabilizing brace” is designed, made, and intended to be fired from the shoulder.

<sup>131</sup> CZ USA, *CZ Scorpion Evo 3 S1 Pistol*, <https://cz-usa.com/product/cz-scorpion-evo-3-s1-pistol-2/> (last visited Dec. 12, 2022).

<sup>132</sup> CZ USA, *CZ Scorpion EVO 3 S1 Pistol w/Flash Can and Folding Brace-Discontinued*, <https://cz-usa.com/product/cz-scorpion-evo-3-s1-pistol-w->

[flash-can-and-folding-brace/](https://cz-usa.com/product/cz-scorpion-evo-3-s1-pistol-w-flash-can-and-folding-brace/) (last visited Dec. 12, 2022)



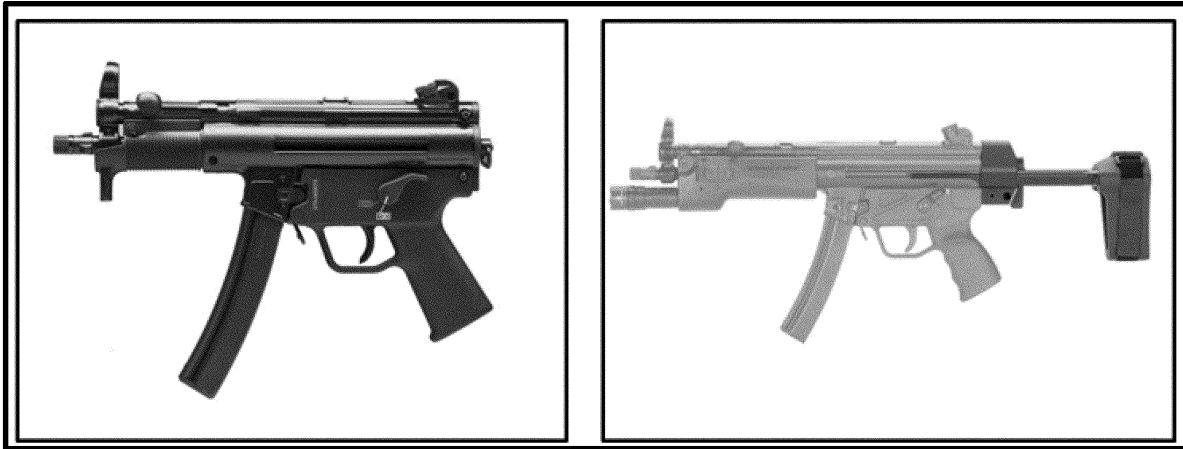

**Heckler & Koch (H&K) SP5 pistol (left) and Adjustable PDW type guard rail with a “stabilizing brace” device on HK SP5 (right)<sup>133</sup>**

The Department acknowledges that ATF previously “approved” KAK-style and rifle-style buffer tubes and PDW-type guide rails for use on pistols and that ATF specifically permitted these types of extensions to attach a “stabilizing brace” device onto the rear of a weapon.<sup>134</sup> The Department also acknowledges but disagrees with commenters that did not believe folding

adapters should be considered because the purpose of a folding adapter is to fold out of the way the “brace” or shoulder stock on a firearm. As discussed, the addition of an accessory to the rear of the firearm can also add material that provides surface area for shouldering and can extend the length of pull to effectuate shoulder fire. For these reasons, the Department disagrees

with these commenters and maintains that these types of rearward attachments, like the folding adapter pictured below, are additional material that, when added to the end of a firearm, may indicate that the firearm is designed, made, and intended to be fired from the shoulder.

<sup>133</sup> Heckler & Koch USA, *SP5K-PDW-Heckler & Koch*, <https://hk-usa.com/product/pistols/> (last visited Dec. 12, 2022); SB Tactical, *HKPDW*,<sup>TM</sup>

<https://www.sb-tactical.com/product/hkpdw/> (last visited Dec. 12, 2022).

<sup>134</sup> Letter from ATF #304296 (Dec. 22, 2015) (PDW rails); Letter from ATF #306285 (Oct 31, 2017) (KAK tube).

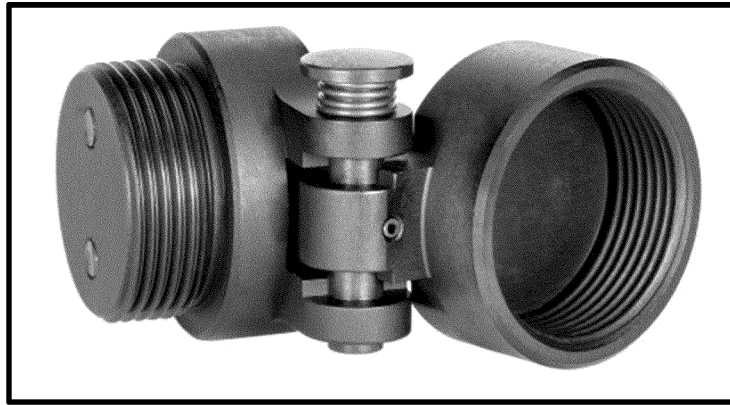

Folding adapter



Folding adapter attached to a pistol with a purported “stabilizing brace”

**BILLING CODE 4410-FY-C**

Likewise, an extended AR-type pistol buffer tube, which is a longer buffer tube than the standard buffer tubes required for the operation of the firearm, or the inclusion of spacers that extend the length of pull, are also examples of the addition of material to the rear of a firearm that provides surface area for shouldering and extends the length of pull to effectuate shoulder fire.

xi. Peripheral Accessories and “Stabilizing Brace” Modifications/ Configurations

Comments Received

Some commenters were troubled with the inclusion of “accessories” in the evaluation process because, in their opinion, ATF only has the authority “to regulate firearms and ammunition in interstate commerce.” Commenters stated that ATF appeared not to be concerned about the impact the worksheet would have on AR-15 enthusiasts who enjoy trying new or different components, *i.e.*, sights, optics, or telescoping arms to ensure the best fit. Specifically, commenters stated that, because of such changes, “their ‘score’

on” Worksheet 4999 would change with each new combination, thereby likely resulting in a new register or destroy decision tree.”

The congressional Second Amendment Caucus disagreed with ATF’s statements from the NPRM. The commenter read the NPRM as indicating that, simply by adding peripheral accessories such as a hand stop or sights, a person may inadvertently “void” ATF’s prior classification of a weapon with an attached “stabilizing brace” as not being a “rifle” under the NFA. That person would then be in possession of an unregistered short-barreled rifle. The commenter stated that it would be “unjustifiable” for a firearm’s classification to change “simply because a person has customized it with individualized accessories.” (Emphasis omitted.)

Another commenter suggested that the worksheet should be revised to say that no points would be awarded for a hand stop unless the length of pull and rear surface area of the stabilizing brace are suitable for firing from the shoulder, and, if so, then two points would be awarded for the secondary grip, and, if

not, the worksheet does not apply to the secondary grip, but the firearm may be classified as an NFA “any other weapon.” Under this proposal, no points should be assigned for the “no sights” feature. The same commenter also stated that, if the physical size and configuration of a stabilizing brace do not allow for shouldering at all, then the presence of a hand stop is irrelevant and does not indicate that the gun will be fired from the shoulder.

Another commenter wanted additional information on Worksheet 4999 because it was unclear if the only “accessory” that had to be removed to make the initial determination regarding weight and length prerequisites is an attached stabilizing brace or whether other accessories (*e.g.*, sights, fore-end, pistol grip, bipod, etc.) would have to be removed as well.

Commenters did not understand how a “sighting” accessory could transform a pistol with a “brace” into an NFA weapon and disagreed with Worksheet 4999 for including a “sighting” factor. Many commenters disagreed with the notion that any form of sight or even the absence of sights might make a pistol a

rifle or that pistols with certain sights or other accessories could become short-barreled rifles. Many commenters said optics do not change the function of a brace and should not be considered in the evaluation of a pistol or rifle. Commenters stated that sights can be seen very easily when firing with one hand and that their use should be assigned zero points.

Another commenter put it a slightly different way. The commenter found it “unclear how the presence or absence of sights would be determinate of whether the firearm is a pistol or short-barreled rifle,” and the commenter asserted that “attributing the same points to a firearm equipped with a set of rifle-type sights as the same firearm with no sight installed makes little sense.” The commenter continued, stating it is “nonsensical that lacking sights could make a firearm a short-barreled rifle under the Rule.” “End users are free to choose what optics or sights to put on their firearm if none are included from the factory, and many of those optic and sight choices would result in accrual of zero points.” One commenter questioned why the presence of no sights (which would have accrued one point on the worksheet) would indicate a firearm was made to be shouldered.

Another commenter stated any person can shoot a firearm one handed with a sight or scope, so this factor, according to the commenter, would have automatically given every firearm with a sight or scope 4 points, thereby making every firearm a short-barreled rifle by ATF’s proposed factoring criteria. One organization raised a question about ATF’s purported prohibition of various types of sights, which, the commenter claimed, ATF erroneously asserted “must be fired from the shoulder in order to use the sight.”

Another commenter, who identified as a National Guard Instructor, suggested that ATF include a list of acceptable style of optics for the factor “Presence of a Sight/Scope with Eye Relief Incompatible with one-handed fire,” as listed on Worksheet 4999. Doing so, according to the commenter, would help people know what standards ATF proposed to use when using the worksheet to determine if a firearm is classified as a rifle or short-barreled rifle subject to the NFA.

A few commenters wrote about the “bipod” factor on the proposed Worksheet. One commenter argued that it was nonsensical to accrue points for presence of a bipod because alternate shooting positions should be encouraged for safety purposes. The commenter stated that attachment of a

bipod allows the shooter to choose to rest the forward portion of the firearm on a solid surface for stability. If a suitable solid surface is not available, the user should have the ability to use an equipped stabilizing brace for stability. Another commenter argued that the “[w]orksheet should not award points for the presence of a bipod or monopod unless length of pull and rear surface area are both suitable for firing from the shoulder. And then, only one point should be assigned.” (Emphasis omitted.)

Finally, at least one commenter argued that the factors under the section of the worksheet titled “Stabilizing Brace” Modifications/Configurations were arbitrary. For example, the commenter stated that ATF did not define when a strap is “too short” to function for the “cuff-type” or “fin-type” design and that this feature was duplicative of the “stabilizing support factor” in Section II of the proposed worksheet. The commenter argued generally that other factors in this part conferred too much discretion on ATF and that the factors were arbitrary and therefore the entire part examining “Stabilizing Brace” Modifications/Configurations should be removed.

#### Department Response

The Department agrees that ATF’s authority under the GCA and NFA is to regulate firearms and ammunition; however, the Department disagrees that ATF is prohibited from considering components or peripheral accessories attached to a firearm in the evaluation process of a firearm. ATF’s FATD considers the configuration of the firearm, which includes whether certain accessories added by either the manufacturer or the individual affect the classification of a firearm. In the NPRM, the Department included on the Worksheet 4999 accessories that may impact whether a firearm is designed, made, and intended to be fired from the shoulder. After considering the comments, the Department has determined that the presence of sights or scopes with eye relief that require shouldering of the firearm to be used is an objective design feature indicating a firearm is designed, made, and intended to be fired from the shoulder. As explained below, the Department agrees with commenters and does not consider hand stops, secondary grips, or bipod or monopods to be objective design features indicating that a firearm is designed and intended to be fired from the shoulder.

The Department disagrees that it has not considered the interests of AR–15 enthusiasts by including accessories in

the analysis of whether a firearm is designed, made, and intended to be fired from the shoulder. The NPRM and proposed Worksheet 4999 would not have prevented AR–15 enthusiasts from altering their firearms, and individuals may continue to install accessories on a firearm under this final rule. However, if the firearm falls within the purview of the NFA (*i.e.*, designed, made, and intended to be fired from the shoulder with a barrel less than 16 inches) then the firearm must be registered in the NFRTR. The Department agrees that an unintended consequence of the proposed worksheet and the point system was that the addition or removal of a single peripheral accessory could redesign the firearm to be fired from the shoulder or remove the firearm from the purview of the NFA. Therefore, the Department does not adopt the proposed Worksheet 4999 and, as discussed, several of the peripheral accessories listed in the worksheet are not considered objective design features in the final rule.

The Department agrees that two factors—the presence of a hand stop and secondary grip—are not relevant objective design features because they only are relevant if firearm has a length of pull consistent with rifles and rear surface area indicating the firearm is suitable to be fired from the shoulder. In other words, the objective design features of length of pull and rear surface area already take into account these types of peripheral accessories, including secondary grips. Additionally, the secondary grip may be a factor indicating that a firearm is not a pistol (*i.e.*, a firearm designed, made, and intended to be fired with one hand), but it is not a factor indicating that the firearm is designed, made, and intended to be fired from the shoulder.

For the same reasons that secondary grip and hand stop are not included, the Department also agrees that the presence of a bipod or monopod is not an objective design feature of a firearm designed and intended to be fired from the shoulder; this feature can be a characteristic of both a rifle and a pistol and itself is not an objective design feature of a rifle. Therefore, a bipod or monopod is not included as an objective design feature in the rule.

Similarly, the Department agrees that optics on a firearm should not transform a firearm into a rifle by themselves, and the Worksheet 4999 was not intended to make optics a transformative characteristic. However, the Department disagrees with any notion that the optics on a firearm are irrelevant to the question of whether a firearm is a rifle within the meaning of the relevant



statutes. The presence of sights or a scope on a firearm that requires the firearm to be shouldered in order for the sights or scope to be used as designed indicates that the firearm is designed, made, and intended to be fired from the shoulder. In applying the statutory definition, ATF intends to examine the sights or scope on a submitted firearm sample as compared to those sights or scopes featured on a rifle to determine whether the sights or scope on the firearm being evaluated must be shouldered to use the sights or scope as designed.

The alignment of sights and optics is an important feature of a weapon designed, made, and intended to be fired from the shoulder. The industry recognizes the importance of the sights or aiming device in shouldering a

firearm. SAAMI defines “shoulder” as, in relevant part, the “[a]ct of placing a shotgun or rifle to a shooter’s shoulder, in order to properly align the sights and fire at a target.”<sup>135</sup> The American Rifleman states that “[a] rifle stock is a device that provides an interface between the shooter and the rifle. Its foremost purpose is to allow the shooter a repeatable point of contact in relation to the rifle’s aiming device.”<sup>136</sup> The final rule also refers to the “eye relief” of any attached sights or scopes. “Eye relief” is the distance between the eye and the scope or sight that is required to provide the best image of the object being targeted.<sup>137</sup> If sights or a scope requires the firearm to be shouldered in order for the shooter to use the sights or scope to view the target, then the firearm is more likely to be designed,

made, and intended to be fired from the shoulder because firing from other positions would impair the use of the sight or scope.

Therefore, some of the sights listed on Worksheet 4999 are relevant to the question of whether a particular configuration is a rifle within the meaning of the relevant statutes. For instance, back-up or flip-up sights that can only be effectively used when the firearm is shouldered are an indicator that a firearm is designed, made, and intended to be fired from the shoulder. Similarly, the presence of a reflex sight with flip-to the side magnifier that has limited eye relief (*i.e.*, the sight is unusable unless aimed and fired from the shoulder) is a design incorporated on firearms designed, made, and intended to be fired from the shoulder.



**Example of firearm with thermal scope with eye relief that requires shouldering of the firearm in order to be used as designed.**

The Department acknowledges that Worksheet 4999 incorrectly considered and assigned points for the lack of sights to determine if a firearm is a rifle designed, made, and intended to be fired from the shoulder. As discussed, the Department notes that the correct inquiry for purposes of determining whether a firearm equipped with a “brace” is designed, made, and intended to be fired from the shoulder is to consider whether the sight or scope has an eye relief that requires shouldering in order to be used as designed. Therefore, the Department

believes it is not necessary to provide a list of acceptable style optics that are compatible with one-handed fire, as requested in the comments.

Lastly, the Department agrees with the commenter that it should not examine “stabilizing brace” modifications or configurations, and this characteristic should not be considered in the final rule. As discussed above, ATF evaluates and classifies firearms based upon the firearm’s objective design features and other factors in light of the statutory and regulatory definitions. This rule clarifies the term “designed or redesigned, made

or remade, and intended to be fired from the shoulder” includes a weapon that is equipped with an accessory, component, or other rearward attachment (*e.g.*, a “stabilizing brace”) that provides surface area that allows the weapon to be fired from the shoulder, provided that other factors—such as the presence of sights or a scope with eye relief that require the weapon to be fired from the shoulder in order to be used as designed—also indicate the weapon is designed, made, and intended to be fired from the shoulder

<sup>135</sup> SAAMI, *Glossary*, Sporting Arms and Ammunition Manufacturers’ Institute, Inc., <https://saami.org/glossary/shoulder/> (last visited Dec. 13, 2022).

<sup>136</sup> Dave Campbell, *Back to the Basics: Rifle Stock Components & Designs*, *The American Rifleman* (Feb. 15, 2017), <https://www.americanrifleman.org/content/back-to-basics-rifle-stock-components-designs/>.

<sup>137</sup> R.A. Steindler, *New Firearms Dictionary* 112 (1985) (defining “eye relief” as the “distance required between the eye and ocular lens of a telescopic sight that gives the user the best image of the object viewed”).

## c. Regulating Intent

## Comments Received

Commenters were concerned that ATF was presuming the intentions of both users and manufacturers of “stabilizing braces.” One commenter said the proposed definition would define the intent of the manufacturer or designer of the firearm based solely upon objective features. The commenter further elaborated, stating, ATF contends that the intent of manufacturers or makers may not be as stated, but “[c]onversely, a manufacturer or designer may have all genuine intents and purposes of having a firearm not be shot from the shoulder, but have their firearm classified as a ‘rifle’ on the basis that it met the point requisite! Both of these results ignore the Congressional intent of the meaning of the term ‘rifle.’” Other commenters said it was unclear what additional evidence ATF would consider in determining if a manufacturer “expressly intended to design the weapon to be fired from the shoulder.” Finally, other commenters contended that, although ATF said that the manufacturer’s stated intent should play a role, the worksheet did not take such intent into account because it focused only on design features.

## Department Response

The Department disagrees that the definition, as proposed and finalized, defines the intent of a manufacturer or designer based solely upon objective features. As stated, ATF considers the manufacturer’s or designer’s stated intent, but the Department has determined that the relevant statutes would not be properly implemented by simply assuming that the firearm should be classified entirely in accordance with that stated intent; doing so would permit circumvention of the NFA solely based on the manufacturer’s or maker’s words. Such an absurd result would be inconsistent with the best understanding of the relevant statutory definitions, which encompass weapons designed, made, and intended to be fired from the shoulder—not merely weapons that the manufacturer expressly states are to be fired from the shoulder. Put another way, Federal regulation of only those “rifles” the manufacturer wanted to market as such would leave other items completely unregulated regardless of their objective design features, and regardless of whether those other items pose the exact same dangers as the weapons marketed as “rifles.” Hence, to properly apply the relevant statutory definition, the Department has determined that the

classification of a firearm should include an evaluation of whether its objective design features indicate it is designed, made, and intended to be fired from the shoulder. ATF, as stated in this rule, may consider a manufacturer’s stated intent or marketing materials, as well as evidence of likely use in the general community, but ATF would take these considerations into account in conjunction with the objective design features of the weapon.

To assess the manufacturer’s or maker’s intent when following the process described in this final rule, ATF’s FATD considers both: (1) the marketing of the attachment (*e.g.*, indirect marketing through persons that manufacture or sell “stabilizing braces” but not firearms) and the direct marketing from the firearm manufacturer regarding the firearm to which the attachment or “brace” is assembled, and (2) information demonstrating the likely use of the weapon by the general community, including both the manufacturer’s stated intent when submitting its item for classification and use by members of the firearms industry, firearms writers, and in the general community. *Cf. Posters ‘N’ Things v. United States*, 511 U.S. 513, 521–22 (1994) (explaining that whether an item is “primarily intended” for a specified use is an objective analysis that must focus on the “likely use” of that item in the general community, rather than the subjective intent of a particular person).

FATD in the past has found that manufacturers or makers often assert that a device is a “stabilizing brace” or that a firearm is a “pistol” when submitting a firearm for classification, but then advertise these products later as devices that permit customers to fire their “pistols” from the shoulder, *e.g.*, to make a short-barreled rifle without complying with the requirements of the NFA (examples provided below). Such production and advertising are far from, and not consistent with, the incidental use of a “brace” as a shouldering device. Instead, the manufacturer’s own marketing materials directly contradicted the purpose they stated to ATF when submitting the firearm and indicated that the firearm, in reality, is intended to be fired from the shoulder. Thus, in considering intent under this final rule, ATF will consider both the stated intent upon submission to ATF and the marketing materials associated with the “stabilizing brace.” Additionally, FATD under the final rule may also examine information demonstrating the likely use of the weapon in the general community, such

as the proposed use by the manufacturer or use by members of the firearms industry, firearms writers, and in the general community. These sources provide insight into the ways that manufacturers market their products and whether the firearm equipped with a “stabilizing brace” as configured is designed, made, and intended to be shouldered fired.

By considering direct or indirect marketing or promotional materials available through videos, advertisements, or other sources, ATF can verify the manufacturer’s purported intent regarding the use the weapon. Indirect marketing materials can include statements from accessories manufacturers for the accessories that a firearms manufacturer attaches or incorporates into its firearm, such as a “brace” manufacturer that advertises that a “stabilizing brace” is a method to circumvent the NFA. Such an advertisement would not be published by the firearms manufacturer itself but might still be referenced by the manufacturer of the “stabilizing brace,” and it would still be considered relevant in the assessment of whether a weapon is a rifle. Additionally, ATF can look to other available information, including the manufacturer’s own statements, to assess the general community’s likely use of the weapon to resolve the intended use of the device.

Below is an example of how ATF would consider these materials and information for an AR-type firearm with an SBA3 “stabilizing brace” device. In evaluating a firearm equipped with an SBA3 “brace” device, FATD will consider the firearm manufacturer’s or maker’s direct and indirect marketing and promotional materials, which may include the direct or indirect materials of the accessory (or “brace”) maker whose product is used by the manufacturer or maker of the firearm. Even though, as earlier discussed, the maker of the SBA3 stated to ATF that an SBA3 “stabilizing brace” was “intended to assist those with limited strength or mobility while shooting from the one-handed pistol precision stance or one-handed supported stance,”<sup>138</sup> the maker of the SBA3 also included material on its website that stated “stabilizing braces” are a way to avoid NFA controls and to “Stiff Arm the Establishment.”<sup>139</sup> The Department

<sup>138</sup> Letter for John Spencer, Chief, Firearms Technology Branch, ATF, from Alex Bosco, NST Global (Nov. 8, 2012).

<sup>139</sup> See, *e.g.*, SB Tactical (June 3, 2017), <https://www.archive.org/web/20170603230920/https://www.sb-tactical.com/>; SB Tactical (May 2, 2019), <https://www.archive.org/web/20190502221627/https://www.sb-tactical.com/>.



believes it would be appropriate for ATF to consider this indirect marketing material from the brace manufacturer,

along with the weapon's objective

design features, when making a classification.

BILLING CODE 4410-FY-P

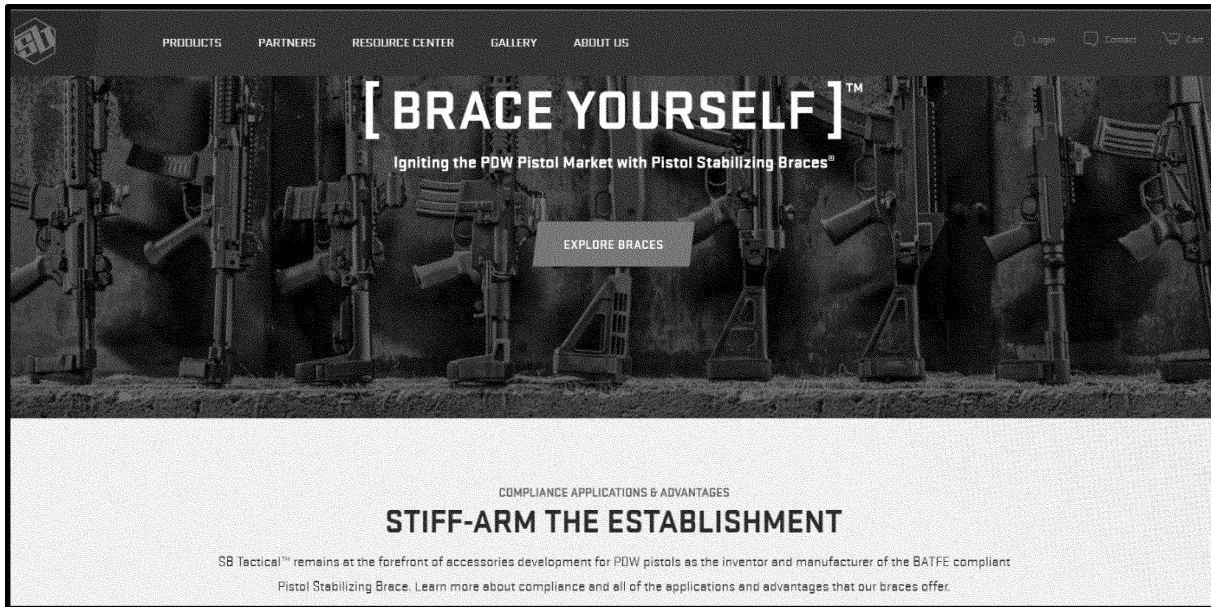

**SB Tactical's Homepage from June 2017 to May 2019 (background picture since changed but the phrase "*Stiff-Arm the Establishment*" was visible during that entire timeframe)**

In considering information demonstrating the likely use of the firearm equipped with an SBA3 "stabilizing brace" in the general community, ATF would also consider information such as the firearms

magazines that similarly exhibited the use of this "stabilizing brace" as a shoulder stock.<sup>140</sup>

<sup>140</sup>James Tarr, *POF Revolution Pistol Review*, *Guns and Ammo* (Apr. 1, 2019), <https://>

[www.gunsandammo.com/editorial/pof-revolution-pistol-review/359137](https://www.gunsandammo.com/editorial/pof-revolution-pistol-review/359137); Tom Beckstrand, *BCM Recce-11 MCMR Pistol Review*, *Guns and Ammo* (Oct. 28, 2019), <https://www.gunsandammo.com/editorial/bcm-recce-11-mcmr-pistol-review/369026>.



In the following examples, with images, the firearms were being sold as pistols while it was evident that they were designed, made, and intended to be rifles.



**Firearms writer utilizing the SBA3 accessory as a shoulder stock (Firearms News, September 2018, Issue 18) to fire a Patriot Ordnance Factory (POF) “Revolution,” 7.62 NATO caliber firearm with long-distance scope—Note this firearm is being sold as a “pistol” while clearly designed, made, and intended to be a “rifle”**



**Guns & Ammo (September 2019, page 36) covering the Bravo Company Manufacturing (BCM) Recce-11 MCMR 5.56 NATO caliber firearm with long-distance scope and SBA3 “stabilizing brace”—Note this firearm is being sold as a “pistol” while clearly designed, made, and intended to be a “rifle”**

Additionally, ATF would review other advertisements displaying the

SBA3 accessory as a shoulder stock. These include:

<sup>141</sup> King of Compact Hammers, Guns and Ammo (June 2019).

<sup>142</sup> Ballistic Staff, RipBrace: CMMG Teams with SB Tactical for Retractable AR Pistol Brace, Ballistic Magazine (Nov. 8, 2018), <https://>

[www.ballisticmag.com/cmmg-ripbrace-retractable-brace/](https://www.ballisticmag.com/cmmg-ripbrace-retractable-brace/).

**KING OF THE COMPACT HAMMERS**

**INTRODUCING THE HIGHLANDER 6.5 Grendel Pistol**

Factory 123 gr ammunition exits the 11 inch barrel at 2,300 fps. With a 2.5 inch sight height and a 200 yd zero, the trajectory is very flat out to 300 yds. The shooting window is less than 12 inches out to 300 yds. That's amazing!

0 Yards	-2.50 inches	Now, with 5/8 X 24 TPI at the muzzle to facilitate use with a .308 Silencer/Suppressor.
100 Yards	+2.55 inches	
200 Yards	0.00	
300 Yards	-11.42 inches	

The compact Highlander can easily be stored in your truck, car, boat, or home. Extend the stock and successfully engage targets out to 300 yards. If you want a compact hammer to defend your family or harvest game, then this is the firearm for you.

**HIGHLANDER**

Alexander Arms

Highlander also available in 17 PAK, 50 Round, and 300 Blk. Call (540) 639-8356 or visit [www.AlexanderArms.com](http://www.AlexanderArms.com)

Advertisement for Highlander “Pistol” with attached SBA3 “stock” (advertisement ran in Guns & Ammo June/July 2019)<sup>141</sup>

**STOCKS**

Webpage advertising the SBA3 accessory as a “stock”

**CMMG**

**RipBrace**

The RipBrace features CMMG's FASTBACK Technology that allows users to simply pull straight back to extend the brace without pressing a release lever or button like most adjustable AR arm braces employ. This instant deployment is a one-of-a-kind feature that makes the RipBrace an optimal choice for any AR pistol designated for personal defense.

This revolutionary brace also has personal position presets (P3 Technology) that allow users to adjust a screw into different adjustment holes to ensure the stock extends to the same preferred position each time. This revolutionary brace is exceptionally lightweight, has ambidextrous functionality and is ATF Compliant.

[cmmginc.com](http://cmmginc.com)

Ballistic magazine of the “RipBrace” version of the SBA3 accessory, advertising the ability to quickly extend the “stock”<sup>142</sup>



and intended to be fired from the shoulder demonstrate the actual intended use of the item. Thus, in considering a manufacturer's assertion to ATF that the firearm is designed and intended to be fired with one hand with the assistance of a "stabilizing brace," FATD would be able to look to the manufacturer's direct and indirect materials, as well as information demonstrating likely use in the general community, to assist in determining whether the firearm is or is not configured to be fired from the shoulder. As evidenced by online videos,<sup>143</sup> marketing materials from manufacturers of various models of "stabilizing braces,"<sup>144</sup> and even comments on the NPRM, firearms with attached "stabilizing braces" are being used to evade regulation under the NFA. Thus, the final rule adopts the best interpretation of the relevant statutes by examining a firearm's objective design features, along with direct and indirect marketing materials and other information to determine whether a firearm is designed, made, and intended to be fired from the shoulder.

#### 4. Constitutional Concerns

##### a. Violates the Second Amendment

###### Comments Received

Commenters opposed to the NPRM broadly opined that ATF should not be allowed to violate their Second Amendment rights and that this rule is a "slap in the face" to millions of Americans who own and use pistol braces. Other commenters argued the rule would ban pistols that are protected by the Second Amendment. Commenters argued that the rule "attacks" the Second Amendment. Thousands of commenters cited *District of Columbia v. Heller*, 554 U.S. 570 (2008), and argued that the rule unlawfully infringes on the Second Amendment rights of millions of citizens to keep and bear arms in common use. Other commenters stated the term "infringed" in the Second Amendment means "to limit or undermine" and "actively break the terms of a law or agreement," and that in return for the colonies giving power to the creation of a Federal government, the government agreed not to infringe on the rights of people to keep and bear arms. Commenters argued that with this rule, ATF is infringing on the rights of people to keep and bear arms under the Second Amendment. Another commenter stated that the right to install a stabilizing brace to assure safe

and accurate use and operation of a weapon, particularly for defense of self and property, is a "core value" protected by the Second Amendment.

###### Department Response

The Department disagrees with commenters that this regulation violates the Second Amendment. *Heller* and subsequent judicial decisions support the Department's view that weapons regulated by the NFA, such as short-barreled rifles, fall outside the scope of the Second Amendment. The Supreme Court in *Heller*, 554 U.S. at 570, held the Second Amendment protects an individual right to bear arms for traditional, lawful purposes such as self-defense. At the same time, the Court recognized that the rights established under the Second Amendment are not absolute or unlimited. *Id.* at 595. *Heller* specifically recognized an "important limitation on the right to keep and carry arms," *i.e.*, that the right is limited to "the sorts of weapons . . . in common use at the time." *Id.* at 627. The Court stated that this limitation is supported by "the historical tradition of prohibiting the carrying of 'dangerous and unusual weapons.'" *Id.* The Court rejected the "startling" position that "the National Firearms Act's restrictions on machineguns . . . might be unconstitutional, machineguns being useful in warfare in 1939." *Id.* at 624. *Heller* thus made clear that machineguns and short-barreled shotguns are "weapons not typically possessed by law-abiding citizens for lawful purposes," and thus fall outside the scope of the Second Amendment as historically understood. *Id.* at 625; *see also id.* at 627 (accepting that M-16 rifles are dangerous and unusual weapons that may be banned).

Indeed, after *Heller*, lower courts similarly held that short-barreled shotguns and short-barreled rifles are dangerous and unusual weapons that fall outside the scope of the Second Amendment because of the danger presented. *United States v. Cox*, 906 F.3d 1170, 1186 (10th Cir. 2018) ("we take our cue from *Heller* and conclude that the possession of short-barreled rifles falls outside the Second Amendment's guarantee"); *United States v. Gilbert*, 286 Fed. App'x 383, 386 (9th Cir. 2008) (approving jury instructions that an individual does not have a Second Amendment right to possess a short-barreled rifle, and observing that, "[u]nder *Heller*, individuals still do not have the right to possess machineguns or short-barreled rifles"); *Marzzarella*, 614 F.3d at 90-95 (explaining that a long gun with a shortened barrel is both dangerous and

unusual, because "its concealability fosters its use in illicit activity," and "because of its heightened capability to cause damage" and that the Second Amendment does not provide protection for all types of weapons); *Gonzalez*, 2011 WL 5288727, at \*5 ("Congress specifically found that 'short-barreled rifles are primarily weapons of war and have no appropriate sporting use or use for personal protection.'" (quoting S. Rep. No. 90-1501, at 28)). Thus, *Heller* and subsequent judicial decisions support the Department's view that the weapons regulated by the NFA, such as short-barreled rifles, were not historically protected by the Second Amendment and thus fall outside the scope of the Second Amendment. Nothing in the Supreme Court's recent decision in *New York State Rifle & Pistol Ass'n v. Bruen*, 142 S. Ct. 2111 (2022), changes this analysis.<sup>145</sup> *See id.* at 2162 (Kavanaugh, J. concurring) (reiterating *Heller's* finding that "dangerous and unusual weapons" are outside of the Second Amendment's protections).

Further, the Department also notes that neither the rule nor the NFA bans the possession of the relevant firearms. In regulating short-barreled rifles, Congress only requires the registration of the firearms in the NFRTR and the payment of a making or transfer tax, neither of which prohibits a person's ability to possess these weapons. This rule does no more than clarify the Department's understanding of the best meaning of the relevant statutory provisions.

<sup>145</sup> The Supreme Court's decision in *Bruen* abrogated several circuit court decisions applying a "two-step" framework for analyzing Second Amendment challenges." *Id.* at 2125. At the first step, courts asked whether the "challenged law regulates activity falling outside the scope of the [Second Amendment] right as originally understood." *Id.* at 2126 (quotation marks omitted). If so, then the law did not violate the Second Amendment. But if the law did regulate activity within the amendment's scope, then courts applied a means-end test similar to the strict or intermediate scrutiny used to evaluate laws burdening First Amendment rights. *Id.* at 2126-27. The Court in *Bruen* largely approved of the first step, which "is broadly consistent with *Heller*," *id.* at 2127, but specifically disapproved of the second step, *see id.* Thus, although *Bruen* abrogates previous decisions applying the means-end test, the Department does not believe the case casts doubt on courts' prior conclusions that, based on historical tradition, the Second Amendment does not extend to dangerous and unusual weapons. *See, e.g., Marzzarella*, 614 F.3d at 94 ("the Supreme Court has made clear the Second Amendment does not protect . . . types of weapons" such as "machine guns or short-barreled shotguns—or any other dangerous and unusual weapon").

<sup>143</sup> *See supra* notes 96-98.

<sup>144</sup> *See supra* notes 90-94.



## b. Violates the Fourth Amendment

## Comments Received

Numerous commenters stated that gun-owning Americans will see this rule as a step towards gun confiscation. One commenter stated that ATF has allowed the legal production and sale of these pistols with “stabilizing braces” for years and, as such, their abrupt removal from the legal use violates the Fourth Amendment.

## Department Response

The Department disagrees that this rule violates the Fourth Amendment. The commenters appear to misunderstand the scope and intent of the rule and it is unclear how a “search” or “seizure” could result from this rule. The rule acknowledges that firearms with an attached “stabilizing brace” that meet the definition of “firearm” as defined under the NFA are subject to the registration, transfer, and taxes imposed by the NFA and to additional requirements under the GCA. The Department is not aware of any precedent supporting the view that determinations that certain weapons fall within the purview of the NFA violate the Fourth Amendment. A seizure in “[v]iolation of the Fourth Amendment requires an intentional acquisition of physical control.” *Brower v. County of Invo*, 489 U.S. 593, 596 (1989). This rule does not violate the Fourth Amendment, as it makes clear that it does not require the Government to seize or confiscate “stabilizing braces” or firearms with an installed “stabilizing brace.” First, the Department reiterates that firearms with an attached “stabilizing brace” that fall outside the purview of the NFA may continue to be possessed by individuals. Second, the public may continue to possess, transfer, or sell “stabilizing brace” devices. Lastly, if a firearm with an attached “stabilizing brace” is a short-barreled rifle under the NFA, an owner of any such firearm may comply with the options set forth in the rule to lawfully possess the firearm. See section V.B of this preamble.

## c. Unconstitutional Taking Under the Fifth Amendment

## Comments Received

Commenters believed that ATF should not take action against citizens who have already or in the future will purchase “stabilizing braces.” Several commenters stated that citizens have spent millions of dollars in taxes and converting firearms and will now be required to destroy or surrender their personal property without compensation. Commenter believed this rule will unjustly deprive owners of

their property without compensation, as they claimed they would be forced to dispose of the “brace”; they asked if ATF is planning to compensate individuals for every “stabilizing brace” that must be removed. Similarly, some commenters contended that the rule needs to be amended to reimburse owners for their purchases, as they were made in good faith.

Another commenter stated that the proposed rule would be like “forced labor, the taking of property without just compensation or due process, and a little extortion.” At least one commenter argued that each of ATF’s suggested remedies provided to avoid committing felonies by retaining previously authorized “brace” devices creates significant tension with the constitutional protections provided by the Due Process Clauses of the Fifth and Fourteenth Amendments, and that each of the alternatives the government provides “qualify as a Government taking under the [Fifth] Amendment.” In particular, the commenter said that “the Government commits a regulatory taking by taking uses of the property that once had greater utility.”

## Department Response

The Department disagrees that this rule constitutes a taking under the Fifth Amendment, which prohibits the Government from taking “private property . . . for public use, without just compensation.” U.S. Const. amend. V. As an initial matter, this rule itself cannot violate the Takings Clause because the owners of weapons affected by the rule do not have a protectable property interest in the unregulated possession of weapons covered by the NFA. “[T]o have a cause of action for a Fifth Amendment taking, the plaintiff must point to a protectable property interest that is asserted to be the subject of the taking.” *Palmyra Pacific Seafoods, LLC v. United States*, 561 F.3d 1361, 1364 (Fed. Cir. 2009). However, the “government does not take a property interest when it merely asserts a ‘pre-existing limitation upon the [property] owner’s title.’” *Cedar Point Nursery v. Hassid*, 141 S. Ct. 2063, 2079 (2021) (quoting *Lucas v. S.C. Coastal Council*, 505 U.S. 1003, 1028–29 (1992)). Or, as the Federal Circuit recently explained in a similar context, where there is a “preexisting federal statutory prohibition on possession or transfer of” an item, and where that prohibition is “subject to a valid implementation by the Attorney General,” individuals “lack[] a property right in what they allege was taken.” *McCutchen v. United States*, 14 F.4th 1355, 1365 (Fed. Cir. 2021).

Here, the NFA provides preexisting Federal statutory requirements regarding the transfer and making of certain kinds of rifles; and this final rule sets forth the Attorney General’s interpretation of those statutory requirements. The rule makes clear that weapons with an attached “stabilizing brace” that, based on their objective design features and other evidence, are designed, made, and intended to be fired from the shoulder and have a barrel of less than 16 inches or an overall length of less than 26 inches are short-barreled rifles under the NFA. Because the rule merely clarifies when a weapon meets the NFA’s longstanding definition, owners would not be able to establish a cognizable property interest sufficient for takings purposes. See *id.* at 1364–65 (holding that possessors of bump stocks failed to establish a cognizable property interest in continued possession in light of limitations from preexisting Federal firearm statutes that inhered in the title to their property).

In addition, the NFA’s regulations on firearms—and enforcement actions taken under that statutory authority—do not constitute Fifth Amendment takings because the Takings Clause does not apply to public safety regulations such as the NFA. As the Supreme Court has articulated, “[a] prohibition simply upon the use of property for purposes that are declared, by valid legislation, to be injurious to the health, morals, or safety of the community, cannot, in any just sense, be deemed a taking or an appropriation of property for the public benefit.” *Mugler v. Kansas*, 123 U.S. 623, 668–69 (1887). The Federal Circuit also has recognized that, under Supreme Court precedent, there are certain exercises “of the police power that ha[ve] repeatedly been treated as legitimate even in the absence of compensation to the owners of the . . . property.” *Acadia Tech., Inc. v. United States*, 458 F.3d 1327, 1332–33 (Fed. Cir. 2006). A restriction on “contraband or noxious goods” and other dangerous articles imposed by the government to protect public welfare “has not been regarded as a taking for public use for which compensation must be paid.” *Id.* at 1332.

Applying these principles, courts have rejected arguments that restrictions on the possession of dangerous firearms, like NFA firearms, are takings requiring just compensation. In *Akins v. United States*, 82 Fed. Cl. 619 (2008), the Court of Federal Claims rejected takings claims after ATF reconsidered its prior classification decisions regarding the Akins Accelerator. In 2002 and 2004, ATF provided a letter to the

manufacturer of the Akins Accelerator that stated the device is not a machinegun as defined by the NFA. *Id.* at 621. In 2006, ATF tested the Akins Accelerator for another individual and determined the device to be a machinegun for purposes of the NFA and 18 U.S.C. 922(o). *Id.* Generally, section 922(o) prohibits the possession of machineguns manufactured after May 19, 1986, with limited exceptions. Because it constituted a machinegun under the NFA, an individual could not possess or transfer the Akins Accelerator, and the plaintiff alleged a regulatory and physical taking in violation of due process. *Id.* The court explained that “[p]roperty seized and retained pursuant to the police power is not taken for a ‘public use’ in the context of the Takings Clause.” *Id.* at 622 (quoting *AmeriSource Corp. v. United States*, 525 F.3d 1149, 1153 (Fed. Cir. 2008)). In fact, courts have upheld the authority of the government to seize property through the lawful exercise of its authority, without compensation, including bump stocks. *See Maryland Shall Issue v. Hogan*, 353 F. Supp. 3d 400, 408–17 (D. Md. 2018) (rejecting takings claim arising from State ban on bump stocks), *aff’d*, 963 F.3d 356 (4th Cir. 2020); *see also Bennis v. Michigan*, 516 U.S. 442, 452 (1996) (“The government may not be required to compensate an owner for property which it has already lawfully acquired under the exercise of governmental authority other than the power of eminent domain.”).<sup>146</sup>

Even under a takings analysis, the NFA’s regulation of firearms would not constitute a physical taking, *see Horne v. Department of Agriculture*, 576 U.S. 350, 361 (2015), or a *per se* regulatory taking, *see Lucas v. S.C. Coastal Council*, 505 U.S. 1003, 1017 (1992). The statute does not compel individuals to abandon, surrender, or destroy their “stabilizing brace” devices or firearms with “stabilizing braces” attached.<sup>147</sup>

<sup>146</sup> The court in *McCutchen* suggested there may be limits on the scope of the police power, thus leaving open the possibility that, in a future case, an exercise of that power might constitute a taking. *See McCutchen*, 14 F.4th at 1363–64. Regardless of the merit of this proposition, *McCutchen* still indicates that the final rule does not constitute a taking because, as explained earlier, individuals do not have a cognizable property interest in unregulated ownership of NFA firearms.

<sup>147</sup> *See Yee v. City of Escondido, Cal.*, 503 U.S. 519, 527 (1992) (“[T]he Takings Clause requires compensation if the government authorizes a compelled physical invasion of property.”); *L.L. Nelson Enterprises, Inc. v. Cnty. of St. Louis, Mo.*, 673 F.3d 799, 806 (8th Cir. 2012) (“When a person voluntarily surrenders liberty or property, the State has not deprived the person of a constitutionally-protected interest.”); *Hinesburg Sand & Gravel Co. v. Chittenden Solid Waste Dist.*, 959 F. Supp. 652,

An individual may register the firearm in accordance with the provisions of the NFA or remove any offending characteristics to remove the firearm from the purview of the NFA (e.g., the removal and replacement of a barrel of less than 16 inches with a longer barrel). *See* section V.B of this preamble. Nor does the rule preclude all uses of the “stabilizing brace” or firearms with “stabilizing braces” attached. *See Lucas*, 505 U.S. at 1017–18 (applying the *per se* rule where all use of property is prohibited). “Stabilizing braces” may continue to be affixed on a short-barreled rifle so long as the firearm is registered, transferred, and taxed in accordance with the NFA. In fact, there are just over 641,000 short-barreled rifles registered in the NFRTR.<sup>148</sup>

Accordingly, if a court conducted a takings analysis, the rule would be analyzed and upheld under the multi-factor test for regulatory takings claims identified by the Supreme Court in *Penn Central Transportation Co. v. City of New York*, 438 U.S. 104, 124 (1978). A court applying that analysis would consider: (1) the economic impact of the regulation on the claimant, (2) its interference with investment-based expectations, and (3) the character of the governmental action. *Id.* at 124.

First, the economic impact of the rule on affected individuals will be minimal. As just explained, the rule does not require individuals to abandon, surrender, or destroy their firearms with attached “stabilizing braces”; at most, the final rule will require compliance with certain tax and registration requirements, but the Department has ameliorated the financial impact of the NFA’s taxes by forbearing from the collection of past making taxes from individuals and FFLs.

Second, an individual’s “reasonable investment-backed expectations are greatly reduced in a highly regulated field.” *Branch v. United States*, 69 F.3d 1571, 1581 (Fed. Cir. 1995); *see also McCutchen v. United States*, 145 Fed. Cl. 42, 56 (2019), *aff’d on other grounds*, 14 F.4th 1355 (Fed. Cir. 2021) (“The firearms industry is the quintessential ‘highly regulated field,’” and “[a]nyone who enters the firearms industry has to be aware that shifting public sentiments, evolving research concerning firearms availability and public safety, and events like [a] . . . mass shooting may lead to rule changes that render unlawful what was once permissible.”).

657 (D. Vt. 1997) (“A fundamental requirement for any taking is that the challenged governmental action create legal compulsion.”).

<sup>148</sup> Source: National Firearms Act Division (as of November 2, 2022).

And the Supreme Court has made clear that an owner of personal property “ought to be aware of the possibility that new regulation might even render his property economically worthless.” *See Lucas*, 505 U.S. at 1027–28. Here, the weapons potentially affected by this rule are dangerous articles that are highly regulated by the NFA and GCA, and ATF’s history of often classifying weapons with attached “stabilizing braces” as short-barreled rifles, *see* section II.B of this preamble, indicated to firearm owners the potential for future regulations that would affect individuals’ “stabilizing braces.”

Finally, a restriction “directed at the protection of public health and safety . . . is the type of regulation in which the private interest has traditionally been most confined and governments are given the greatest leeway to act without the need to compensate those affected by their actions.” *Rose Acre Farms, Inc. v. United States*, 559 F.3d 1260, 1281 (Fed. Cir. 2009). The character of the current governmental action—*i.e.*, a regulation to promote public safety—thus weighs in favor of a conclusion that the rule will not result in a taking.

#### d. Unconstitutionally Vague Under the Fifth Amendment

##### Comments Received

Commenters argued that the proposed regulations violate the Due Process Clause of the Fifth Amendment. Commenters argued that the proposed rule was “impossibly vague and arbitrary” and that none of the factors were based in Federal statute. Commenters asserted that the rule only serves “to make criminal via regulation that which the statute does not make criminal, complicate, confuse, make ambiguous and otherwise obfuscate and obstruct the industry from engaging in lawful commerce.” Specifically, one commenter stated that clarity is an essential element of the Fifth Amendment and cited to the Supreme Court case *F.C.C. v. Fox Television Stations*, 567 U.S. 239 (2012) (“*Fox*”). The commenter argued that the definition of “rifle” would be “incomprehensible,” as it would now include “firearms that are not intended by the manufacturer or designer to be fired from the shoulder[.]” and, further, that the weighted factors were also unintelligible. The commenter asserted that this ambiguity would deprive market participants and the public of notice about what the law is. Similarly, commenters stated that the proposed rule, as written, produced confusion that would make it more difficult for

law abiding citizens and businesses to comply with the regulation.

Several commenters stated the rule and the criteria ATF would rely on were subjective, arbitrary and capricious, or vague, such that that an average person could not understand the rule well enough to avoid committing a felony or understand what is required. One commenter questioned what would happen if a vendor who sold firearms equipped with a “stabilizing brace” did not resubmit the firearm and “brace” to ATF to inquire about their classification and asked how the owners of such firearms would be made aware of the new classification.

#### Department Response

The Department disagrees with commenters that the rule is unconstitutionally vague but agrees that some of the criteria on the worksheet would have been difficult for users to apply. For the reasons discussed in section IV.B.1–3 of this preamble, the rule does not adopt the proposed Worksheet 4999 or the point system. Rather, the Department is incorporating into the definition of “rifle” a list of objective design features and other factors, all of which were part of the NPRM, to better clarify when a firearm equipped with a “stabilizing brace” or other rearward attachment is designed, made, and intended to be fired from the shoulder. Knowledge of the proper inquiry and factors that ATF considers when making a classification will allow members of the firearm industry and the public to evaluate whether a weapon incorporating a “stabilizing brace” or other rearward attachment is, in fact, a short-barreled rifle subject to the NFA. The Department does not believe the listed factors are complicated, confusing, or ambiguous. The Department carefully considered the many comments it received in deciding how best to define the relevant factors. In the final regulatory text, the Department selected the critical objective design features and other factors that are necessary for determining whether a firearm is designed, made, and intended to be fired from the shoulder.

The Department disagrees with commenters that the definition of “rifle” now includes other firearms that are not intended by the manufacturer or designer to be fired from the shoulder. Under the best reading of the term “rifle” in the GCA and NFA, the term should be applied to weapons without regard for whether, when equipped with a “stabilizing brace,” they can be fired with a single hand in certain circumstances or by a particular

individual. *See United States v. Alvarez-Sanchez*, 511 U.S. 350, 356 (1994) (“When interpreting a statute, we look first and foremost to its text.”). Accordingly, the Department has concluded that ATF will examine the objective design features of each weapon and other factors to determine whether a firearm is designed, made, and intended to be fired from the shoulder. The listed criteria in this rule are mentioned and discussed in the NPRM. The Department provides further discussion on each of the factors in sections IV.B.2 and IV.B.3 of this preamble.

The Department believes the rule provides sufficient notice under the Due Process Clause of the Constitution. As an initial matter, to the extent that the commenters believe that Due Process Clause is implicated by the rule because the rule itself imposes criminal or civil restrictions, the commentators are mistaken. The relevant legal restrictions are found in the NFA and GCA, and this rule does not alter, amend, or add to those restrictions; instead, the rule informs the public of the best interpretation of the relevant statutory provisions.

The Department recognizes that clarity of legal restrictions is an essential element of the Fifth Amendment. *See Fox*, 567 U.S. 239. The Supreme Court has explained that “[a] fundamental principle in our legal system is that laws which regulate persons or entities must give fair notice of conduct that is forbidden or required.” *Id.* at 253 (citing *Connally v. General Constr. Co.*, 269 U.S. 385, 391 (1926) (“[A] statute which either forbids or requires the doing of an act in terms so vague that men of common intelligence must necessarily guess at its meaning and differ as to its application, violates the first essential of due process of law.”)). The question is “whether the text of the statute and its implementing regulations, read together, give ordinary citizens fair notice with respect to what the statute and regulations forbid, and whether the statute and regulations read together adequately provide for principled enforcement by making clear what conduct of the defendant violates the statutory scheme.” *United States v. Zhi Yong Guo*, 634 F.3d 1119, 1123 (9th Cir. 2011) (citing *City of Chicago v. Morales*, 527 U.S. 41, 56 (1999)). However, “[c]ondemned to the use of words, we can never expect mathematical certainty from our language.” *Grayned v. City of Rockford*, 408 U.S. 104, 110 (1972); *see also Ward v. Rock Against Racism*, 491 U.S. 781, 794 (1989) (“perfect clarity and precise guidance have never been required even

of regulations that restrict expressive activity”).

The Supreme Court has held that a regulatory scheme similar to the statutory and regulatory scheme discussed in this final rule is not facially unconstitutional under the void for vagueness doctrine. *See Vill. of Hoffman Ests. v. Flipside, Hoffman Ests., Inc.*, 455 U.S. 489 (1982). A local ordinance in that case required a business to obtain a license if it sold “any items, effect, paraphernalia, accessory or thing which is designed or marketed for use with illegal cannabis or drugs, as defined by Illinois Revised Statutes.” *Id.* at 492. The vagueness challenge to the ordinance “focus[ed] on the language ‘designed or marketed for use.’” *Id.* at 500. As relevant to this final rule, the Court held that the phrase “designed for use” as used in the ordinance encompassed any “item that is principally used with illegal drugs by virtue of its objective features,” and that this understanding of the term was “sufficiently clear” to withstand the vagueness challenge. *Id.* at 501. By similar reasoning, the final rule is sufficiently clear because, like the ordinance at issue in *Flipside*, it defines the relevant item on the basis of whether the objective features of the item (here, a weapon with an attached “stabilizing brace”) in consideration with other evidence listed in this rule indicate that the firearm is designed, made, and intended for a particular purpose (here, firing from the shoulder).

The Eleventh Circuit has reached a similar conclusion about a similar scheme. *See High Ol’ Times, Inc. v. Busbee*, 673 F.2d 1225 (11th Cir. 1982). The Georgia statute at issue in that case “define[d] a ‘drug related object’ as any object ‘which is designed or marketed as useful primarily for’ use with controlled substances.” *Id.* at 1230. The court construed the phrase “designed for use” to mean the intended use of the item “as manifested by the objective physical characteristics of the item.” *Id.* at 1230–31. The court then rejected a vagueness challenge to the statute, citing *Flipside* for the proposition that the standard was sufficiently clear. *Id.* at 1231. Again, then, the use of the objective physical features of an item to determine the item’s intended use—just as this final rule requires—was not unconstitutionally vague. Courts have applied similar reasoning in other contexts, including the regulation of firearms. *See, e.g., United States v. Kuzma*, 967 F.3d 959, 969–70 (9th Cir.), *cert. denied*, 141 S. Ct. 939 (2020) (rejecting a vagueness challenge to the phrase “designed to shoot . . . automatically” in the definition of



“machine gun” after explaining the inquiry turns on the relevant item’s “specific configuration of objective structural features”); *id.* at 970 (“By focusing on whether a device has a specific configuration of *objective* features that, absent a minor defect, would give it the capacity to shoot automatically, the phrase a ‘weapon which . . . is designed to shoot . . . automatically’ provides both sufficient notice as to what is prohibited and sufficient guidance to prevent against arbitrary enforcement.” (emphasis in the original)); *United States v. Biro*, 143 F.3d 1421, 1427 (11th Cir. 1998) (rejecting a vagueness challenge to a statute because the “objective characteristics” of the items at issue indicated they were “‘primarily useful for the purpose of the surreptitious interception’ of oral communications”).

The Department also believes that the meaning of the particular objective design features incorporated in this rule would be readily ascertainable. The final regulatory text first directs an individual to examine whether the firearm includes an accessory, component, or other rearward attachment (*e.g.*, a “stabilizing brace”) that provides surface area that allows the weapon to be fired from the shoulder. This language would thus give an individual fair notice that surface area is the first particular characteristic of the weapon the individual needs to evaluate. *Cf. United States v. Lim*, 444 F.3d 910, 916 (7th Cir. 2006) (NFA regulation of short-barreled shotgun not unconstitutionally vague as to the minimum length of the barrel, since the statute gave defendant fair notice of the particular characteristic that had to be measured). Next, the individual would need to identify whether the firearm incorporates other objective characteristics listed in this rule, including weight and length of the firearm as compared to the length of similarly designed rifles; sights and scopes with eye relief that require shouldering of the firearm; or length of pull consistent with similarly designed rifles (including whether there is an adjustable or telescoping attachment with the ability to lock into various positions). The rule also includes as relevant factors the intended and actual use of the firearm, including the manufacturer’s direct or indirect marketing or promotional materials and information demonstrating the likely use of the weapon in the general community. An individual would be able to determine the meaning of the terms used in the rule based on publicly available information regarding

firearms, practical application through the use of the firearm (*e.g.*, use of scopes), and the examples provided in this preamble. *Cf. United States v. Catanzaro*, 368 F. Supp. 450, 454 (Dist. Ct. 1973) (rejecting a vagueness challenge where standard firearms reference books could be used to help give meaning to statutorily defined terms).

In addition, by going through this rulemaking process, the Department has provided notice and opportunity to comment regarding the best interpretation of the statutory definition and how, in future enforcement and classification determinations, ATF intends to evaluate whether any particular weapon configuration constitutes a “rifle.” The promulgation of this rule through notice-and-comment procedures reduces vagueness concerns by providing fair notice of the definition of a “rifle.” *See Guedes v. Bureau of Alcohol, Tobacco, Firearms, and Explosives*, 920 F.3d 1, 28 (D.C. Cir. 2019); *see also Guedes v. Bureau of Alcohol, Tobacco, Firearms, and Explosives*, 520 F. Supp. 3d 51, 71 (D.D.C. 2021).

Next, to the extent that an individual is unsure about whether a particular firearm with a particular attached “stabilizing brace” constitutes a rifle, that individual is free to request a classification determination from ATF for additional clarity. Moreover, ATF is publishing information simultaneously with this rule to inform members of the public of how they might be impacted based on (1) common weapon platforms with attached “stabilizing brace” brace designs and (2) examples of commercially available firearms with “stabilizing braces” that are short-barreled rifles. For individuals with such firearms equipped with a “stabilizing brace,” actions such as registration in the NFRTR will need to be taken as discussed in section V.B of this preamble. ATF will inform the public as new weapon platforms and “stabilizing braces” or other devices become available.

#### e. Ex Post Facto Clause

##### Comments Received

Numerous commenters asserted that the rule creates an unconstitutional Ex Post Facto law in violation of Article 1, Section 9 of the Constitution. The commenters argued that customers bought “stabilizing brace” products in good faith for almost a decade. They stated that this rule is a “clear example of criminalizing activity (possessing a certain configuration of firearm) at [the] federal level (reinterpretation of the

NFA) that was not prohibited beforehand.” Similarly, other commenters deemed the proposed rule a “retroactive law,” as they believed it would retroactively declare possession of braces and braced pistols to be a serious crime even though ATF had, over the past 10 years, permitted the entry of these products into the marketplace via multiple guidance letters. Another commenter argued that the proposed rule imposes impermissible retroactive regulatory obligations, which is not favored in Federal law. To issue a retroactive rule, the same commenter argued, there needs to be an express grant of statutory authority under the NFA, which the Department does not have except in a narrow set of circumstances that are not applicable here. The commenter also cited to *United States v. Cash*, 149 F.3d 706, 707 (7th Cir. 1998), where the court stated, “the Secretary cannot give retroactive application to tax regulations.”

##### Department Response

The Department disagrees that the rule violates the Ex Post Facto Clause. In *Calder v. Bull*, 3 U.S. (3 Dall.) 386, 390 (1798), Justice Chase set out four types of laws that violate the Ex Post Facto Clause: (1) “Every law that makes an action, done before the passing of the law, and which was *innocent* when done, criminal; and punishes such action;” (2) “Every law that *aggravates* a crime, or makes it *greater* than it was, when committed;” (3) “Every law that *changes the punishment*, and *inflicts a greater punishment*” and (4) “Every law that alters the *legal rules of evidence*, and receives less, or different, testimony, than the law required at the time of the commission of the offence, *in order to convict the offender.*” (Emphases in the original.)

Citing *Calder*, the Supreme Court has explained that a “law must be retrospective—that is, it must apply to events occurring before its enactment—and it must disadvantage the offender affected by it by altering the definition of criminal conduct or increasing the punishment for the crime” to be considered as falling within the ex post facto prohibition. *Lynce v. Mathis*, 519 U.S. 433, 441 (1997) (citation and quotation marks omitted). This rule does not meet the definition of any of the four types of laws that the Supreme Court has held violate the Ex Post Facto Clause. Indeed, the rule does not itself impose any liability on any individual or otherwise regulate primary conduct. Instead, the present rule describes the proper application of the phrase “designed . . . , made . . . , and

intended to be fired from the shoulder,” as used to define a “rifle” in the GCA and NFA. See 18 U.S.C. 921(a)(7); 26 U.S.C. 5845(c). The rule does not impose liability independent of already preexisting requirements for short-barreled rifles under those statutes, *i.e.*, interstate transportation, registration, transfer and making approval, and transfer and making tax. See 18 U.S.C. 922(a)(4); 26 U.S.C. 5811–5812, 5821–5822, 5841.

In any event, courts have consistently recognized that regulating the continued or future possession of a firearm that is already possessed does not implicate the Ex Post Facto Clause because such a regulation does not criminalize past conduct. See, *e.g.*, *United States v. Pfeifer*, 371 F.3d 430, 436–37 (8th Cir. 2004); *United States v. Mitchell*, 209 F.3d 319, 322 (4th Cir. 2000); *United States v. Brady*, 26 F.3d 282, 290–91 (2d Cir. 1994); *United States v. Gillies*, 851 F.2d 492, 495–96 (1st Cir. 1988) (Breyer, J.); *United States v. D’Angelo*, 819 F.2d 1062, 1065–66 (11th Cir. 1987); see also *Samuels v. McCurdy*, 267 U.S. 188, 193 (1925) (rejecting Ex Post Facto Clause challenge to statute that prohibited the post-enactment possession of intoxicating liquor, even when the liquor was lawfully acquired before the statute’s enactment).

Moreover, the rule expressly provides options for unlicensed individuals and FFLs to comply with the requirements of the NFA if they are currently in possession of firearms equipped with a “stabilizing brace” and a barrel length of less than 16 inches that are short-barreled rifles. The Department, in its enforcement discretion, has determined that current possessors of these affected firearms have until 120 days after this rule is published to take the necessary actions, as described in this rule, to comply with Federal law to avoid civil and criminal penalties. Additionally, in an exercise of its enforcement discretion, the Department has determined that individuals and FFLs will not be liable for paying past making and transfer taxes for weapons of the sort described in this rule that are NFA firearms. For a further discussion on tax forbearance, see sections IV.B.8.e, IV.B.9.b–c, and V.C of this preamble.<sup>149</sup>

<sup>149</sup> With respect to the commenter that cited *United States v. Cash*, 149 F.3d 706, 707 (7th Cir. 1998), ATF notes that the court’s statement that “the Secretary cannot give retroactive application to tax regulations” referred to the current version of 26 U.S.C. 7805(b). As discussed below, however, the pre-1996 version of section 7805(b) applies to this rule, and that version lacks the restriction on retroactive liability. Indeed, under the pre-1996 version, “there is a presumption that every regulation will operate retroactively, unless the Secretary specifies otherwise.” *UnionBancal Corp.*

#### f. Equal Protection Clause

##### Comments Received

Numerous commenters stated that the rule has a disparate impact on women and persons with disabilities and thus violates the Equal Protection Clause. Additionally, at least one commenter cited to *Harper v. Virginia Board of Elections*, 383 U.S. 663 (1966), in which the Supreme Court held that a State’s conditioning the right to vote on the payment of a fee or tax violates the Equal Protection Clause of the Fourteenth Amendment. The commenter said that the Court held that, where “fundamental rights and liberties are asserted under the Equal Protection Clause, classifications which might invade or restrain them must be closely scrutinized and carefully confined.” *Id.* at 670. The commenter went on to state that, “[if] this is such a legal certainty, how is the imposition of taxes, registration, and other requirements on [the] individual practice of the Second Amendment right . . . not also a violation of the Equal Protection Clause of the Fifth Amendment where the Federal Government is concerned?”

##### Department Response

The Department disagrees that the rule violates the Equal Protection Clause. As an initial matter, the rule itself does not require the payment of any fees or taxes, nor does the rule itself directly regulate firearms. Instead, the rule does no more than articulate the best interpretation of the relevant statutory provisions.

Moreover, it is well established the “Equal Protection Clause forbids only intentional discrimination.” *Horner v. Ky. High School Athletic Ass’n*, 43 F.3d 265, 276 (6th Cir. 1994). Even if “a neutral law has a disproportionately adverse effect . . . , it is unconstitutional under the Equal Protection Clause only if that impact can be traced to a discriminatory purpose.” *Personnel Administrator of Massachusetts v. Feeney*, 442 U.S. 256, 272 (1979); see also *Soto v. Flores*, 103 F.3d 1056, 1067 (1st Cir. 1997) (“It is a truism that under Equal Protection Clause jurisprudence, a showing of disproportionate impact alone is not enough to establish a constitutional violation.”). “Discriminatory intent” requires that the “decisionmaker selected or reaffirmed a particular course of action at least in part ‘because of,’ not merely ‘in spite of’ the law’s differential treatment of a particular class of persons.” *SECSYS, LLC v. Vigil*,

*v. Comm’r*, 113 T.C. 309, 327 (1999), *aff’d*, 305 F.3d 976 (9th Cir. 2002).

666 F.3d 678, 685 (10th Cir. 2012) (Gorsuch, J.) (alteration and some quotation marks omitted) (citing *Feeney*, 442 U.S. at 279). Consequently, “when the law under review is generally applicable to all persons, no presumption of intentional discrimination arises; proof is required. This is so because many laws, perhaps most and often unavoidably, affect some groups of persons differently than others even though they involve no *intentional* discrimination.” *Id.* (Emphasis in the original.)

Both the NFA and this final rule are generally applicable to all persons. Neither the NFA nor this rule creates discrete, objectively identifiable classifications of similarly situated individuals that are intentionally treated differently under its provisions. See *San Antonio Indep. Sch. Dist. v. Rodriguez*, 411 U.S. 1, 60 (1973) (Stewart, J., concurring); *Tex. Entertainment Ass’n v. Hegar*, 10 F.4th 495, 513 (5th Cir. 2021); *Corey Airport Servs., Inc. v. Clear Channel Outdoor, Inc.*, 682 F.3d 1293, 1296–97 (11th Cir. 2012) (“[N]o valid equal protection claim exists” in the absence “of a discrete and identifiable group to which [the plaintiff] belonged and which the [government] treated in a discriminatory, prejudicial manner” under a “governmental classification.”).

Moreover, contrary to commenters’ assertions, the Department doubts that this rule will have a disparate impact on women and persons with disabilities. The Department has no evidence that women or persons with disabilities are disproportionately affected by the rule’s definition of rifle, and commenters have not provided any. In any event, the rule does not prohibit ownership of a firearm equipped with a “stabilizing brace”; instead, it only requires lawful registration in the NFRTR of those combinations of firearms and “braces” that meet the statutory definition of an NFA “firearm.” And even assuming that this rule does impact some groups differently, the rule—as just stated—runs afoul of the Equal Protection Clause only “if that impact can be traced to a discriminatory purpose.” *Feeney*, 442 U.S. at 272. Here, there is no such purpose.

Next, even if the NFA or this rule did implicate equal protection principles, the Department disagrees that the NFA’s regulatory scheme violates the Equal Protection Clause. If a “classification ‘impermissibly interferes with the exercise of a fundamental right or operates to the peculiar advantage of a suspect class,’ [a court will] subject the classification to strict scrutiny. Otherwise, [courts] will uphold the classification if it is ‘rationally related to

a legitimate state interest.’’ *Mance v. Sessions*, 896 F.3d 699, 711 (5th Cir. 2018) (citing *NRA v. ATF*, 700 F.3d 185, 211–12 (5th Cir. 2012)). As discussed above, there is a fundamental right to own firearms, but the Court in *Heller* noted the right is not absolute or unlimited. 554 U.S. at 595. In *Heller*, the Supreme Court specifically recognized an “important limitation on the right to keep and carry arms,” and the Court stated that this limitation is supported by “the historical tradition of prohibiting the carrying of ‘dangerous and unusual weapons.’” *Id.* at 627. Because this regulation does not implicate the right protected by the Second Amendment as described by the Court in *Heller*, a court would likely review this regulation under a rational basis test. Under rational basis review, a classification “is accorded a strong presumption of validity.” *Heller v. Doe by Doe*, 509 U.S. 312, 319 (1993). “The firearm regulatory scheme . . . is consonant with the concept of equal protection embodied in the Due Process Clause of the Fifth Amendment if there is some rational basis for the statutory distinctions made . . . or . . . they have some relevance to the purpose for which the classification is made.” *Lewis v. United States*, 445 U.S. 55, 65 (1980) (quotation marks omitted). There is clearly a rational basis for requiring accurate classifications and regulation of weapons. Congress, when enacting the NFA, was concerned “mainly with clearly identifiable weapons which were the cause of increasing violent crime and which had no lawful uses.” *United States v. Posnjak*, 457 F.2d 1110, 1116 (2d Cir. 1972). If a “stabilizing brace” has such a transformative effect on a pistol that the weapon’s overall configuration becomes a short-barreled rifle, then the NFA applies. Hence, the NFA’s regulation of firearms, and its application of those statutory requirements to weapons equipped with a “stabilizing brace,” has a more than rational basis.

The Department disagrees with the commenters that cited *Harper v. Virginia State Board of Elections*, where the Supreme Court held that a “State violates the Equal Protection Clause of the Fourteenth Amendment whenever it makes affluence of the voter or payment of any fee an electoral standard.” 383 U.S. at 666. The Court in *Harper* held that, “[t]o introduce wealth or the payment of a fee as a measure to a voter’s qualifications is to introduce a capricious or irrelevant factor.” *Id.* at 668. *Harper* is distinguishable because Congress passed the NFA to regulate dangerous and unusual weapons, and

the Supreme Court in *Heller* recognized that there is no fundamental right to the possession of such weapons. 554 U.S. at 627. Thus, unlike the fee imposed to vote in *Harper*, the taxes imposed under the NFA do not infringe on an individual’s fundamental right. Rather, the NFA tax is a rational mechanism to control the making and transfer of dangerous and unusual firearms that are concealable and capable of more damage than other firearms. See *Marzarella*, 614 F.3d at 90–95.

## 5. General Impact of the Rule

### a. Punishes Law-Abiding Citizens

#### Comments Received

Related to the Ex Post Facto law comments, many commenters believed that this rule will make millions of law-abiding Americans felons overnight. Commenters stated the new rule would make each and every “stabilizing brace” worthless and possession of such a “brace” would become a felony if not registered. Commenters also stated that, if promulgated, the rule would impact at least three million law-abiding citizens and threaten millions of citizens with prison, harsh fines, and forfeiture of firearms or make them felons. One commenter claimed that the rule would “have the effect of creating an altogether new crime—one that may sweep up law-abiding gun owners based on actions they already took in full conformity with the law as it existed at the time.” Another commenter believed the proposed rule would needlessly subject tens of millions of Americans’ personally identifiable information (“PII”) to the NFRTR, “which would further endanger each individual from a data privacy and security perspective.”

#### Department Response

The Department disagrees with the assertions that this rule is intended to or will make felons of law-abiding citizens. This rule does not itself impose any new restrictions; instead, this rule articulates the best interpretation of the relevant statutory terms. Nothing in this rule changes those underlying statutory requirements. Nor does this rule affect “stabilizing brace” devices alone. Further, the Department disagrees with the comment that three million law-abiding citizens will be subject to harsh fines and forfeiture of firearms. Commenters with these objections failed to recognize that nothing in the rule or the relevant statutes prevents an individual from continuing to possess or use a “stabilizing brace” on heavy pistols or rifles. This rule only serves to clarify that certain weapons equipped with “stabilizing braces” are short-

barreled rifles regulated under the NFA, thus requiring registration, transfer and making approval, and the payment of a making or transfer tax.

Furthermore, this rule also provides options for individuals who are in possession of a firearm equipped with a “stabilizing brace” that is an unregistered short-barreled rifle, as that statutory term is properly understood. The options for current unlicensed possessors include the removal and replacement of the offending feature (the barrel less than 16 inches); submission of an ATF E-Form 1 by May 31, 2023, to register the firearm as a short-barreled rifle; removal of the “stabilizing brace” so that it cannot be reattached to the firearm; turning the firearm into a local ATF office; or destroying the firearm. For a detailed discussion of the options available for individuals to comply with the statute, see section V.B of this preamble. In an exercise of the Department’s enforcement discretion, it has determined that any criminal liability for failure to take the necessary action to comply with Federal law for weapons that have already been made will result only for conduct occurring after the time period to register ends. Additionally, in lieu of criminal prosecution, the Department may, for conduct occurring after the 120-day period, pursue forfeiture of the firearm pursuant to 26 U.S.C. 5872.

The Department also disagrees this rule needlessly harms citizens by risking exposure of PII. The NFA requires that the registry of NFA firearms in the NFRTR include the identification of the firearm, date of registration, and identification and address of person entitled to possession of the firearm. See 26 U.S.C. 5841. The information in the NFRTR is confidential, and ATF officers or employees and other persons are prohibited by law from disclosing confidential NFA tax information. See 26 U.S.C. 6103. This provision of Federal law applies to all officers and employees of the United States and other persons with access to excise tax returns or tax return information. Further, regulations also generally prohibit disclosure of ATF records or information, and, if records are to be disclosed, the regulations specify disclosure methodology and requirements. See 27 CFR 70.803. Criminal penalties for disclosing this information include a fine, imprisonment up to one year, or both, and dismissal from employment. 18 U.S.C. 1905. The regulations also provide for criminal penalties and



dismissal for violations. *See* 27 CFR 70.803(g).

b. Purchasers Unaware of Legal Issues  
Comments Received

Commenters believed it was unfair that ATF would go back on its word after a decade in which millions of weapons with an attached “stabilizing brace” were bought and sold and now try to crack down on them. Commenters felt manufacturers have been working with the ATF for years to try to be compliant. The commenters believed that ATF, on the other hand, has just kicked the issue down the road without giving manufacturers and law-abiding Americans straight answers about the use of “stabilizing braces.” Commenters claimed ATF not only advised that “braces” were legal, but at one point informed the public that shouldering accidentally was legal. Several commenters argued that owners of firearms with an attached “stabilizing brace” were not aware of the legal issues when they made the purchases in the past 10 years. Some commenters stated that they purposefully chose the firearm with a “stabilizing brace” because ATF recognized them as pistols. Commenters

stated that Americans do not want to go to jail just because a product that was legal is suddenly declared illegal based on an arbitrary decision by ATF leadership.

Department Response

The Department agrees that there has been confusion generated from inconsistent classifications since the initial “stabilizing brace” classification and subsequent classifications after 2012 but disagrees with commenters’ implication that ATF “approved” all “stabilizing braces” for use on AR-style pistols (or other similarly heavy pistols). While firearm manufacturers are not required to submit a firearm to ATF for classification under Federal law prior to marketing those firearms, many do so because it helps them to anticipate how their firearm will be regulated under the law. As discussed earlier, ATF received and responded to several classification requests for how a “stabilizing brace” device impacts a firearm’s classification under Federal law.

Additionally, after the initial response in 2012, ATF observed the marketing of various new “stabilizing braces” that had additional features such as

adjustability, greater surface area, and increased length of pull. As an example, one “brace” manufacturer sold at least 18 models of “stabilizing brace” products as “ATF compliant,” when in fact ATF provided classifications for only 2 “brace” models for this manufacturer. Further, ATF specifically requested that this manufacturer stop marketing these additional models as ATF compliant beginning in July 2018.<sup>150</sup> While the Department recognizes there have been inconsistencies in firearms classifications that have generated confusion over time, ATF has never taken the position that any “stabilizing brace” may be equipped on a firearm without evaluating the objective design features of the firearm. Such a position would lead to the illogical result that anything that purports to be a “stabilizing brace” makes a firearm a pistol regardless of the objective design features of the firearm. For example, were ATF to accept this position, a large .50 caliber firearm, as pictured below, would fall outside the definition of a “rifle” solely because of the attached “stabilizing brace.”

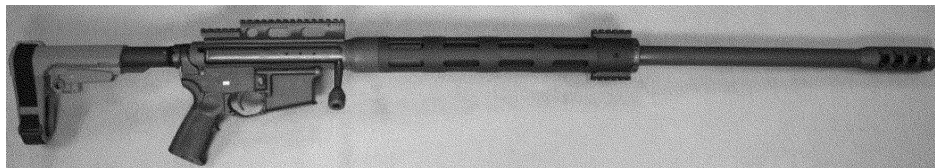

**SBA3 “Stabilizing Brace” Attached to a .50 BMG Rifle**

Based on the relevant statutory provisions, FATD classifies firearms based on the objective design characteristics of a particular firearm configuration as presented, as well as other evidence listed in this rule that may reflect the intended use of the weapon. And FATD has consistently noted that a “stabilizing brace” could design or redesign a firearm to be fired from the shoulder based on the objective features of the firearm as configured. Further, in December 2018, ATF determined that firearms equipped with “stabilizing braces” must be classified based on the overall configuration of the weapon.<sup>151</sup> As set forth in this rule, each firearm equipped with a “stabilizing brace” device will be classified based on the objective design features described in this rule, the manufacturer’s direct and indirect marketing materials, and information

demonstrating likely use by the general community. This evidence will be used to verify the manufacturer’s purported intent regarding the use of the weapon.

The Department recognizes that some purchasers may have been unaware of the legal issues when first acquiring a “brace” and affixing it to their firearm or acquiring a firearm equipped with a “stabilizing brace.” However, in light of marketing materials, industry reviews, and general public use of firearms equipped with “stabilizing braces,”<sup>152</sup> many users of firearms equipped with “stabilizing braces” likely are aware of the legal controversies surrounding these devices. *See* section IV.B.1.c, and IV.B.3.c of this preamble. At the same time, ATF also put out an Open Letter in 2015 and a response letter regarding the 2015 Open Letter in 2017, which were widely available to the public and discussed the use and impact of

“stabilizing braces” on a firearm’s classification under the NFA. These actions put the public on notice that there were questions within the firearms industry and community regarding classification issues related to firearms with “stabilizing braces.”

Furthermore, the NPRM published in June 2021 provided notice to the public that the Department would be resolving the confusion surrounding how ATF evaluates whether a firearm equipped with a “stabilizing brace” is a rifle or short-barreled rifle under the NFA and GCA. And this rule informs the public of the best interpretation of the relevant statutory definitions in determining whether a firearm with a “stabilizing brace” is designed, made, and intended to be fired from the shoulder. The rule further informs the public of options for individuals currently in possession of a firearm with a “stabilizing brace” that is

<sup>150</sup> Letter from ATF #311123 (Mar. 3, 2020); Letter from ATF #308999 (July 18, 2018).

<sup>151</sup> *See supra* section II.B and note 57.

<sup>152</sup> *See supra* notes 87–94 and 96–98.

a short-barreled rifle. For example, so long as an affected person files the relevant E-Form 1 by May 31, 2023, the Department will permit a safe harbor period between the date on which a person's application for registration is filed and the date a person receives ATF approval or disapproval of the application. Provided the registration form is properly submitted and documented, the Department, in an exercise of its discretion, will refrain from any enforcement of the NFA's provisions during this time period. Any penalties for non-compliance with NFA regulations would only be assessed on individuals who possess or transfer unregistered short-barreled rifles in the future. These penalties may include criminal penalties, tax liability, or forfeiture of the firearm.

### c. Political Motivation

#### Comments Received

Many commenters believed that the rationale for the proposed rule was politically motivated. As one commenter said, the current presidential administration feels it has the "political cover to take action in this manner." Another commenter stated that this is "not the proper way to conduct administrative guidance, where something is legal, then suddenly illegal, based on shifting political winds." Furthermore, other commenters said the only thing that has changed is the "political climate," not the law the ATF is interpreting." One commenter stated that the "lack of data or even rational arguments simply proves that this entire rule is politically motivated." Another commenter stated that "[t]he Biden Administration, via the [ATF], is once again taking aim at the Second Amendment." One commenter stated that the proposed rule was "political posturing" dressed up as a regulation that ATF should not issue. The commenter thought ATF should try to more effectively carry out its existing responsibilities and refrain from inhibiting the freedom of the people. Other commenters thought the proposed rule made ATF look foolish and partisan.

#### Department Response

The Department disagrees that the rationale for this rule is improper or politically motivated in the pejorative sense apparently used by some commenters. The Department notes that both the previous administration and this administration took and continue to take actions to notify the public of the factors considered in the classification of firearms equipped with a "stabilizing

brace." See section II of this preamble. Moreover, "Presidential administrations are elected to make policy. And as long as the agency remains within the bounds established by Congress, it is entitled to assess administrative records and evaluate priorities in light of the philosophy of the administration." *Guedes v. ATF*, 920 F.3d 1, 34 (D.C. Cir. 2019) (alteration and quotation marks omitted). Thus, even if a rule is "politically motivated" to the extent that a presidential administration's policies can inform which problems an agency seeks to most urgently address, that fact does mean the rule is motivated by, for example, animus towards the Second Amendment, as some comments seemed to suggest.

Next, as stated in the NPRM, ATF's publicly known position is that a firearm does not evade classification of the NFA merely because the firearm is configured with a device, including a device marketed as a "stabilizing brace." The use of a "stabilizing brace" cannot be used as a tool to circumvent the NFA's registration, transfer, and tax requirements or the GCA's interstate transportation restrictions surrounding short-barreled rifles. The Department considers this rulemaking necessary to clarify the best interpretation of when a weapon is designed, made, and intended to be fired from the shoulder in light of the proliferation of various "stabilizing brace" models that, when assembled on firearms, design the firearm to be fired from the shoulder, as well as the misuse and misapplication of ATF classification letters as earlier discussed. Further, the Department is responding to past criticism that ATF has not more widely published criteria and for not publishing a definitive approach. See, e.g., Letter for William Barr, Attorney General, and Regina Lombardo, Acting Director, ATF, from Matthew Gaetz, United States Representative, *et al.* (June 16, 2020). Lastly, the Department disagrees that it provided no data to justify this rulemaking. The NPRM noted that firearms equipped with a "stabilizing brace" have been used in at least two mass shootings, with the shooters in both instances reportedly using the "brace" as a shoulder stock. 86 FR at 30828. This rule, in section IV.A.2 of this preamble, also notes the prevalence of firearms with "stabilizing braces" being connected to criminal investigations.

### d. Need for "Stabilizing Braces"

#### i. Disabled Persons/Elderly/Different Body Shapes

##### Comments Received

Many commenters stressed that "stabilizing braces" are commonly used by millions of law-abiding Americans for various reasons. Commenters disagreed with the characterization that heavy or large pistols could be fired with one hand, asserting that the inability to do so is one reason that "stabilizing braces" are a popular accessory to add onto pistols. One commenter questioned ATF's claim that in the NPRM that pistols that fall below the weight and length threshold are easily fired one-handed. Another commenter said the rule did not accurately reflect the difficulty in aiming different weapons and did not account for the range of weapons different people can and cannot aim with one hand.

Numerous other commenters pointed out the use and need of "braces" by persons with disabilities or with limited mobility or strength. Some commenters described the devices as being used to assist in shooting large pistols safely by distributing the weight of the pistol to the firearm. Others also described the device as becoming "an extension of the user's forearm such that the user may actually release his or her grip from the handgun to relax." (Emphasis omitted.) Commenters also felt that this rule "ignored the features of "stabilizing braces" that are beneficial to the disabled community because it would make the devices less available to such individuals. One commenter, a former firearms instructor, stated that he taught for years the proper use of "braces" for those who were disabled or for those with less mobility. He thought that ATF missed the mark when classifying the "braced" firearms as short-barreled rifles if the brace was used correctly. Another commenter appeared to claim that the "brace" has safety benefits when he stated that attachments can protect a shooter's off hand from being placed in front of the barrel and do not, in and of themselves, redesign a pistol to be fired with more than one hand.

In contrast, one commenter claimed that he was part of the team that designed and submitted the first "stabilizing brace," and that their intent had nothing to do with assisting disabled individuals. Rather, the commenter claimed their intent was to provide for a proper means of firing a large frame pistol with one hand and that the "brace" was not intended to attach to the shooter's body.

Numerous other commenters also stated ATF had not considered the variations in the size and shape of the human body. In particular, some commenters claimed the rule ignored that individuals are physically unique and would require different settings to optimize support and comfort. One commenter protested the lack of an exemption for disabled and smaller-sized persons who, according to the commenter, have clear and legitimate needs for use of stabilizing braces.

#### Department Response

The Department disagrees that the rule will prevent people from acquiring “stabilizing braces” or restrict the use of “stabilizing braces” on firearms to assist or aid the shooter in single-handed firing of heavy pistols. To the extent that the objective design features and other evidence, as listed in this rule, regarding a particular “stabilizing brace” device attached to a weapon do not indicate that the weapon is designed, made, and intended to be fired from the shoulder, that configuration is not a firearm within the meaning of the NFA (and also not a “short-barreled rifle” under the GCA); hence, the weapon is not subject to those statutes’ restrictions. Additionally, a firearm equipped with a “stabilizing brace” may include a barrel of more than 16 inches in length and thus not be regulated as a “short-barreled rifle.” Accordingly, even if variations in strength and body type, as discussed by commenters, may make the use of a “stabilizing brace” more beneficial to certain individuals, those individuals may still be able to obtain “stabilizing braces” and affix them to a firearm without making a short-barreled rifle under the NFA and GCA. And, to the extent that any particular configuration does fall within the scope of the NFA and the GCA, possession of that weapon remains legal so long as the owner of the weapon complies with the statutes’ restrictions. However, a “stabilizing brace” device cannot be used to circumvent the NFA by permitting the possession of unregistered short-barreled rifles. This rule does not provide any additional restrictions on the use of a “stabilizing brace” on any rifle configurations beyond those provided by the relevant statutes. All individuals may register their firearm with an attached “stabilizing brace” that is a short-barreled rifle in the NFRTR or modify the firearm so it no longer constitutes a short-barreled rifle.

#### ii. Shooting Accuracy and Safety Comments Received

Many commenters stated that stabilizing braces make shooters more accurate. A commenter stated that, by putting a brace on a regular size pistol, one-handed shooting can be made more accurate and enjoyable. One commenter stated that, although braces were originally developed for use by disabled persons, “[b]oth disabled and non-disabled persons now use stabilizing braces as an additional point of support to ensure firearm safety and accuracy in operation of pistols and shotguns.” Likewise, another commenter asserted that braced pistols are more accurate and less dangerous than unbraced pistols, and that the attachment of a “brace” device makes it less likely that the pistol will be used for violence. One commenter contended that the rule does not take into account the actual intent of the person with the firearm, who may want a brace on a light-weight pistol because the person is weak, wishes to use it for accuracy, or for some other reason.

In addition, many commenters disagreed with ATF’s repeated characterization that pistols are fired using only one hand. Commenters indicated that it is typical for shooters to hold a pistol with two hands and that people are taught to shoot this way or may need to shoot that way depending on their shooting ability. Another commenter said “[j]ust because a handgun is statutorily defined as a firearm intended to be fired by the use of a single hand does not exclude other firearm types from using a stabilizing brace which *can* be fired in that manner.” (Emphasis in the original.)

#### Department Response

The Department acknowledges that some individuals typically use two hands to hold and shoot pistols and that holding a pistol with two hands can make shooting more accurate or enjoyable. The fact that the “stabilizing brace” makes firing a standard pistol more accurate or more enjoyable is irrelevant. Regardless of a particular individual’s intent to fire a firearm with one hand, the relevant inquiry under the best interpretation of the statutory provisions is whether the objective design characteristics and other evidence associated with a firearm configured with the “stabilizing brace” indicate that the firearm is designed, made, and intended to be fired from the shoulder. Again, this rule does not regulate or prevent the use of “stabilizing brace” devices themselves but outlines factors that ATF will

consider when determining if a firearm equipped with a “stabilizing brace” is a rifle or short-barreled rifle regulated by the NFA and GCA.

#### e. State Prohibitions of Short-Barreled Rifles

##### Comments Received

Some commenters pointed out that some States prohibit the possession of short-barreled rifles, and they asserted that owners of “braced” firearms classified as short-barreled rifles would, as a result, be forced to relinquish their firearms.<sup>153</sup> A commenter claimed ATF failed to address situations where attachment of a 16-inch or longer barrel may not remedy the unlicensed possessors being in violation of State law because the resulting firearm with a 16-inch barrel would be a prohibited “assault weapon” under State law. Such comments suggested that classifying a “braced” weapon as a short-barreled rifle could result in a situation in which the individual may not retain the firearm, nor could they modify the firearm with a longer barrel. Retaining the firearm would amount to illegal possession of a short-barreled rifle banned by State law; and modifying the weapon would result in possession of an assault weapon banned by State law. Additionally, some individuals, according to commenters, may not have the ability to reconfigure a “braced” weapon to also comply with State or local laws. In such scenarios, individuals would likely have no other option but to turn the firearm in to ATF or local law enforcement.

##### Department Response

The Department disagrees that it is required to provide additional options for individuals who may be in violation of State law. The Attorney General is

<sup>153</sup> Commenters concerned about the application of State law seemed to assume at times that the Federal definition of “rifle,” as clarified in this rule, would change the way in which State laws are applied to their firearms. This is not necessarily the case. Even when a State law uses the same word—such as “rifle”—as does Federal law, the States’ specific definitions and interpretations of the words in their statutes may differ from Federal definitions and Federal interpretations of Federal law. *Cf. Molina v. I.N.S.*, 981 F.2d 14, 19 (1st Cir. 1992) (Breyer, J.) (observing that nothing “prevent[s] federal legislative authorities from writing federal statutes that differ from state statutes or from attaching, to words in a federal statute, a meaning that differs from the meaning attached to the same word when used in a statute enacted by a state”). Hence, this rule may have no effect on how States determine what sort of weapons are “rifles” for purposes of State law. Nonetheless, the Department acknowledges the concerns raised by commenters, and, in order to ensure a comprehensive consideration of the possible effects of this rule, the Department has accounted for commenters’ concerns in its final regulatory impact analysis and in finalizing this rule.



responsible for both the criminal and regulatory enforcement of the GCA and NFA as delegated to ATF. Therefore, ATF uses Federal law, specifically the GCA and NFA, to govern the classification and regulation of firearms. Although the Department has considered the potential federalism implications of this rule under Executive Order 13132 (Federalism), as discussed in section VI.B of this preamble, it has determined that the rule will not have significant federalism implications. Moreover, that Executive Order focuses on the “direct” effects of Federal law on the relationship and distribution of power between the States themselves and the Federal Government, not whether a change in Federal law may have incidental effects for individuals as a consequence of State laws where those individuals reside. Accordingly, the Department is not required to further account for how its firearm classification affects State laws.

In this rule, the Department provides several options to current unlicensed possessors of firearms equipped with a “stabilizing brace” and a barrel length of less than 16 inches that are properly classified as a short-barreled rifle under the NFA. These options, discussed in section V.B of this preamble, are provided so that persons in possession of a short-barreled rifle may comply with Federal law. The Department recognizes that a State may pass a law or have laws that further restrict the possession of certain firearms, including those that fall under the purview of the NFA. The Department understands that abandonment of the firearm may be the only option available for some individuals to come into compliance with State law, but the options discussed in this rule will allow many individuals to avoid this outcome. For example, an individual may remove any offending characteristics to remove the firearm from the purview of the NFA (*i.e.*, permanent removal of the “stabilizing brace” or the removal and replacement of a barrel of less than 16 inches with a longer barrel). Making these kinds of modifications will bring a firearm outside the scope of the NFA. Thus, in States where firearms laws are coextensive with the NFA, individuals will be able to continue possessing the firearms.

The Department also acknowledges that some States may regulate a firearm with 16-inch or longer barrel as an assault weapon under State law. However, the Department still believes there are methods available for individuals to comply with these States’ laws. For example, an individual can

remove the “stabilizing brace” such that it cannot be reattached, and the individual could possess the resulting pistol consistent with the requirements of their State law. The Department recognizes that the removal of a “stabilizing brace” from a firearm that was originally received as a “short-barreled rifle” would cause the firearm to become a “weapon made from a rifle” as defined by the NFA. However, the Department, in its enforcement discretion, will allow individuals to reconfigure the firearm to a pistol, so long as the reconfiguration is completed within 120 days after this rule is published. This reconfiguration may bring the firearm into compliance with State law even if the State restricts possession of short-barreled rifles. It may also be possible for the individual to consider other modifications to the firearm that are not included within this rule that would bring the firearm into compliance with State law.

In a narrow set of circumstances in which the individual cannot remove the “brace” device and maintain the pistol, or make other modifications to the firearm, then the firearm may be prohibited under State law and must be either destroyed or disposed of in compliance with State law. The Department notes that commenters did not appear to submit information indicating the frequency with which such circumstances would arise, and ATF’s experience indicates that these circumstances would be extremely limited. The Department thus believes that the important public safety benefits of this rule, as discussed more fully in the accompanying Regulatory Impact Analysis (“RIA”), outweigh any interest in retaining the firearm for the few individuals who might find themselves in such circumstances. Information regarding the application of State law to a particular weapon would be within the jurisdiction of the State agency responsible for the enforcement of the State firearms laws or other State legal authority.

#### 6. NFA Wait Times

##### Comments Received

Commenters raised a variety of issues related to the NFA registration and tax requirements. Regarding the imposition of NFA registration, many commenters expressed concern over the burden of completing paperwork, which may necessitate submission of sensitive personal information for property they have already lawfully purchased. Additionally, many commenters expressed concern with the timeframe to receive approval, which ranges from

many months to even a year. Some commenters did not think that ATF has the capability to handle the volume of NFA applications this rule will generate. To relieve such a burden, commenters recommended expediting the processing of applications for the impacted firearms, with some recommending expediting processing of any NFA applications to within 30 days. One commenter recommended that there be a grace period to ensure that firearms with attached “stabilizing braces” are not confiscated while in the process of receiving approval from ATF.

##### Department Response

The Department acknowledges that this rule will likely increase NFA registrations as individuals decide to register the weapons that they previously treated as pistols, but which, as this rule clarifies, are actually short-barreled rifles. These firearms were sold or otherwise transferred to persons without complying with the tax, registration, and transfer provisions of the NFA. The Department disagrees that, by allowing possessors of short-barreled rifles equipped with a “stabilizing brace” to register their firearm, this rule creates additional overly burdensome paperwork for individuals. ATF will be using the Form 1, which is already used as the application to make and register an NFA firearm. Furthermore, ATF has plans to increase and adjust its resources to accommodate the increase in applications.

Moreover, affected parties who wish to register their NFA firearm should use ATF’s eForms system in order to comply with Federal law.<sup>154</sup> Individuals will need to create an ATF eForms account on <https://eforms.atf.gov> to submit the E-Form 1 electronically. The eForms system will have instructions and will guide the applicant through the application process. While using the eForms system is a convenient and easy way for persons to submit their E-Form 1 applications, the Department cannot expedite the E-Form 1 applications received on this rule because of the need to continue processing existing NFA applications, as well as the required National Instant Criminal Background Check System checks that must be conducted on the applicant to verify the individual is not prohibited

<sup>154</sup> For purposes of this rule, ATF advises that affected parties use the eForms system to lessen the administrative burden in registering firearms affected by this rule. However, ATF will still accept a paper submission of a Form 1 so long as it is postmarked by May 31, 2023.

from possession of an NFA firearm under Federal law.<sup>155</sup>

The Department notes that NFA processing times continue to decline as efficiencies and technology improve. ATF is also currently applying additional overtime resources and will be providing an increased level of support and effort to ensure the processing of eForm applications. Nevertheless, due to the anticipated volume, there still may be a significant waiting period before a person receives final approval and registration of their short-barreled rifle in the NFRTR. However, so long as an affected individual submits an E-Form 1 application by May 31, 2023, the Department will, in its enforcement discretion, allow these persons to temporarily possess their firearms equipped with “stabilizing braces” that are unregistered short-barreled rifles until they receive a response from ATF on their application. After the submittal of the E-Form 1, individuals will receive a receipt; the receipt should be maintained until the individual receives a tax stamp. See section V.B of this preamble below.

After the 120-day period, registration of preexisting short-barreled rifles equipped with a “stabilizing brace” will no longer be permitted. Any person in possession of an affected short-barreled rifle for which a registration has not been submitted to ATF within the defined time period is in violation of the NFA, and ATF may take enforcement action.

ATF will similarly allow Type 7 FFLs with an SOT to submit an E-Form 2 to register the firearms in their possession before May 31, 2023. See section V.B–C of this preamble for further discussion on the options for affected parties.

#### 7. Other Priorities and Efficiencies Comments Received

Some commenters stated that ATF should focus on other priorities besides the current rulemaking. Several commenters opined that alcohol and tobacco have taken far more lives than the “rifles” in question, and that should ATF focus on these issues. Other commenters, while thanking ATF and DOJ employees for their work, opined that ATF should “stay out of [their] lives” and focus on prosecuting actual criminals who are committing crimes.

<sup>155</sup> The National Instant Criminal Background Check System (“NICS”) is managed by the Federal Bureau of Investigation. When ATF submits a request for a NICS check, the FBI is responsible for issuing a Proceed,” “Delayed,” or “Denied” determination. 28 CFR 25.1, 25.6.

#### Department Response

The Department disagrees that it should withdraw the current rulemaking and focus only on other enforcement priorities. The Attorney General is responsible for both the criminal and regulatory enforcement of the GCA and NFA as delegated to ATF. See section IV.B.1.a of this preamble. The NFA requires that all “firearms” as defined by statute, including short-barreled rifles, must be registered in the NFRTR. Due to the misconception that any firearm equipped with a “stabilizing brace” is a pistol, and due to incorrect classifications involving these firearms in the past, a number of these firearms equipped with a “brace” device that are short-barreled rifles are not registered in the NFRTR in violation of Federal law. Therefore, this rule is directly within and a part of ATF’s enforcement authority and priorities. Further, although other matters may also fall within the scope of ATF’s authority, “an agency has broad discretion to choose how best to marshal its limited resources and personnel to carry out its delegated responsibilities.” *Massachusetts v. E.P.A.*, 549 U.S. 497, 527 (2007). The Department has determined in exercising this discretion that the public safety benefits accruing from this final rule make it appropriate to issue the final rule instead of withdrawing it to focus on other issues.

#### 8. Economic Comments

##### a. Need for Federal Regulatory Action Comments Received

One commenter suggested that ATF publish “only such regulations as are required by law, are necessary to interpret the law, or are made necessary by compelling public need” (quotation marks omitted), and that ATF’s negative externality explanation was “odd.” This commenter asserted that ATF did not clearly identify the problem that it is trying to address with this regulation, and that there is no statute that specifically prohibits firearms with attached “braces.” Finally, this commenter stated that ATF should analyze whether the existing laws and regulations contributed to the problem this regulation is trying to address, and whether a statutory amendment would better achieve the intended goal of the rule. Another commenter stated that ATF failed to include an analysis of the cause of the problem, failed to include a cost-benefit analysis of the proposed solution, and did not draft a regulation that is narrowly tailored to address the relevant problem.

#### Department Response

The Department reiterates that publishing this rule is necessary to ensure the public’s awareness of the Department’s best interpretation of the relevant statutory provisions and to ensure that all forms of short-barreled rifles are being regulated under the NFA and GCA, regardless of whether they result from the firearms being configured with typical shoulder stocks or with purported “stabilizing braces.”

The Department agrees that there may be confusion about ATF’s statement regarding the externality of the rule; therefore, the final regulatory analysis does not discuss externalities. For more details regarding the need for regulation, please refer to sections IV.A.2 and IV.B.1.c of this preamble.

The Department believes Congress intended for ATF to regulate certain weapons under the NFA that Congress deemed unusually dangerous. While there are no existing statutes or regulations that explicitly regulate firearms equipped with “stabilizing braces,” such weapons may nonetheless fall within the scope of the NFA and GCA. ATF is updating its regulations to make clear that firearms equipped with an accessory such as a “stabilizing brace” or other rearward attachment with the objective design features of a firearm designed, made, and intended to be fired from the shoulder are properly captured under the NFA and GCA definition of “rifle.” Furthermore, the NFA regulates short-barreled rifles by requiring registration of the firearm and payment of NFA taxes. The rule will ensure that firearms equipped with “stabilizing braces” that are designed, made, and intended to be fired from the shoulder and that have a barrel of less than 16 inches will be properly classified as short-barreled rifles under the NFA or GCA. The Department declines to analyze whether a change in statute would better achieve the goals of this rulemaking because such a change is beyond the Department’s authority.

The Department disagrees with commenters’ assertion that ATF did not analyze the cause of the problem, did not provide a cost-benefit analysis of the proposed solution, and did not adopt a solution narrowly tailored to address the problem. When the NPRM was published, ATF simultaneously provided a standalone preliminary RIA that discusses, in detail, the costs and benefits of the rule.<sup>156</sup> The rule is

<sup>156</sup> The RIA is available on *Regulations.gov* at <https://www.regulations.gov/docket/ATF-2021-0002/document> and on ATF’s website at <https://>

narrowly tailored because ATF has selected for consideration under the final rule—after the benefit of extensive public comment—only those factors (including objective design features, marketing materials, and information from the general community) that indicate a weapon with an attached “stabilizing brace” is designed, made, and intended to be fired from the shoulder. Based on the careful attention given to selecting the appropriate factors, ATF does not believe the rule will sweep in weapons that are not in fact “rifles” as that term is defined in the NFA.

#### b. Population

##### Comments Received

Several commenters were confused by the difference in population numbers—the 3 million estimated “arm braces” versus the 1.4 million individuals affected. They stated that ATF’s cited population of 1.4 million individuals in possession of “braces” was too low. Another commenter suggested the cost estimate was incorrect because the population of firearms impacted by the proposed rule was too low. Many commenters pointed out a discrepancy regarding the number of pistol-braced firearms projected to be impacted by the proposed rule. These commenters additionally stated that the proposed rule used an estimated circulation of 3 to 7 million pistol braces, while a recently published Congressional Research Services (“CRS”) report had an estimate suggesting there may be between 10 and 40 million braces with some arguing that the number of braces and pistol-braced firearms would be “upwards of 40,000,000.” Another commenter suggested ATF’s intentional use of the lower estimate of 3 million was “self-serving.” One commenter implied that, if ATF were to use the 3 to 7 million range, then the midpoint (5 million) should be the number used. One commenter believed that ATF likely underestimated the number of FFLs engaged in the buying and selling of “brace” devices, thereby suggesting that the impact to the industry would be greater than what was stated in the proposed rule. Finally, a commenter stated that ATF’s analysis assumed that “every stabilizing brace in existence is covered by the NPRM” (emphasis omitted), and the commenter thus worried the rule will ban all existing “stabilizing braces.”

[www.atf.gov/rules-and-regulations/factoring-criteria-firearms-attached-stabilizing-braces](http://www.atf.gov/rules-and-regulations/factoring-criteria-firearms-attached-stabilizing-braces).

#### Department Response

The Department disagrees with the commenters regarding the estimated population of individuals affected by this rule and the number of “brace” devices and firearms with an attached “stabilizing brace” currently in circulation. ATF estimates that there are 3 million “stabilizing braces” and firearms with an attached “stabilizing brace” currently in circulation. While ATF estimated in the NPRM that the number of “brace” devices is between 3 million to 7 million, ATF anticipates that the more accurate figure is closer to 3 million. This estimate is based on anecdotal commentary from the manufacturers, information gleaned from ATF field offices throughout the United States, and subject matter experts’ conclusion that—based on the number of pistols manufactured during the same time period and the popularity of the “brace” devices over the years—manufacturers may have inflated their sales estimates in recent years. In particular, “stabilizing braces” have only been on the market since 2012 and became more popular only in the last few years, so there has not been enough time for as many of them to be sold as reported in some estimates.

The Department disagrees that there is a 1:1 ratio between the number of individuals affected and the number of “stabilizing braces” or firearms equipped with a “stabilizing brace” in circulation. The Pew Research Center reports that, of people who own firearms, two-thirds own multiple firearms; and, as evidenced by the number of bump-stock-type devices turned in by each individual after a previous ATF rulemaking, individuals can and are likely to purchase more than one firearm or, in this case, more than one “stabilizing brace” or firearm with an attached “stabilizing brace.”<sup>157</sup> After publication of the Bump-Stock-Type Devices final rule in December 2018,<sup>158</sup> individual owners turned in between 1 and 63 bump-stock-type devices. Overall, ATF found that people turned in to ATF an average of 2 bump stocks. Therefore, the number of individuals affected by this rule is likely lower than the number of “stabilizing braces” or firearms equipped with a “stabilizing brace” currently in circulation.

It should be noted that the original maker of the “stabilizing brace” marketed it in 2012 and 2013 to assist

<sup>157</sup> The Demographics of Gun Ownership, Pew Research Center (June 22, 2017), <https://www.pewresearch.org/social-trends/2017/06/22/the-demographics-of-gun-ownership/>.

<sup>158</sup> 83 FR at 66514.

persons with disabilities or limited mobility to shoot a heavy pistol with a single hand. The demand and production for “stabilizing braces” did not appear to take off until 2017, when numerous other models were produced that were marketed to shoulder fire a firearm and several manufacturers sold firearms equipped with a purported “stabilizing brace.” This relatively recent rise in popularity suggests that “brace” devices and firearms equipped with a “stabilizing brace” have not been around long enough to warrant larger figures, as discussed further in this section below.

ATF is aware that the CRS report provided higher numbers of “stabilizing braces,” but it also provided no basis for its unofficial estimate.<sup>159</sup> To determine whether this estimate was suitable for purposes of ATF’s RIA, ATF compared CRS’s figures against those provided in the report on *Firearms Commerce in the United States: Annual Statistical Update 2021*.<sup>160</sup> This report provides an estimate of the number of firearms (including pistols, revolvers, rifles, shotguns, and miscellaneous firearms) manufactured in the United States, as reported by manufacturers. According to the report, ATF estimates that a total of 65.1 million firearms, with just under 27 million pistols, were manufactured in the United States between 2013 and 2019.<sup>161</sup> Although the most recent report is not yet final, ATF’s estimates that 12 million firearms were manufactured in 2020.<sup>162</sup> Therefore, ATF now estimates that, between 2013 to 2020, a total of 77.1 million firearms, of which 32.4 million pistols, were manufactured in the United States.

If there was a population of 10 to 40 million “stabilizing braces,” as suggested by CRS, this range would be too high. Using the high end of the range would mean there are at least as many “brace” devices or firearms with an attached “brace” device as there were pistols manufactured in the U.S. between 2013 to 2020 (*i.e.*, 32.4 million pistols). And even at the low end of the CRS estimate, it would mean nearly a third of the pistols manufactured between 2013 to 2020 are equipped with a “stabilizing brace.” Because “stabilizing braces” are only used on a subset of pistols, not on all pistols, and

<sup>159</sup> William J. Krouse, Congressional Research Service, *Handguns, Stabilizing Braces, and Related Components 2* (updated Apr. 19, 2021), <https://crsreports.congress.gov/product/pdf/IF/IF11763>.

<sup>160</sup> ATF, *Firearms Commerce in the United States: Annual Statistical Update 2021*, <https://www.atf.gov/firearms/docs/report/2021-firearms-commerce-report/download>.

<sup>161</sup> See *id.* at 2.

<sup>162</sup> This estimate comes from ATF’s OSII.



because not all pistols manufactured are pistols equipped with a “stabilizing brace” or are the type of pistol for which a person would attach a “stabilizing brace,” ATF’s subject matter experts concluded that using the CRS estimate was not appropriate for this analysis. Further, anecdotal commentary from industry that ATF received as it was preparing the preliminary RIA for the NPRM also suggested to ATF that the CRS estimate is much too high. Therefore, ATF does not adopt the CRS figures.

ATF is also choosing not to use the mid-point estimate of 5 million as suggested by Sig Sauer. Based on the historical number of pistols produced, an estimate of 5 million would suggest that there was just under one firearm with an attached “stabilizing brace” produced for every six pistols manufactured (or approximately 16 percent of all pistols). Additionally, based on information gleaned from field offices throughout ATF, only a subset of FFLs may carry “braces” or firearms with an attached “brace,” and of those that do carry these items, they carry in their inventory only an average of seven “braces” or firearms with a “brace” device.<sup>163</sup> ATF’s survey, as described in footnote 163, suggests that a ratio of one firearm with a “stabilizing brace” produced for every six pistols would still be too high. ATF thus concluded that, based on its experience, an estimate of 5 million was too high. ATF also considers that choosing to use 3 million rather than 5 million is reasonable because “stabilizing braces” did not become more popular until recent years, and hence manufacturers likely did not have sufficient time to produce numbers in the range of the higher estimates suggested by commenters or CRS and as discussed in the paragraphs above.

ATF agrees that it may have not accounted for all “stabilizing braces” being used by persons with disabilities; however, ATF disagrees that this oversight indicates that the rule

<sup>163</sup> Based on an informal survey of ATF’s 25 field divisions, 11 of the field divisions provided an estimated number of FFLs dealing in firearms with an attached “stabilizing brace,” along with an estimated number of affected firearms per FFL. Based on the responses, ATF estimated that approximately 10,420 FFLs from the 11 field divisions deal in firearms with attached “brace” devices and, of these FFLs, they may have carried between 1 to 52 firearms with an attached “stabilizing brace,” with the majority of FFLs having under 20 such firearms in their inventory. Therefore, for the purposes of the final RIA, ATF used the NPRM estimate of 25 percent of FFLs dealing in firearms with an attached “stabilizing brace” and used the survey average of 7 firearms for inventory, which is higher than the 3 used in the NPRM.

prohibits any “stabilizing braces,” including those used by persons with disabilities. For purposes of the final RIA analysis, ATF incorporates this public comment and estimates that a portion of the existing “stabilizing braces,” including some that may have been purchased by persons with disabilities, will not, when attached to a firearm, result in a weapon designed and intended to be fired from the shoulder. That portion of existing “braces” will not be affected by the rule.

Under the statutory provisions, companies may still produce “stabilizing braces,” and individuals may continue to possess and use them to assist with one-handed shooting. In publishing the NPRM and this rule, ATF made every effort to make clear that neither the rule nor the statutes prevent persons with disabilities from possessing a “stabilizing brace” that aids in stabilizing the arm to shoot a pistol with one hand. The rule only articulates—based on the best interpretation of the relevant statutes—how to determine which of those firearms configured with a “stabilizing brace” fall within the definition of “rifle.” Rifles with barrel lengths of less than 16 inches are short-barreled rifles subject to NFA registration and taxation requirements, but they are not illegal to possess so long as those requirements are followed.

#### c. RIA Scenarios 1 and 2: Turn in Firearm to ATF or Destroy Whole Firearm

##### Comments Received

Several commenters suggested that the number of bump-stock-type devices that were turned into ATF after issuance of the bump-stock regulation demonstrates the expected level of compliance for this final rule regarding “braces.” These commenters contended that, because the number of bump stocks turned in to ATF was low, a regulation is an ineffective means of removing devices from the market. One commenter echoed the ATF’s subject matter experts’ opinion that this scenario (*i.e.*, turning in or destroying the firearm) was the least likely to occur upon promulgation of the final rule. Several commenters suggested that the cost associated with turning in a firearm with an attached “stabilizing brace” will be \$200 for the brace itself and \$1,000 to \$2,500 for the firearm. The commenter also suggested that a small percentage of the population (five percent) may opt to turn in the whole firearm or destroy the firearm.

#### Department Response

The Department disagrees that the number of bump-stock-type devices that were turned in to ATF demonstrates the level of compliance expected for a given rule. Under the Bump-Stock-Type Devices rule, a person could comply in ways other than turning in bump stock-type devices to ATF. ATF did not anticipate that many people would turn in bump stock-type devices to ATF, and, in fact, many did not.

Neither the relevant statutes nor this rule suggests that “stabilizing brace” devices themselves are considered a firearm. And, therefore, they do not need to be turned in to ATF. One means of complying with the relevant statutory requirements is to turn in the whole firearm that is equipped with a “stabilizing brace.” Although ATF finds this to be an unlikely scenario, ATF concurred with the commenter that ATF should account for a small percentage of persons who opt to turn in or destroy the whole firearm because some “stabilizing braces” may be attached to a firearm in such a way that removal may not be feasible. However, ATF did not incorporate the percentage as suggested by the commenter because the percentages were based on the assumption that ATF would charge a \$200 NFA tax on all items currently in circulation. Because ATF will forgo the NFA tax on all individuals and most FFLs<sup>164</sup> in possession of short-barreled rifles equipped with a “stabilizing brace” so long as they submit an E-Form 1 within 120 days from this rule’s publication date, ATF estimated percentages for these scenarios by using: (1) the percentage from the bump-stock turn in, and (2) the percentage of individuals or FFLs residing or located in States that do not allow for personal ownership of NFA weapons. For more details on the percentage attributed to destroying or turning in firearms to ATF, please refer to the standalone final RIA on the docket.

#### d. RIA Scenario 3: Convert Firearm Into Long-Barreled Rifle

##### Comments Received

Multiple commenters proffered various cost estimates for Scenario 3 regarding converting a firearm into a long-barreled rifle. A commenter stated that the proposed rule failed to consider

<sup>164</sup> Type 7 FFL SOTs in possession of short-barreled rifles equipped with a “stabilizing brace” at the time this rule is published may register the firearms in their possession through an E-Form 2 (rather than an E-Form 1). Because registration via the E-Form 2 does not require the separate payment of a making tax, there is no tax for ATF to “forbear” from collecting for these weapons.

any labor or expense involved in rebuilding or retrofitting firearms with longer barrels or obtaining necessary parts to do so, specifically in reference to those individuals without gunsmithing knowledge. Another commenter similarly stated the analysis of converting a firearm into a long-barreled rifle was incorrect because it did not account for gunsmithing costs and because installing a longer barrel onto an AR-patterned firearm requires special tools. The commenter elaborated that not all pistols with a “stabilizing brace” are AR patterns, and, for those, additional parts and gunsmithing costs may be involved. One commenter contended that the cost estimates in the RIA failed to include the labor expense for gunsmith services and suggested an estimate of \$750 per firearm.

One commenter provided an estimated percentage of the population that may fall under this scenario (10 percent) and further suggested that the cost to convert a pistol into a rifle will be \$800. When converting a firearm with an attached “stabilizing brace” to a long-barreled rifle under the GCA, one commenter stated, ATF only considered the cost of a new barrel and handguard; that commenter suggested that ATF also should include the cost to re-barrel the firearm, which they estimated to cost anywhere from \$50 to \$250. This commenter also suggested that ATF consider the lost value of the existing barrel and handguard. By including all these cost elements, this same commenter suggested that the actual cost to convert a firearm into a long-barreled rifle is more in the range of \$870 to \$1070. One commenter estimated that it would cost about \$600 to convert a firearm into a long rifle. Another commenter estimated the cost to re-barrel a firearm to be in the range of \$55 to \$350 (plus shipping cost to a gunsmith at \$25 each way). Lastly, a commenter suggested that some barrels and handguards could cost as much as \$1,000 to replace.

One commenter reflected on the likelihood of the various compliance scenarios and suggested that converting a firearm with an attached “stabilizing brace” to a rifle may be more likely to occur if the overall cost is cheaper than the NFA tax. This commenter also stated that the conversion cost provided by ATF was too low. On a separate note, one commenter stated that, while ATF complied with all the necessary economic requirements and determinations, the cost evaluation and impacts of the proposal were a secondary consideration behind ATF’s apparent policy aims.

#### Department Response

With respect to comments asserting that the costs evaluation and impacts of the rule were secondary, the Department disagrees that the regulatory analysis did not account for the cost to individuals to remove firearms from the purview of the NFA. The Department considered the cost to purchase a new barrel and handrails based on the market prices of the items. While the cost analysis did not consider the labor and expense to alter firearms, this is not an indication that the cost evaluation or impacts of the proposal was a secondary consideration.

The Department agrees that a labor cost to convert the firearm into a long-barreled rifle was not included separately; however, ATF included this cost under the market prices for gunsmithing services, which were incorporated in the final RIA as suggested by public commenters for labor costs associated with converting the firearm into a long-barreled rifle. While the Department concurs that there may be a range in costs for the barrel and handguards, the Department kept the prices the same in the final RIA, as the overall cost is between the range of the low and high costs as suggested by the commenters.

#### e. RIA Scenario 4: Apply To Register Under NFA

##### Comments Received

Many commenters claimed that the rule would be a huge financial stress on Americans, and that many of those impacted by the financial burden would have difficulty individually affording the payment of a \$200 tax to keep possession of a firearm that was already possessed and fully legal at the time of purchase. One commenter estimated that 10 percent of the population may fall under this scenario, as they stated that the demand for short-barreled rifles is smaller than for firearms with an attached “stabilizing brace.” Furthermore, this commenter suggested that the administrative cost would be \$75 in addition to the \$200 registration cost.

Some commenters suggested that there are additional costs, beyond the \$200 NFA tax, that must be included when establishing the cost to register a firearm with an attached stabilizing brace as an NFA weapon. At least one commenter in the industry also argued that, even if ATF waived the NFA tax due upon registration, the owner would still have costs for the time and effort required to register. One commenter suggested that there are financial implications, which ATF did not take

into consideration, for owners who will need to modify their firearm to be compliant with 18 U.S.C. 922(r) prior to the NFA registration. Several commenters suggested that ATF did not include the cost to mark the registered firearms. One commenter suggested that it would cost an additional \$30 to \$50 to disassemble and re-assemble a firearm in order to mark the firearm. One commenter contended that ATF did not include the cost of getting fingerprinted or the travel costs to engrave the firearm or obtain fingerprints; the individual suggested that the minimum cost to register a firearm under the NFA would be approximately \$326 per firearm. One commenter stated that considering the NFA tax a transfer payment, and not a societal cost, was “specious.”

Another commenter provided a counter estimate that this scenario would provide a payment to ATF of over \$600 million, “nearly 50% of ATF annual operating budget.” Likewise, a commenter stated that, if ATF’s estimated figure of 3 million pistol-braced firearms is accurate, then the expected financial burden on the taxpayers amounts to \$600,000,000 at a minimum for each firearm with an attached “stabilizing brace” to be registered. One commenter suggested that this scenario would be as likely as Scenario 3 (Convert a firearm with attached “stabilizing brace” into a long-barreled rifle). Another commenter noted that, for those individuals who decide to submit an application to register a short-barreled rifle under the NFA, the NPRM estimated that the proposed rule would add a burden of an additional 3,020,148 hours in addition to the “existing annual hourly burden [which] is 102,808 hours.” 86 FR at 30849. The commenter also stated that “a standard work year is 2,000 hours, meaning that ATF seeks to impose a paperwork burden on the American public equivalent to approximately 1,500 years of productivity or the entire working lives of 38 persons. This would be an unwarranted and unjustified infringement of time and effort for citizens to exercise a fundamental right.” (Emphases omitted.)

#### Department Response

The Department disagrees that all the firearms at issue in this rulemaking were legal at the time of purchase and lawfully possessed. ATF became aware that many short-barreled rifles equipped with a “stabilizing brace” had been sold by various manufacturers as pistols without the submission or receipt of a voluntary classification request from ATF or potentially relying on other

classification letters for other firearms equipped with “stabilizing braces.” Further, ATF notes that many of these “brace” devices alone may have been marketed and sold as a way to add an attachment so that the individual could create a firearm with the “stabilizing brace” that is designed and intended to fire from the shoulder. As short-barreled rifles, these firearms equipped with a “stabilizing brace” must be registered, they must receive transfer or making approval, and they incur a \$200 transfer or making tax, which is imposed on the transferor or maker, respectively. 26 U.S.C. 5811, 5821. These unregistered short-barreled rifles have been transferred in violation of the NFA, and further possession of any such unregistered firearm continues to be a violation of the NFA.

Although the Department disagrees that these unregistered firearms were legal at the time of purchase and lawfully possessed, the Department understands that consumers and dealers believed them not to be subject to the NFA when purchasing and selling them. In the NPRM, the Department had proposed that individuals and most non-SOT FFLs (e.g., Type 1 dealers and Type 7 manufacturers) register and pay the \$200 making tax. However, the Department concurs with many of the public comments regarding forbearance of the \$200 NFA making tax for firearms equipped with a “stabilizing brace” that are short-barreled rifles currently in their possession. Therefore, the Department is not collecting the NFA making taxes for weapons that are affected by this rule and currently in the possession of individuals, Type 1 FFL dealers, Type 7 FFL manufacturers without an SOT,<sup>165</sup> and Type 8 FFL importers provided they submit an E-Form 1 application to register the firearm by May 31, 2023. Likewise, Type 7 FFL manufacturers with an SOT will need to file an E-Form 2 for the firearms with an attached “stabilizing brace” that fall under the purview of the NFA that are currently in their possession by May 31, 2023 in order to comply with Federal law. Type 7 FFLs that do not currently have a Class 2 Manufacturer SOT but that have been engaged in the business and choose to continue to be engaged in the business of manufacturing firearms with an attached “stabilizing brace” that fall under the purview of the NFA will need to obtain an SOT and also file an E-

<sup>165</sup> A Type 7 FFL manufacturer without an SOT that will not engage in the business of manufacturing firearms with an attached “stabilizing brace” that fall under the purview of the NFA after the publication of this rule may file an E-Form 1 application.

Form 2 to register the firearms in their inventory that are subject to NFA regulations by May 31, 2023.

Because many commenters requested a “tax waiver” as their preferred method (second to grandfathering), and because the Department is no longer requiring that the \$200 NFA making tax be paid upon registration during the 120-day window for compliance, the Department estimates that a significantly higher number of individuals than originally anticipated will opt to register their short-barreled rifle equipped with a “stabilizing brace.” Due to the decision to forgo tax, as discussed above, the Department assumes a different percentage of the population will comply with this scenario (and other scenarios), as suggested by one commenter. Therefore, the Department disagrees with commenters that suggested all individuals will register under the NFA. There may be individuals who still opt for the other scenarios such as disposal or converting their firearm into a long-barreled rifle. For instance, there may be individuals who live in States that do not allow for the ownership of NFA weapons; therefore, the Department still accounts for other individuals choosing from the remaining scenarios.

The Department concurs that there are other costs associated with completing a Form 1 under the NFA, and, accordingly, it incorporated most of these costs under Scenario 4 (Apply to Register Under the NFA). However, ATF is not accounting for the cost to engrave NFA markings on the firearm, nor is ATF considering the cost to disassemble and re-assemble a firearm in order to mark the firearm. For purposes of NFA registration, affected firearms that include the markings required by the GCA can be registered with the original marking if the firearm has already been marked in accordance with 27 CFR 478.92 and 479.102. If the affected firearm is a “[p]rivately made firearm” (“PMF”) as defined in 27 CFR 478.11 and 479.11 without GCA markings, the applicant will be required to mark the firearm in accordance with section 479.102 for NFA registration.<sup>166</sup> “Stabilizing brace” devices, however, were originally designed for heavy pistols, and indeed most “stabilizing braces” are attached to heavy pistols that are variants of rifles. ATF thus estimates that this rule will affect very few PMFs, so ATF did not include the cost to mark any PMFs in its analysis. Nevertheless, the cost to retroactively serialize a PMF to comply with NFA marking requirements is approximately

<sup>166</sup> See 87 FR at 24664–66.

\$30 to \$65 per PMF.<sup>167</sup> Given the small number of PMFs affected by this rule and given the small cost to mark any PMFs that are affected by this rule, ATF does not believe that including any estimate for this cost would significantly affect its final RIA.

While the Department agrees with the commenter that registering firearms with attached “stabilizing braces” under the NFA will impose a time burden, the Department disagrees that it is an unwarranted and unjustified burden. This rule does not change the process to register an NFA firearm or the typical time required to complete each registration. Although more individuals will need to complete the process, the Department has concluded that the public safety benefits of this rule justify the burden on these individuals.

The Department disagrees with the assertion that the treatment of the NFA tax as a transfer payment, as opposed to a societal cost, is “specious.” According to the Office of Management and Budget (“OMB”) Circular A–4, “transfer payments” are payments that are distributed from one group to another group within the U.S. and do “not affect total resources available to society.”<sup>168</sup> In this case, transfer payments are distributed from the general public to the U.S. Government. These distributed resources essentially continue to circulate among the total resources available to the U.S. society.

The Department disagrees that this rule will amount to \$600 million in payments to ATF because the Department is providing tax forbearance; therefore, the commenter’s concern about payments to the government is moot. The Department will not seek retroactive collection of taxes from individuals or FFLs for the NFA making and/or transfer taxes owed as a result of not having timely submitted a Form 1 or Form 2;<sup>169</sup>

<sup>167</sup> Tar Heel State Firearms, SBR/SBS Laser Engraving, [https://tarheelstatefirearms.com/store/index.php?route=product/product&product\\_id=232](https://tarheelstatefirearms.com/store/index.php?route=product/product&product_id=232) (last visited Dec. 12, 2022); Capitol Armory, NFA Laser Engraving, <https://www.capitolarmory.com/sbr-sbs-nfa-firearm-laser-engraving-form1.html> (last visited Dec. 12, 2022); Accubeam, NFA Trust & Manufacturing Engraving, <https://www.accubeam.com/services/nfa-trust-gun-engraving/> (last visited Dec. 12, 2022); Veritas Machining LLC, SBS and SBR Laser Engraving, <https://www.veritasmachiningllc.com/nfaweapons> (last visited Dec. 12, 2022).

<sup>168</sup> OMB, Circular A–4 38 (Sept. 17, 2003), [https://www.whitehouse.gov/wp-content/uploads/legacy\\_drupal\\_files/omb/circulars/A4/a-4.pdf](https://www.whitehouse.gov/wp-content/uploads/legacy_drupal_files/omb/circulars/A4/a-4.pdf).

<sup>169</sup> Type 7 FFL SOTs may manufacture NFA firearms without payment of the making tax pursuant to 27 CFR 479.68 provided that the firearm is reported and registered as required by Part 479. Section 479.103 generally requires a Type 7 FFL SOT to register firearms manufactured on an



however, even if the Department were to collect taxes retroactively, any payment of money for NFA taxes is directly deposited in the General Fund of the United States Treasury Department and is not retained by the Department or ATF. Congress appropriates ATF's budget annually.

The Department disagrees with the commenter who suggested that there will be financial implications resulting from the removal and replacement of imported parts for owners who imported pistols and added a "stabilizing brace." The commenter incorrectly interpreted 18 U.S.C. 922(r) as requiring the removal and replacement of imported parts to comply with section 922(r). Section 922(r) generally makes it unlawful "for any person to assemble from imported parts any semiautomatic rifle," and 27 CFR 478.39 provides that a person may not assemble a semiautomatic rifle using more than 10 of the imported parts listed in the relevant paragraphs of the regulation. The criminal violation under 18 U.S.C. 922(r) is for the "assembl[y]" of the semi-automatic rifle; therefore, modification of this kind of firearm through the removal of the relevant parts would not cure the 922(r) violation because the "assembl[y]" has already occurred. Nevertheless, for the purposes of the costs outlined in the standalone RIA, ATF assumes this group may use another scenario, such as destroying the firearm or turning it in to ATF, by using the population derived from bump-stock-type devices as a proxy.

#### f. RIA Scenario 5: Cost To Dispose of "Stabilizing Braces"

##### Comments Received

One commenter suggested that simply disposing of the "stabilizing brace" in this scenario would be very likely. However, the commenter suggested that individuals would likely separate the "stabilizing brace" from the firearm without permanently disposing of the "stabilizing brace" altogether, and then reattach the "stabilizing brace" onto a firearm when convenient. This same commenter suggested that a scenario in which individuals destroy the entire firearm would be unlikely. One commenter suggested that 70 percent of the population would fall under this scenario and that the cost for this scenario should be \$250 for the value of the "stabilizing brace" and \$250 in

ATF Form 2 by the close of the next business day after the manufacture. Firearms of the sort discussed in this rule were manufactured and subsequently transferred by Type 7 FFL SOTs without the timely submission of a Form 2 by the close of the next business day after manufacture.

diminished value of the firearm, for a total of \$500 per firearm. One commenter suggested that ATF should estimate loss of future "stabilizing braces" on current trends rather than historical sales, and that the future trend of sales for firearms with attached "stabilizing braces" is higher than ATF estimated. Several commenters suggested that the disposal cost for this scenario ranges between \$200 for only the "stabilizing brace" and \$1000 for the firearm with the attached "stabilizing brace." One commenter suggested that ATF include the cost of replacing the buffer tube with a pistol tube.

##### Department Response

The Department disagrees that there should be an additional diminishment in the value of the firearm due to the loss of the "stabilizing brace" in the amount of \$250 above the \$250 value of the "brace" itself. This would constitute double counting the value of the "stabilizing brace." The Department recognizes that some owners may perceive that removal of the "brace" from the firearm as diminishing their value from owning that firearm. The Department, however, cannot reasonably estimate the diminished valuation to such owners because those perceived valuations are subjective and vary from owner to owner.

Because "braces" themselves are not regulated, the Department has not collected information about them that allows it to precisely calculate their popularity. Nonetheless, as explained above, the Department estimates that between 3 and 7 million "stabilizing brace" devices were manufactured over the course of eight years, and the Department will continue to use historical data as a means to project future trends. There is not enough information to support what "current trends" are for the demand of purported "stabilizing braces." Based on public comments, the Department concurs that there may be some individuals who opt to turn in or destroy the whole firearm; therefore, the Department uses the cost of the whole firearm under those scenarios.

With respect to the cost of replacing the buffer tube with a pistol tube, the rule does not require such a replacement. The Department also finds it unlikely that these individuals will purchase a pistol tube; therefore, the cost for a pistol tube was not included in the final analysis.

##### g. Other Costs

##### Comments Received

Many commenters believed the initial RIA underestimated the costs, specifically the annualized costs of the proposed rule. One commenter suggested that the cost for this rule ranges from \$600 million to \$40 billion, and that "more than 20,000 [special] agents would be needed" to enforce this rule. One commenter suggested that the annualized cost cited in the NPRM does not account for the total cost of the rule over the course of the next 10 years. The commenter went on to contend that this rule would cost well over \$100 million, and that ATF should refrain from finalizing the rule until ATF can publish an accurate cost analysis. One commenter estimated that the total cost of the rule would be closer to \$465 million. Many commenters suggested that ATF's cost analysis was inaccurate, calculating the cost of the rule to be the total number of "stabilizing braces" multiplied by each scenario rather than breaking out the total population among the different scenarios. One commenter suggested that the total cost of the rule is greater than the estimated annualized cost of \$250 million. Many commenters stated the proposed rule would cost the gun industry and firearm owners tens, if not hundreds, of millions of dollars in conversions, taxes, and destruction of personal property.

At least one commenter stated that ATF's RIA skirted the issue of individuals and entities losing money on their "stabilizing brace" investments. According to the commenter, this rulemaking results in those law-abiding Americans forfeiting their investment in "stabilizing braces" and firearms sold with "stabilizing braces" installed at the factory. At a minimum, the commenter stated, the rule results in the loss of \$708 million to law abiding Americans (*i.e.*, \$236 per "stabilizing brace" \* 3 million sold). Another commenter, assuming the CRS's population of "stabilizing braces" is accurate, stated that the NPRM would destroy economic value and waste American productivity and that the proposed rule's estimated economic impact was too low. Similarly, several commenters suggested that this rule will destroy the entire firearms industry and estimated that this rule will directly affect 150,000 employees and indirectly affect 188,000 individuals, having a total economic impact of \$63.4 billion.

One commenter reasoned that, using an estimated number of 5 million stabilizing braces currently in circulation, the estimated cost for this rule was \$2.8 billion and this cost did

not account for increased government costs such as increased classifications, NFA registrations, and enforcement actions that the commenter anticipated ATF would need to incur upon implementation of this final rule. One commenter stated that this rule “attempts to seize[,] waste, and obliterate an unfathomable percentage of the total annual US firearms commerce.” Similarly, a few commenters suggested that government or enforcement costs were not taken into consideration in the cost-benefit analysis, such as the cost of additional “ATF personnel, equipment, facilities, data infrastructure, prosecution, and incarceration fees.” One commenter suggested that this rule will cost \$2.65 trillion to imprison all owners of firearms with attached “stabilizing braces.”

Another commenter suggested that ATF should have to include the cost for lawsuits challenging the rule. One commenter suggested that this rule would affect taxes that are used to restore and conserve land, along with State and local taxes. Another commenter also asserted that the cost estimated for the rule was fundamentally flawed because the alternatives discussed provided for someone who presently owns a firearm with a “stabilizing brace” caused a cost to the private sector.

Other commenters argued that the financial burden would disproportionately impact lower income persons, including Blacks and Hispanics. Additionally, one commenter said that the proposed rule is “classist and racist” because it makes firearm ownership more expensive through additional taxation. This same commenter further stated the rule was “blatantly ableist, and in bad faith based on antiquated assumptions.” And lastly, one commenter suggested that implementing this rule will reduce the ability to hunt feral hogs and claimed that feral hogs cause approximately \$52 million in damages every year.

#### Department Response

The Department partially concurs with the commenters regarding the overall costs that may be incurred following the rule but disagrees with other aspects of the comments. Many of the commenters conflated the annualized cost of the rule with the 10-year undiscounted cost of the rule. In the NPRM, the Department estimated that the 10-year undiscounted cost would be \$1.1 billion, which is higher than the majority of the estimates suggested by the commenters, but not as high as \$40 billion as suggested by one

commenter. While one commenter requested that precise numbers be presented prior to the publication of the rule, the Department is unable to provide numbers to the level of precision requested by the commenter. The Department now provides revised estimates for the final RIA based on information provided by public comments; however, as the Department consistently states, these are estimates and these numbers cannot be determined with as much precision as some commenters would like.

The Department partially disagrees with the estimate that “more than 20,000 [special] agents would be needed.” ATF does not anticipate needing to add or otherwise require additional law enforcement personnel or taking criminal enforcement actions against persons who currently possess previously made weapons with attached “stabilizing braces” during the 120-day period to come into compliance with Federal law. Nonetheless, ATF concurs that there may be additional costs to implement Federal law as clarified by this rule because ATF anticipates adding staff to assist with the processing of NFA applications. Thus, ATF added those additional administrative costs into its analysis, but no additional cost was associated with law enforcement personnel.

As for classifications, “stabilizing brace” companies have submitted their items for classifications prior to this rule for new designs, and companies will remain free to do so after the implementation of this rule. This rule will not change the classification process, so the costs of this process will remain the same. ATF provides several solutions for owners of “braces” to come into compliance.

The Department disagrees that this rule will “destroy the entire firearm industry,” along with the commenters’ estimated 150,000 employees directly affected and 188,000 indirectly affected individuals, or that the rule will have a total economic impact of \$63.4 billion. The majority of the firearms industry does not engage in manufacturing, selling, or purchasing “stabilizing braces” or firearms with an attached “stabilizing brace.” Furthermore, the firearms with attached “stabilizing braces” do not constitute the entire firearms industry. Most firearms have been sold and are sold without “braces” or are purchased without the intent to attach a “brace.” Firearms that will be affected by this rule are only a small subset of the whole firearms industry. While this rule will have an effect on the firearms industry, it will not adversely impact the industry as a

whole; therefore, the estimated impact on the entire firearm industry was not considered as part of the final analysis.

Most firearms currently on the market are and will remain outside the purview of the NFA; they should not be affected by this rule. The rule may, however, affect a small subset of manufacturers and retailers, and ATF has accordingly updated the Initial Regulatory Flexibility Analysis (“IRFA”) to account for these businesses in the Final Regulatory Flexibility Analysis (“FRFA”).

As for lawsuits challenging this rule and taxes to restore and conserve land, along with State and local taxes, ATF does not account for the cost of lawsuits, taxes, and land conservation because doing so would require far too much speculation for any estimates to be useful. In addition, ATF does not account for the tax impact of the rule because, as described above, the firearms industry as a whole will be largely unaffected by this rule. As a result, ATF expects the industry will continue to make the relevant tax contributions for conservation, as well as to State and local governments.

The Department disagrees this rule will disproportionately affect lower income individuals or certain minorities. As discussed in section IV.B.4.f of this preamble, the NFA tax is a rational mechanism to control the making and transfer of dangerous and unusual firearms that are concealable and capable of more damage than other firearms. The rule, which remedies ATF’s past misinterpretation of the relevant statutory definitions, provides every individual—no matter their race, gender, or disability—the opportunity to remedy violations of the NFA and maintain possession of their firearms so long as the person is not prohibited from firearm possession.

ATF concurs that this rule could possibly have an effect on hunting feral hogs, but notes that this rule does not ban the purchase or use of NFA items; rather, the rule only requires that NFA registration and taxation requirements be satisfied for items that fall within the rule’s scope. Under this rule, short-barreled rifles continue to be regulated by the NFA, but so long as an individual complies with the NFA’s requirements, those rifles would remain available for use in feral hog hunting. To the extent that complying with the NFA’s requirements would impose a financial burden on individuals engaged in such hunting, the Department believes the public safety benefits of the rule outweigh that burden.

## h. Benefits

## Comments Received

Many commenters questioned ATF's assertion that this rule will improve public safety and believed that there is no evidence to demonstrate that Americans will be safer if this rule goes into effect. Commenters asserted that criminals are not going to care about this rule and that this rule will do nothing to prevent or mitigate actual criminal activity. Commenters stated that ATF has arbitrarily decided that an AR-pistol is a "gangster type weapon," even though, in the opinion of the commenters, criminals actually prefer handguns to rifles. Another commenter stated that ATF was only speculating that the proposal would reduce criminal use of firearms.

Many commenters claimed that such "braces" are rarely used in the commission of crimes and that the rule will have no benefit to public safety. Specifically, numerous commenters stated that the purpose of the NFA is "to regulate certain weapons likely to be used for criminal purposes." In these commenters' opinion, there is no reason to believe firearms with an attached "stabilizing brace" are likely to be used for criminal purposes. The commenters went on to say that, since ATF approved the first "stabilizing brace" in 2012, there has not been any notable spike in homicide, violent crime, or crime involving stabilizing braces. They argued that there is not a correlation, let alone a causal link, between the presence of "braced" firearms and higher crime rates, and there is no evidence to suggest that regulating "braced" firearms under the NFA will reduce crime rates. Some commenters, like the Ohio Attorney General, acknowledged that the Department noted examples of weapons with "stabilizing braces" being used in at least two mass shootings, but many commenters considered those two instances to be misuses of the "stabilizing brace" in criminal acts. The commenters argued that, considering the millions of "braces" in use, such examples provide insufficient evidence to suggest that regulating "braced" firearms under the NFA will reduce crime rates. Another commenter went as far as to classify the resulting "reduced ability for self[-]defense" to be "the most damaging and life[-]threatening form of discrimination." Another commenter believed that the proposed rule would destroy the value of "braces," which would lead to legal owners selling them in order to recoup their losses, thus making them "more readily available to criminals seeking to

make a short-barreled rifle for malicious purposes."

Commenters questioned the idea that a "stabilizing brace" makes a gun more lethal. According to a commenter, the proposed rule was based on the proposition that adding a "stabilizing brace" to pistols makes them "especially dangerous to the community." Numerous commenters did not believe that ATF had substantiated its claims that "brace"-equipped pistols are especially dangerous or unusual. Commenters questioned how these firearms are more dangerous than "other common pistols." Some commenters suggested that a short-barreled rifle is not more concealable than other firearms. Likewise, a commenter stated, "I don't see how a brace on a regular-sized pistol makes the gun especially dangerous or unusual as it doesn't increase the power or lethality of a 'regular pistol.'" Another commenter argued that it is not a fact that stabilizing braces are more effective when firing the firearm. Or, as many commenters stated, "even if the user shouldered the stock pistol, it [does] not magically turn that pistol into a[n] SBR." Conversely, some commenters contended that it was actually safer or less lethal to use a "stabilizing brace." Collectively, these commenters stated that a "stabilizing brace" does not make the gun "more scary" because the brace allows a person to shoot the gun "more safely for the shooter as well as [the] people around you."

## Department Response

The Department disagrees with commenters that the rule has no value or that there is no benefit to the rule. The perception that the rule serves no function to enhance public safety is directly opposed to the purpose and intent of the NFA. Congress passed that statute for the express purpose of regulating specific firearms, like short-barreled rifles, which Congress determined posed a greater risk to public safety as "gangster-type" weapons of an especially unusual and dangerous nature. This rule makes clear that a firearm cannot evade classification under the NFA if it has objective design features that indicate (or if there are marketing materials or other information demonstrating likely use in the general community that indicate) it is designed, made, and intended to be fired from the shoulder and has a barrel length of less than 16 inches. Therefore, the Department emphasizes that the risk posed to public safety by these weapons was identified by Congress, and this rule acts to

implement the NFA. The rule is necessary to effectuate the laws passed by Congress to address congressional concerns for risks imposed to public safety by firearms as defined under the NFA.

As for reducing the ability for self-defense, the Department disagrees. There are various firearms that are available for self-defense under the GCA and will continue to be available. Furthermore, this rule does not ban the use of firearms with an attached "stabilizing brace." Individuals can and will continue to be able to use such firearms for personal defense. Individuals have various means of complying with the relevant statutory requirements and will not need to sell any firearms that they may possess. See section IV.A.2 of this preamble for additional Departmental response regarding public safety.

## i. IRFA/FRFA

## Comments Received

Some commenters suggested that this rule will "harm millions of jobs" and "shut down dozens of small businesses." Various commenters suggested that this rule will affect the American economy and, in particular, all manufacturers that sell firearms with an attached "stabilizing brace" and FFL dealers that deal in firearms with an attached "stabilizing brace." One commenter suggested that FFL dealers would not be able to convert firearms with attached an "stabilizing brace" without obtaining an SOT and would have to otherwise dispose of their inventory of firearms with attached "stabilizing braces." Another commenter suggested that this would increase the burden on small businesses by adding additional tracking and reporting requirements.

## Department Response

While ATF agrees that the rule will affect a number of small businesses and a small number of jobs, ATF disagrees with the magnitude of impact suggested by some commenters. There are only a few companies that manufacture "stabilizing braces," and for most of them, "braces" or firearms with an attached "stabilizing brace" are not their primary source of revenue. In the IRFA, ATF calculated an estimated impact to FFL Type 1 dealers, as well as an estimated impact on FFL Type 7 manufacturers. For the FRFA, ATF provides a revised impact analysis illustrating with more detail the estimated impacts to Type 1 and Type 7 FFLs, along with manufacturers of "stabilizing braces."



While ATF updated the population in the FRFA, it did not receive sufficient information in the public comments as to the actual impact; therefore, the revised analysis did not include any such additional information.

In the IRFA, ATF estimated the number of businesses that will go out of business. The FRFA provides a more detailed analysis on the anticipated number of businesses that will go out of business, the anticipated loss of revenue, and the anticipated number of jobs affected. However, the overall effect that the rule will have on small businesses is anticipated to be small. While the Department acknowledges that most businesses in the firearms industry are small, most firearms with attached “stabilizing braces” are a subset of the inventory of firearms sold by these businesses. Therefore, this rule’s clarification of Federal law will affect, at most, a small portion of the businesses’ inventories, with the extent of the impact depending on how they choose to comply after publication of this rule. It is unlikely that all businesses that deal in firearms with attached “stabilizing braces” will shut down as suggested by commenters.

As for additional tracking and reporting requirements, ATF has already accounted for the additional paperwork associated with Form 1 and Form 2 applications for NFA items. There may be additional paperwork should Type 7 FFL manufacturers opt to obtain an SOT, but doing so is not required, and, due to ATF’s decision to forbear taxes as discussed in this preamble, it is deemed unlikely that FFLs will apply for an SOT.<sup>170</sup> No additional paperwork was required.

#### j. Other Executive Orders

##### Comments Received

At least one commenter objected to ATF’s determination under Executive Order 13132 (Federalism) that the rule will not have substantial direct effects on the States, the relationship between the Federal Government and the States, or the distribution of power and responsibilities among the various levels of government. This commenter contended that if the rule costs more than \$100 million, the rule should be null and void.

<sup>170</sup> In the absence of the forbearance, some Type 7 FFLs may have found it more economical to pay the costs required to become an SOT holder than to pay the costs to register each of the weapons affected by this rule that they have in their inventory. Because ATF is no longer requiring payment of the making tax for weapons held in Type 7 FFLs’ current inventory, ATF expects that becoming an SOT will no longer be a more economical option.

#### Department Response

The Department concurs with the commenter that this rule will have costs more than \$100 million in any given year but disagrees that the rule implicates Executive Order 13132. This rule will not have a substantial direct effect on the States, the relationship between the Federal Government and the States, or the distribution of power and responsibilities among the various levels of government. Although some State laws incorporate Federal law for purposes of banning or otherwise regulating short-barreled rifles, this rule does not purport to preempt any State laws, nor does it require any State to change its laws.

Should States or political subdivisions of the States (for example, local police departments) possess weapons with “stabilizing braces” that constitute unregistered short-barreled rifles, these firearms must be registered in the NFRTR. ATF estimates, however, that this rule will not affect many States or political subdivisions, so ATF did not include in the FRFA the cost of registering such firearms under the NFRTR by State or local governments. In addition, ATF notes that it may take 30 minutes to complete an Application for Registration of Firearms Acquired by Certain Governmental Entities (“Form 10”), with a loaded wage rate of \$49.67, making the per application burden \$25.<sup>171 172 173</sup> This small cost confirms that the rule will not have a substantial direct effect on States or localities. Finally, there is no dollar threshold under Executive Order 13132, nor is there a threshold that makes a rule “null and void.”

<sup>171</sup> Average wage rate for Police and Sheriff’s Patrol Officers is \$34.02. BLS, Occupational Employment and Wage Statistics, (May 2021), <https://www.bls.gov/oes/2021/may/oes333051.htm>.

<sup>172</sup> ATF uses a loaded wage rate to account for fringe benefits such as insurance. The load rate used for this rule is 1.416. This figure comes from the following calculation: (BLS Series ID CMU201000000000D, CMU201000000000P (Private Industry Compensation = \$37.15))/(BLS Series ID CMU202000000000D, CMU202000000000P (Private Industry Wages and Salaries = \$26.23)) = 1.416. See BLS, BLS Data Finder 1.1, [https://beta.bls.gov/dataQuery/find?fq=survey:\[cm\]&s=popularity:D](https://beta.bls.gov/dataQuery/find?fq=survey:[cm]&s=popularity:D) (last visited Dec. 14, 2022). The exact number may differ slightly because of fluctuations in the compensation and wage and salary rates in the time since ATF performed the calculations.

<sup>173</sup> The Employee Cost Index of 1.031 accounts for wage increases in 2022. BLS, Employment Cost Index March 2022 (Apr. 29, 2022), [https://www.bls.gov/news.release/archives/eci\\_04292022.pdf](https://www.bls.gov/news.release/archives/eci_04292022.pdf).

#### 9. Considerations on Options To Comply

##### a. No Change Alternative

##### Comments Received

Many commenters wanted ATF to allow weapons with “stabilizing braces” to continue to be possessed and sold without compliance with the NFA. Many commenters stated their support for the no-change alternative and possibly grandfathering all existing stabilizing braces. These commenters also expressed a strong aversion to registering the firearms under the NFA, but nonetheless favored the waiver of the \$200 NFA tax, as opposed to banning these items, if such registration was required.

##### Department Response

The Department acknowledges commenters’ suggestion that the \$200 NFA tax for the transfer or making of an NFA firearm be waived if registration is required. For the Department’s response on this, see the discussion in section IV.B.8.e of this preamble. The Department considered but cannot adopt the “no change” alternative because it would result in the status quo—the manufacturing, making, and possession of unregistered NFA firearms. The NFA, clarified in this rule, regulates all firearms equipped with a “stabilizing brace” that are short-barreled rifles because they have a barrel or barrels less than 16 inches in length and have the features listed in this rule indicating they are designed, made, and intended to be fired from the shoulder, or because the manufacturer’s direct or indirect marketing material or use by the general community indicates they are designed, made, and intended to be fired from the shoulder. As mentioned, the NFA’s requirements cannot be avoided merely because a firearm is configured with a device marketed as a “stabilizing brace.” Thus, as short-barreled rifles, the NFA requires these firearms to be registered and the appropriate taxes be paid for the making and transfer of the weapon. The Department did not need to consider classifying or banning “stabilizing braces” alone without an attached pistol because, under the GCA and NFA, ATF regulates “firearms” as defined by those statutes. “Brace” devices alone are not firearms.

##### b. Grandfathering in Firearms With Attached “Stabilizing Braces”

##### Comments Received

Many commenters contended that firearms with attached “stabilizing braces” should be grandfathered in

under the new rule. One commenter declared that it was a violation of law that no grandfather clause was provided whatsoever, while another commenter believed that the lack of any grace period or grandfathering made it clear the rule was not intended to prevent violent crimes and was only intended to harm law abiding Americans. Similarly, one commenter questioned how ATF was able to reject grandfathering millions of existing braces that were lawfully purchased by gun owners who followed ATF guidance. Other commenters also claimed that, without a grandfather provision, many law-abiding citizens may become liable for prosecution. One commenter opined that owners of firearms equipped with stabilizing braces are faced with a choice of evils: (1) permanently removing the stabilizing brace from their firearm; (2) attaching a 16-inch or longer barrel to their firearm; or (3) destroying their firearm. One manufacturer took issue with ATF's "assumption" that grandfathering existing firearms would be impractical because of ATF's concerns that manufacturers could claim that newly produced rifles with an attached "stabilizing brace" were grandfathered in order to evade NFA regulation.

#### Department Response

The Department disagrees that it must provide individuals a grandfather clause for currently possessed firearms equipped with "stabilizing braces" that are short-barreled rifles under the NFA, or that it must compensate firearm possessors for either the firearm or for the "brace" devices. For the Department's response on compensation, refer above to section IV.B.4.c of this preamble.

The NFA requires that a rifle with a barrel or barrels less than 16 inches, *i.e.*, a short-barreled rifle, be registered in the NFRTR. The NFA makes it unlawful for any person "to receive or possess a firearm which is not registered to him in the [NFRTR]." 26 U.S.C. 5861(d). Further, section 5861(c) makes it unlawful for an individual to receive or possess a firearm made in violation of the provisions of the NFA. An individual in possession of a short-barreled rifle (such as a weapon with a "stabilizing brace" that falls within the scope of the NFA) not registered in the NFRTR would be in violation of sections 5861(c) and 5861(d). A grandfather provision that would prospectively excuse currently possessed NFA firearms from registration would allow continued violations of the NFA indefinitely. Accordingly, for possessors to continue

to possess these firearms and to be able to transfer these short-barreled rifles in the future without being in violation of the NFA, it is necessary for possessors to register in the NFRTR those firearms equipped with a "stabilizing brace" that are short-barreled rifles. As discussed above, so long as affected persons register their short-barreled rifles equipped with a "stabilizing brace" by May 31, 2023, the Department will forbear the NFA making tax that would have been owed and, in its enforcement discretion, will allow these persons to temporarily possess their unregistered NFA firearm until they receive a response from ATF on their application. Section V.B of this preamble discusses options under the rule and sections IV.B.9.c and V.C of this preamble discuss the Department's decision to forbear the making tax upon registration.

The Department also cannot have a grandfather clause because providing one would inappropriately exempt individuals from future compliance with provisions of the NFA. The Department can, in its enforcement discretion, permit the registration of firearms possessed at the time of publication of this rule and forbear the NFA tax due upon registration. In addition, the Department has determined that a limited exercise of its discretion to allow individuals to come into compliance with Federal law is appropriate in light of the prior confusion regarding the scope of the NFA and its application to firearms equipped with "brace" devices. However, this decision is not a prospective exemption for individuals from the requirements of the NFA. The Department has determined that a prospective, indefinite exercise of its enforcement discretion (as embodied in a grandfathering provision for current possessors) is not appropriate because current possessors will have time to acquaint themselves with ATF's clarified regulations and take action to comply with the statute.

#### c. Tax Forbearance for Registration of Short-Barreled Rifles With an Attached "Stabilizing Brace"

##### Comments Received

Commenters claimed this proposal would be the largest registration scheme imposed by the executive branch in American history and would force the registration or destruction of millions of privately owned firearms. Commenters similarly suggested forgiveness of the NFA taxes but were not optimistic of such an approach because ATF

previously rejected forgiveness of the NFA tax.

Some commenters thought that, if the tax is forgiven, more people will comply with the rule. One commenter expressed concern that the proposed rule required that individuals pay the \$200 making tax. They argued that the proposed rule was inconsistent with the statute because it equated possession of firearms with the making of the firearms. Furthermore, the commenter claimed the proposed rule failed to provide guidance as to what constitutes the date of manufacture for firearms that already exist and are subject to the NFA. The commenter also claimed that the proposed rule failed to advise on whether individuals must dispossess themselves of their firearms until their Form 1s are approved. Another commenter stated that "[t]o retroactively make these braced pistols illegal without grandfathering them has the same effect as directly levying a tax upon the citizens." Likewise, another commenter expressed concern that ATF has proposed to impose the tax in the present, regardless of when the firearm was made, and regardless of when the firearm was transferred. One commenter took issue with ATF's position to not forgive the tax upon registration for fear that individuals could register all pistols in their possession as short-barrel rifles with the intent of using other stocks or "brace" devices on those firearms.

#### Department Response

The Department disagrees with commenters that asserted the rule would result in the largest registration in the country's history or the destruction of millions of privately owned firearms. While numerous firearms equipped with "stabilizing braces" are short-barreled rifles based on their objective design features, the Department has provided multiple options for affected persons, which include alternatives that do not require registration or destruction of the firearm.

The Department agrees with the commenter who stated that requiring an individual already in possession of a firearm to pay the making tax is inconsistent with Federal law. As described earlier, the NFA imposes a \$200 making tax and \$200 transfer on NFA firearms. *See* 26 U.S.C. 5811, 5821. The making tax is imposed on the person making the firearm. 26 U.S.C. 5821(b). The population of individuals who possess short-barreled rifles equipped with a "stabilizing brace" includes (1) individuals who made the firearms by adding a purported "stabilizing brace" on the firearm, and

(2) individuals who purchased and received a firearm equipped with a purported “stabilizing brace” from an FFL or another individual. These latter persons who purchased or received the short-barreled rifle equipped with a “stabilizing brace” from an FFL or another individual are not “makers” who have incurred a tax liability.

Accordingly, the Department agrees with commenters and will forbear the making tax on those individuals who did not make the firearm. In addition, even for individuals who did “make” the firearm, the Department believes it is appropriate to forbear the making tax because of the clarification in ATF’s analysis of firearms equipped with a “stabilizing brace” device. This forbearance will also help ameliorate the increased administrative burdens on ATF’s NFA Division, which otherwise would be tasked with making determinations of whether an individual is in fact a “maker” who should incur the making tax. Refer to the discussion in sections IV.B.8.e. and V.B. of this preamble on the way affected parties must register their NFA firearms to come into compliance with Federal law and not be subject to the penalties for being in possession of an unregistered short-barreled rifle.

The Department acknowledges that, in the NPRM’s discussion of alternatives, it did not offer to forbear the NFA tax out of concern that individuals and entities could register all pistols in their possession as short-barreled rifles and then attempt to use other stocks on these firearms or with the intent of later obtaining a “stabilizing brace.” 86 FR at 30847. The Department still has concerns that allowing tax-exempt registration could induce individuals to register other firearms with the later intent of creating a short-barreled rifle. Nevertheless, after careful consideration of the comments, the Department has decided to forbear the making tax when individuals and entities register their affected firearms within a defined period of time for the reasons discussed above in section IV.B.8.e of this preamble. The Department also notes that the ATF Form 1 requires individuals to sign under the penalty of perjury that the description of the firearm, including the type of firearm, is true, accurate, and complete, and that the making and possession of the firearm described in the application would not constitute a violation of Title 18 U.S.C., Chapter 44; Title 26, U.S.C., Chapter 53; or any provisions of State or local law. Any false statement knowingly made on the ATF Form 1 regarding registration pursuant to this rule is a violation of 26

U.S.C. 5861(l). A firearm involved in a violation of section 5861(l) may be seized, and the violation subjects the person to possible conviction, which is punishable by a fine up to \$10,000, or imprisonment up to 10 years, or both. See 26 U.S.C. 5871, 5872. Furthermore, a willful false statement to an agency of the Federal government may also be a violation of 18 U.S.C. 1001, which is punishable by a fine or imprisonment up to five years, or both. The options for persons in possession of short-barreled rifles equipped with a “stabilizing brace” device to come into compliance with the NFA are outlined in section V.B of this preamble.

#### d. Other Suggested Alternatives Comments Received

ATF received several suggestions from commenters on what other actions could be taken apart from pursuing this rulemaking. These included suggestions that ATF fund recalls of firearms with “brace” devices or efforts to replace noncompliant “stabilizing braces” with compliant ones. Commenters opined that short-barreled rifles and shotguns should be removed from the purview of the NFA. One commenter suggested requiring prescriptions to demonstrate that an individual in fact needs a “stabilizing brace” attached to their firearm. Another commenter questioned why ATF did not consider classifying “stabilizing braces” without a pistol attached.

#### Department Response

The Department acknowledges commenters’ suggestions that ATF engage in a buyback of firearms with an attached “stabilizing brace” or that the agency require some proof that an individual demonstrate they need a “stabilizing brace” before acquiring the device. The Department has decided not to adopt such suggestions. Buying firearms with attached “stabilizing braces” would be costly and administratively burdensome, and the Department has provided other options for owners of such devices to consider instead. Requiring proof of a disability or other “need” for a “stabilizing brace” would require medical judgments that are beyond the scope of ATF’s expertise. Finally, with respect to the suggestion that short-barreled rifles and shotguns be removed from the scope of the NFA, doing so is not within the Department’s authority and therefore is beyond the scope of this rule.

## V. Final Rule

### A. Definition of “Rifle”

The rule provides an amendment to the definition of “rifle” in §§ 478.11 and 479.11. In issuing this final rule, the Department has revised the proposed regulatory text in the NPRM to account for the comments received. The rule does not adopt the Worksheet 4999 as proposed in the NPRM. The rule does, however, adopt from the NPRM and proposed Worksheet 4999 several of the objective design features that indicate a firearm is designed, made, and intended to be fired from the shoulder and incorporates those features into the definition of “rifle.” The final regulatory text for the definition of “rifle” reflects the best interpretation of the relevant statutory provisions. All previous ATF classifications involving “stabilizing brace” attachments for firearms are superseded as of May 31, 2023. As such, they are no longer valid or authoritative, and cannot be relied upon. However, firearms with such attachments may be submitted to ATF for re-classification.

This final rule’s amended definition of “rifle” clarifies that the term “designed, redesigned, made or remade, and intended to be fired from the shoulder” includes a weapon that is equipped with an accessory, component, or other rearward attachment (e.g., a “stabilizing brace”) that provides surface area that allows the weapon to be fired from the shoulder, provided that other factors, as listed in the rule, indicate that the weapon is designed, made, and intended to be fired from the shoulder. These other factors are:

(i) whether the weapon has a weight or length consistent with the weight or length of similarly designed rifles;

(ii) whether the weapon has a length of pull, measured from the center of the trigger to the center of the shoulder stock or other rearward accessory, component or attachment (including an adjustable or telescoping attachment with the ability to lock into various positions along a buffer tube, receiver extension, or other attachment method) that is consistent with similarly designed rifles;

(iii) whether the weapon is equipped with sights or a scope with eye relief that require the weapon to be fired from the shoulder in order to be used as designed;

(iv) whether the surface area that allows the weapon to be fired from the shoulder is created by a buffer tube, receiver extension, or any other accessory, component, or other rearward attachment that is necessary for the cycle of operations;



(v) the manufacturer's direct and indirect marketing and promotional materials indicating the intended use of the weapon; and

(vi) information demonstrating the likely use of the weapon in the general community.

#### B. Options for Affected Persons

Persons in possession of short-barreled rifles equipped with a "stabilizing brace" device have until May 31, 2023 to come into compliance with the NFA's requirements. The options are as follows:

##### Current Unlicensed Possessors

1. Remove the short barrel and attach a 16-inch or longer rifled barrel to the firearm, thus removing it from the scope of the NFA.

2. Submit through the eForms system an Application to Make and Register a Firearm, ATF Form 1 ("E-Form 1") by May 31, 2023.<sup>174</sup> The possessor may adopt the markings on the firearm for purposes of the E-Form 1 if the firearm is marked in accordance with 27 CFR 478.92 and 479.102. If the firearm does not have the markings under 27 CFR 478.92 and 479.102, then the individual must mark the firearm as required. Proof of submission of the E-Form 1 should be maintained by all possessors.

To transfer an affected firearm to another individual after the date this rule is published, it must be registered in the NFRTR, and the individual must submit and receive approval on an Application for Tax Paid Transfer and Registration of Firearm, ATF Form 4; otherwise, the transfer is a violation of the NFA. *See* 26 U.S.C. 5861(e).

3. Permanently remove and dispose of, or alter, the "stabilizing brace" such that it cannot be reattached, thereby removing the weapon from regulation as a "firearm" under the NFA. The Department recognizes that the removal of a "stabilizing brace" from a firearm that was originally received as a "short-barreled rifle" results in the production of a "weapon made from a rifle," as defined by the NFA. However, the Department in its enforcement discretion will allow persons to reconfigure the firearm to a pistol by May 31, 2023 and will not require the registration of these firearms as a "weapon made from a rifle."

4. Turn the firearm into your local ATF office.

5. Destroy the firearm. ATF will publish information regarding proper destruction on its website, [www.atf.gov](http://www.atf.gov).

<sup>174</sup> ATF strongly advises that affected parties use the eForms system to lessen the administrative burden in registering firearms affected by this rule.

Federal Firearms Licensed Manufacturers or Importers Under GCA and Qualified as an SOT (Class 1 Importer and Class 2 Manufacturer) Under the NFA

1. Remove the short barrel and attach a 16-inch or longer rifled barrel to the firearm thus removing it from the scope of the NFA.

2. For short-barreled rifles equipped with a "stabilizing brace" that are currently in the possession of FFL SOT manufacturers or importers, they may register them by completing and submitting through the eForms system a Notice of Firearms Manufactured or Imported, ATF Form 2 ("E-Form 2") by May 31, 2023.

To transfer an affected firearm to an individual after the date this rule is published, it must be registered in the NFRTR, and the FFL SOT manufacturer or importer must submit and receive approval on an Application for Tax Paid Transfer and Registration of Firearms, ATF Form 4; otherwise, the transfer is a violation of the NFA. *See* 26 U.S.C. 5861(e). Similarly, to transfer an affected firearm to another FFL SOT, it must be registered in the NFRTR, and the FFL SOT must transfer the firearm on an Application for Tax-Exempt Transfer of Firearm and Registration to Special Occupation Taxpayer (National Firearms Act), ATF Form 3.

3. Permanently remove and dispose of, or alter, the "stabilizing brace" such that it cannot be reattached, thereby removing the weapon from regulation as a "firearm" under the NFA. The Department recognizes that the removal of a "stabilizing brace" from a firearm that was originally manufactured as a "short-barreled rifle" results in the production of a "weapon made from a rifle" as defined by the NFA. However, the Department in its enforcement discretion will allow persons to reconfigure the firearm to a pistol by May 31, 2023 and will not require the registration of these firearms as a "weapon made from a rifle."

4. Turn the firearm into your local ATF office.

5. Destroy the firearm. ATF will publish information regarding proper destruction on its website, [www.atf.gov](http://www.atf.gov).

Federal Firearms Licensees Not Having Paid SOT as a Class 1 Importer or Class 2 Manufacturer Under the NFA

1. Remove the short barrel and attach a 16-inch or longer rifled barrel to the firearm thus removing it from the scope of the NFA.

2. For short-barreled rifles equipped with a "stabilizing brace" that are currently in the possession of FFLs that

do not have an SOT (Class 1 Importer or Class 2 Manufacturer), they may submit through the eForms system an Application to Make and Register a Firearm, ATF Form 1 ("E-Form 1") by May 31, 2023. The possessor may adopt the markings on the firearm for purposes of the E-Form 1 if the firearm is marked in accordance with 27 CFR 478.92 and 479.102. If the firearm does not have the markings under 27 CFR 478.92 and 479.102, then the individual must mark the firearm as required. Proof of submission of the E-Form 1 should be maintained by all possessors.

To transfer an affected firearm to an individual after the date this rule is published, it must be registered in the NFRTR, and the non-SOT FFL must submit and receive approval on an Application for Tax Paid Transfer and Registration of Firearm, ATF Form 4; otherwise, the transfer is a violation of the NFA. *See* 26 U.S.C. 5861(e). Furthermore, if the FFL wishes to continue to engage in the business of dealing short-barreled rifles equipped with "stabilizing brace" devices that are NFA firearms, the FFL must become an SOT holder under 26 U.S.C. 5801.

Any FFL without an SOT that is engaged in the business of manufacturing short-barreled rifles equipped with a "stabilizing brace" device should become a Class 2 SOT if they will continue to engage in the business of dealing and manufacturing NFA firearms. Once they obtain their SOT under 26 U.S.C. 5801, they must register their NFA firearms in the NFRTR by completing and submitting the E-Form 2 by May 31, 2023.

3. Permanently remove and dispose of, or alter, the "stabilizing brace" such that it cannot be reattached, thereby removing the weapon from regulation as a "firearm" under the NFA. The Department recognizes that the removal of a "stabilizing brace" from a firearm that was originally manufactured or received as a "short-barreled rifle" results in the production of a "weapon made from a rifle" as defined by the NFA. However, the Department in its enforcement discretion will allow persons to reconfigure the firearm to a pistol by May 31, 2023 and will not require the registration of these firearms as a "weapon made from a rifle."

4. Turn the firearm into your local ATF office.

5. Destroy the firearm. ATF will publish information regarding proper destruction on its website, [www.atf.gov](http://www.atf.gov).

Certain Governmental Entities

1. Remove the short barrel and attach a 16-inch or longer rifled barrel to the

firearm, thus removing it from the scope of the NFA.

2. Submit through the eForms system an Application to Make and Register a Firearm, ATF Form 1 (“E-Form 1”) by May 31, 2023. The government entity may adopt the markings on the firearm for purposes of the E-Form 1 if the firearm is marked in accordance with 27 CFR 478.92 and 479.102. If the firearm does not have the markings under 27 CFR 478.92 and 479.102, then the government entity must mark the firearm as required. Proof of submission of the E-Form 1 should be maintained by all possessors.

To transfer an affected firearm after the date this rule is published, it must be registered in the NFRTR, and the government entity must submit and receive approval on an Application for Tax Exempt Transfer and Registration of Firearm, ATF Form 5; otherwise, the transfer is a violation of the NFA. See 26 U.S.C. 5861(e).

3. Alternatively, a government entity may submit through the eForms system an Application for Registration of Firearms Acquired by Certain Governmental Entities, ATF Form 10 (“E-Form 10”) by May 31, 2023. The government entity may adopt the markings on the firearm for purposes of the E-Form 10 if the firearm is marked in accordance with 27 CFR 478.92 and 479.102. If the firearm does not have the markings under 27 CFR 478.92 and 479.102, then the government entity must mark the firearm as required. Pursuant to 27 CFR 479.104, any subsequent transfer of a firearm registered on an E-Form 10 is restricted to other governmental entities for official use. Proof of submission of the E-Form 10 should be maintained by all possessors. Because of the anticipated number of submissions in response to this rule, a government entity may wish to submit an E-Form 10 because it will be easier for ATF to distinguish from an E-Form 1 and will allow ATF to more quickly respond to law enforcement needs. However, note that, pursuant to 27 CFR 479.104, any subsequent transfer of a firearm registered on an E-Form 10 is restricted to other governmental entities for official use, *i.e.*, the firearm may not be transferred to a non-government entity.

To transfer an affected firearm after the date this rule is published, it must be registered in the NFRTR and the government entity must submit and receive approval on an Application for Tax Exempt Transfer and Registration of Firearms, ATF Form 5; otherwise, the transfer is a violation of the NFA. See 26 U.S.C. 5861(e).

4. Permanently remove and dispose of, or alter, the “stabilizing brace” such that it cannot be reattached, thereby removing the weapon from regulation as a “firearm” under the NFA. The Department recognizes that the removal of a “stabilizing brace” from a firearm that was originally received as a “short-barreled rifle” results in the production of a “weapon made from a rifle” as defined by the NFA. However, the Department in its enforcement discretion will allow persons to reconfigure the firearm to a pistol by May 31, 2023 and will not require the registration of these firearms as a “weapon made from a rifle.”

5. Turn the firearm into your local ATF office.

6. Destroy the firearm. ATF will publish information regarding proper destruction on its website, [www.atf.gov](http://www.atf.gov).

### C. Discussion of Tax Forbearance

The Department is forbearing the following NFA taxes on persons in current possession of firearms equipped with a “stabilizing brace” as described below:

1. Individuals and FFLs that are not Class 1 (Importer) and Class 2 (Manufacturer) SOT holders in possession of firearms equipped with a “stabilizing brace” that are subject to the provisions of the NFA as of the date this rule is published will not be subject to the \$200 making tax so long as they timely submit an E-Form 1 by May 31, 2023.

2. FFLs that are SOT Class 1 (Importer) and Class 2 (Manufacturer) holders in possession of firearms equipped with a “stabilizing brace” that are subject to the provisions of the NFA as of the date this rule is published must timely register their affected firearms on an E-Form 2 by May 31, 2023. Because the E-Form 2, as noted above, does not require an accompanying NFA tax payment, ATF will not collect any taxes for registration of these weapons.

In addition, the Department will forbear from collecting any transfer tax for the transfer of a weapon with a “stabilizing brace” that is an NFA firearm for any transfer that occurred before the effective date of this final rule.

With respect to the Department’s authority to seek taxes retroactively from individuals and FFLs (regardless of SOT status), the Department notes that Congress in 1996 amended 26 U.S.C. 7805(b) to generally prohibit regulations relating to the internal revenue laws from applying retroactively “to any taxable period before” the date on which such regulation is filed with the **Federal Register**; in the case of a final

rule, the date on which any related proposed or temporary rule was filed with the **Federal Register**; and the date on which any notice substantially describing the expected contents of any temporary, proposed, or final rule is made public.

When Congress made this 1996 amendment, however, it stated that “[t]he amendment . . . shall apply with respect to regulations which relate to statutory provisions enacted on or after the date of the enactment of this Act.” Taxpayer Bill of Rights 2, Public Law 104–168, sec. 1101(b), 110 Stat. at 1452, 1469. Because the NFA was enacted in 1934 (*i.e.*, before the 1996 amendment), the pre-1996 version of 26 U.S.C. 7805 applies. That section provides: “[T]he Secretary may prescribe the extent, if any, to which any ruling or regulation, relating to the internal revenue laws, shall be applied without retroactive effect.” 26 U.S.C. 7805(b) (1994). Section 7805(b) did not include other restrictions on retroactive regulations. Thus, the Department has broad discretion regarding the retroactivity of taxes in this rule. However, the Department believes it is appropriate to forbear this retroactive tax liability. Doing so is appropriate because of past public confusion about what sorts of weapons are in fact NFA firearms and because attempting to collect past making or transfer taxes would impose a substantial administrative burden on ATF to determine which individual or entity did in fact make or transfer the NFA firearm in question.

## VI. Statutory and Executive Order Review

### A. Executive Orders 12866 and 13563

Executive Order 12866 (Regulatory Planning and Review) directs agencies to assess the costs and benefits of available regulatory alternatives and, if regulation is necessary, to select regulatory approaches that maximize net benefits (including potential economic benefits, environmental benefits, public health and safety effects, distributive impacts, and equity). Executive Order 13563 (Improving Regulation and Regulatory Review) emphasizes the importance of quantifying both costs and benefits, of reducing costs, of harmonizing rules, and of promoting flexibility.

OMB has reviewed this rule and determined that this rule is a “significant regulatory action” that is economically significant under section 3(f) of Executive Order 12866, because the rule will have an annual effect on the economy of \$100 million or more.

As required by OMB Circular A-4,<sup>175</sup> ATF has prepared an accounting statement showing the classification of expenditures associated with the final rule.

This rule sets forth standards for evaluating “stabilizing braces” in conjunction with how they modify a firearm. This rule clarifies the definition of “rifle” by providing that the term “designed or redesigned, made or remade and intended to be fired from the shoulder” shall include a weapon that is equipped with an accessory, component, or other rearward attachment (e.g., a “stabilizing brace”) that provides surface area that allows shouldering of the weapon, provided that other factors, as listed in the rule, indicate the weapon is designed, made,

and intended to be fired from the shoulder.

Not only will this rule impact how ATF evaluates new firearms with certain attached accessories, it will also affect ATF’s evaluation of existing firearms with attached “stabilizing braces.” Nothing in this rule bans “stabilizing braces” or the use of “stabilizing braces” on pistols; however, firearms with an attached “brace” device may be subject to statutory and regulatory requirements depending on the firearm’s objective design features and other factors, as discussed in this rule. Should individuals and FFLs be in possession of a firearm with an attached “stabilizing brace” such that the firearm constitutes a firearm under the NFA in addition to the GCA, the affected

persons or FFLs will need to choose one of the following options. The options as presented in the final RIA are:

- Scenario 1: Turn in the entire firearm with the attached “stabilizing brace” to ATF;
- Scenario 2: Destroy the whole firearm;
- Scenario 3: Convert the short-barreled rifle into a long-barreled rifle;
- Scenario 4: Apply to register the weapon under the NFA; or
- Scenario 5: Permanently remove and dispose of, or alter, the “stabilizing brace” from the firearm such that it cannot be reattached.

Table 1 provides the OMB Accounting Statement, which illustrates the primary, minimum, and maximum estimated costs and benefits of this rule.

TABLE 1—OMB ACCOUNTING STATEMENT

Category	Primary estimate	Minimum estimate	Maximum estimate	Units			Notes
				Dollar year	Disc (%)	Period covered (years)	
<b>Benefits</b>							
Annualized monetized benefits (\$ Millions/year) .....	N/A N/A	N/A N/A	N/A N/A	2021 2021	7 3	10 10	
Annualized quantified .....	N/A N/A	N/A N/A	N/A N/A	2021 2021	7 3	10 10	
Qualitative .....	—To prevent manufacturers and individuals from circumventing the requirements of the NFA. —To enhance public safety by reducing the criminal use of NFA firearms, which are easily concealable from the public and first responders.						
<b>Costs</b>							
Annualized monetized costs (\$ Millions/year) .....	\$266.9 245.6	\$266.9 245.6	\$581.9 529.8	2021 2021	7 3	10 10	
Annualized quantified .....	N/A N/A	N/A N/A	N/A N/A	2021 2021	7 3	10 10	
Qualitative (unquantified) .....	N/A.						
<b>Transfers</b>							
Federal Annualized Monetized (\$ Millions/year) .....	N/A N/A	N/A N/A	N/A N/A	2021 2021	7 3	10 10	
From/To .....	From: Individuals and FFLs.			To: Federal Government.			
Other Annualized monetized transfers (\$ Million/year) .....	N/A N/A	N/A N/A	N/A N/A	2021 2021	7 3	10 10	
From/To .....	From: N/A.			To: N/A.			
<b>Effects</b>							
State, local, and/or Tribal governments .....	The rule will not impose an intergovernmental mandate or have significant or unique effects on small governments, or have federalism or Tribal implications.						
Small businesses .....	Approximately 4 manufacturers of “stabilizing braces” will be significantly affected by more than 10 percent of their revenue. May affect 13,210 Type 1 FFLs and 3,881 Type 7 FFLs. Type 1 FFLs may experience a range of costs from \$243 to a cost of \$2,919. Most will not incur a significant effect. Type 7 FFLs may also experience a range of costs from \$738 to \$13,344, to an unknown loss of revenue due to the inability to sell “stabilizing braces.”						
Wages .....	N/A.						

<sup>175</sup> OMB, Circular A-4 (Sept. 17, 2003), [https://www.whitehouse.gov/wp-content/uploads/legacy\\_drupal\\_files/omb/circulars/A4/a-4.pdf](https://www.whitehouse.gov/wp-content/uploads/legacy_drupal_files/omb/circulars/A4/a-4.pdf).



TABLE 1—OMB ACCOUNTING STATEMENT—Continued

Category	Primary estimate	Minimum estimate	Maximum estimate	Units			Notes
				Dollar year	Disc (%)	Period covered (years)	
Growth .....	N/A.						

Table 2 summarizes the affects that this rule would have on the industry and public.

TABLE 2—SUMMARY OF AFFECTED POPULATION, COSTS, AND BENEFITS

Category	Affected populations, costs, and benefits
Affected Population .....	<ul style="list-style-type: none"> <li>• 5 Manufacturers of affected “stabilizing braces.”</li> <li>• 3,881 Manufacturers of short-barreled rifles that have a “stabilizing brace” attachment.</li> <li>• 13,210 Dealers of short-barreled rifles that have a “stabilizing brace” attachment.</li> <li>• 1.4 million firearm owners who have pistols with “stabilizing braces” attached and those who intend to purchase them in the future.</li> </ul>
Societal Costs (annualized) .....	<ul style="list-style-type: none"> <li>• \$263.6 million at 7%.</li> <li>• \$242.4 million at 3%.</li> </ul>
Government Costs (Annualized 7 Percent) .....	<ul style="list-style-type: none"> <li>• \$3.3 million.</li> </ul>
Unquantified Benefits .....	<ul style="list-style-type: none"> <li>• To prevent manufacturers and individuals from circumventing the requirements of the NFA.</li> <li>• To enhance public safety by reducing the criminal use of NFA firearms, which are easily concealable from the public and first responders.</li> </ul>

For details regarding the costs and benefits of this rule, please refer to the standalone final RIA on the docket.

**Need for Federal Regulatory Action**

One of the reasons the Department is issuing rule is that individuals and affected entities affix purported “stabilizing braces” to firearms to circumvent the requirements of the NFA, which requires registration and taxes to be paid on the making and transfer of NFA weapons. Congress chose to regulate these items more stringently, finding them to be especially dangerous to the community if not regulated since they are used for violence and criminal activity. See *Gonzalez*, 2011 WL 5288727, at \*5 (“Congress specifically found that ‘short-barreled rifles’ are primarily weapons of war and have no appropriate sporting use or use for personal protection.” (quoting S. Rep. No. 90–1501, at 28)). Therefore, if persons can circumvent the NFA by effectively making unregistered “short-barreled rifles” by attaching an accessory such as a “stabilizing brace,” these dangerous, easily concealed weapons could more easily proliferate and hence pose an increased public safety problem.

**B. Executive Order 13132**

This rule will not have substantial direct effects on the States, the relationship between the Federal Government and the States, or the

distribution of power and responsibilities among the various levels of government. Although some State laws incorporate Federal law for purposes of banning or otherwise regulating short-barreled rifles, this rule does not purport to preempt any State laws, nor does it require any State to change its laws. Therefore, in accordance with section 6 of Executive Order 13132 (Federalism), the Attorney General has determined that this rule does not have sufficient federalism implications to warrant the preparation of a federalism summary impact statement.

**C. Executive Order 12988**

This regulation meets the applicable standards set forth in sections 3(a) and 3(b)(2) of Executive Order 12988 (Civil Justice Reform).

**D. Regulatory Flexibility Act (“RFA”)**

The RFA establishes “as a principle of regulatory issuance that agencies shall endeavor, consistent with the objectives of the rule and of applicable statutes, to fit regulatory and informational requirements to the scale of the businesses, organizations, and governmental jurisdictions subject to regulation. To achieve this principle, agencies are required to solicit and consider flexible regulatory proposals and to explain the rationale for their actions to assure that such proposals are given serious consideration.” Public

Law 96–354, sec. 2(b), 94 Stat. 1164, 1165 (1980).

Under the RFA, the agency is required to consider if this rule will have a significant economic impact on a substantial number of small entities. Agencies must perform a review to determine whether a rule will have such an impact. If the agency determines that it will, the agency must prepare a regulatory flexibility analysis as described in the RFA.

Under the RFA (5 U.S.C. 604(a)), the FRFA must contain:

- A statement of the need for, and objectives of, the rule;
- A statement of the significant issues raised by the public comments in response to the initial regulatory flexibility analysis, a statement of the assessment of the agency of such issues, and a statement of any changes made in the proposed rule as a result of such comments;
- The response of the agency to any comments filed by the Chief Counsel for Advocacy of the Small Business Administration in response to the proposed rule, and a detailed statement of any change made to the proposed rule in the final rule as a result of the comments;
- A description of and an estimate of the number of small entities to which the rule will apply or an explanation of why no such estimate is available;
- A description of the projected reporting, recordkeeping, and other compliance requirements of the rule,

including an estimate of the classes of small entities which will be subject to the requirement and the type of professional skills necessary for preparation of the report or record; and

- A description of the steps the agency has taken to minimize the significant economic impact on small entities consistent with the stated objectives of applicable statutes, including a statement of the factual, policy, and legal reasons for selecting the alternative adopted in the final rule and why each one of the other significant alternatives to the rule considered by the agency that affect the impact on small entities was rejected.

ATF estimates that this final rule will have a significant impact on a substantial number of small businesses. Therefore, ATF has prepared a FRFA. For more details regarding the impacts to small businesses, please refer to the standalone RIA located on the docket.

#### *E. Small Business Regulatory Enforcement Fairness Act of 1996*

This rule is likely to have a significant economic impact on a substantial number of small entities under the Small Business Regulatory Enforcement Fairness Act of 1996 (“SBREFA”), Public Law 104–121, title II, 110 Stat. 847, 857, 5 U.S.C. 601 *et seq.* Accordingly, the Department prepared an IRFA for the proposed rule and prepared a FRFA for the final rule. 5 U.S.C. 603–04. Furthermore, a small business compliance guide will be published as required by SBREFA.

#### *F. Congressional Review Act*

Pursuant to the legislation known as the Congressional Review Act, *see* Public Law 104–121, sec. 251, 110 Stat. 847, 868 (1996), 5 U.S.C. 801 *et seq.*, OMB’s Office of Information and Regulatory Affairs has concluded that this rule satisfies the definition of 5 U.S.C. 804(2). This rule is projected to have an effect of over \$100 million on the economy in at least one year of the final rule.

#### *G. Unfunded Mandates Reform Act of 1995 (“UMRA”)*

This rule will not result in the expenditure by State, local, and Tribal governments, in the aggregate, of \$100 million or more (adjusted for inflation) in any one year, and it will not significantly or uniquely affect small governments. Therefore, no actions were deemed necessary under the provisions of the UMRA, Public Law 104–4, 109 Stat. 48. However, based on the analysis presented in the RIA, the Department concludes that the rule would impose a Federal mandate on the private sector in

excess of \$100 million in expenditures in any one year. The RIA constitutes the written statement containing a qualitative and quantitative assessment of the anticipated costs, benefits, and alternatives required under section 202(a) of the UMRA. *See* 2 U.S.C. 1532.

#### *H. Paperwork Reduction Act of 1995*

This rule will call for collections of information under the Paperwork Reduction Act of 1995, Public Law 104–13, 109 Stat. 163, 44 U.S.C. 3501–20. As defined in 5 CFR 1320.3(c), “collection of information” comprises reporting, recordkeeping, monitoring, posting, labeling, and other similar actions. The estimate of the paperwork burden discussed in the RIA covers the time for reviewing instructions, searching existing sources of data, gathering and maintaining the data needed, and completing and reviewing the collection.

Under the provisions of this rule, there would be a one-time increase in paperwork burdens of NFA applications. This requirement would be added to an existing approved collection covered by OMB control numbers 1140–0011 and 1140–0012. For details regarding this collection of information, please refer to the standalone Executive Orders 12866 and 13563 on the docket.

#### *Disclosure*

Copies of the final rule, proposed rule, and comments received in response to the proposed rule will be available through the Federal eRulemaking portal, [www.regulations.gov](http://www.regulations.gov) (search for RIN 1140–55), and for public inspection by appointment during normal business hours at: ATF Reading Room, Room 1E–063, 99 New York Ave. NE, Washington, DC 20226; telephone: (202) 648–8740

#### **List of Subjects**

##### *27 CFR Part 478*

Administrative practice and procedure, Arms and munitions, Exports, Freight, Imports, Intergovernmental relations, Law enforcement officers, Military personnel, Penalties, Reporting and recordkeeping requirements, Research, Seizures and forfeitures, Transportation.

##### *27 CFR Part 479*

Administrative practice and procedure, Arms and munitions, Excise taxes, Exports, Imports, Military personnel, Penalties, Reporting and recordkeeping requirements, Seizures and forfeitures, and Transportation.

#### *Authority and Issuance*

For the reasons discussed in the preamble, 27 CFR parts 478 and 479 are amended as follows:

#### **PART 478—COMMERCE IN FIREARMS AND AMMUNITION**

■ 1. The authority citation for 27 CFR part 478 continues to read as follows:

**Authority:** 5 U.S.C. 552(a); 18 U.S.C. 847, 921–931; 44 U.S.C. 3504(h).

■ 2. In § 478.11, amend the definition of “rifle” by adding paragraphs (1) and (2) to read as follows:

#### **§ 478.11 Meaning of terms.**

\* \* \* \* \*

*Rifle.* \* \* \*

(1) For purposes of this definition, the term “designed or redesigned, made or remade, and intended to be fired from the shoulder” shall include a weapon that is equipped with an accessory, component, or other rearward attachment (*e.g.*, a “stabilizing brace”) that provides surface area that allows the weapon to be fired from the shoulder, provided other factors, as described in paragraph (2), indicate that the weapon is designed, made, and intended to be fired from the shoulder.

(2) When a weapon provides surface area that allows the weapon to be fired from the shoulder, the following factors shall also be considered in determining whether the weapon is designed, made, and intended to be fired from the shoulder:

(i) Whether the weapon has a weight or length consistent with the weight or length of similarly designed rifles;

(ii) Whether the weapon has a length of pull, measured from the center of the trigger to the center of the shoulder stock or other rearward accessory, component or attachment (including an adjustable or telescoping attachment with the ability to lock into various positions along a buffer tube, receiver extension, or other attachment method), that is consistent with similarly designed rifles;

(iii) Whether the weapon is equipped with sights or a scope with eye relief that require the weapon to be fired from the shoulder in order to be used as designed;

(iv) Whether the surface area that allows the weapon to be fired from the shoulder is created by a buffer tube, receiver extension, or any other accessory, component, or other rearward attachment that is necessary for the cycle of operations;

(v) The manufacturer’s direct and indirect marketing and promotional

materials indicating the intended use of the weapon; and

(vi) Information demonstrating the likely use of the weapon in the general community.

\* \* \* \* \*

**PART 479—MACHINE GUNS, DESTRUCTIVE DEVICES, AND CERTAIN OTHER FIREARMS**

■ 3. The authority citation for 27 CFR part 479 continues to read as follows:

**Authority:** 26 U.S.C. 5812; 26 U.S.C. 5822; 26 U.S.C. 7801; 26 U.S.C. 7805

■ 4. In § 479.11, amend the definition of “rifle” by adding paragraphs (1) and (2) to read as follows:

**§ 479.11 Meaning of terms.**

\* \* \* \* \*

*Rifle.* \* \* \*

(1) For purposes of this definition, the term “designed or redesigned, made or remade, and intended to be fired from the shoulder” shall include a weapon that is equipped with an accessory,

component, or other rearward attachment (*e.g.*, a “stabilizing brace”) that provides surface area that allows the weapon to be fired from the shoulder, provided other factors, as described in paragraph (2), indicate that the weapon is designed, made, and intended to be fired from the shoulder.

(2) When a weapon provides surface area that allows the weapon to be fired from the shoulder, the following factors shall also be considered in determining whether the weapon is designed, made, and intended to be fired from the shoulder:

(i) Whether the weapon has a weight or length consistent with the weight or length of similarly designed rifles;

(ii) Whether the weapon has a length of pull, measured from the center of the trigger to the center of the shoulder stock or other rearward accessory, component or attachment (including an adjustable or telescoping attachment with the ability to lock into various positions along a buffer tube, receiver extension, or other attachment method),

that is consistent with similarly designed rifles;

(iii) Whether the weapon is equipped with sights or a scope with eye relief that require the weapon to be fired from the shoulder in order to be used as designed;

(iv) Whether the surface area that allows the weapon to be fired from the shoulder is created by a buffer tube, receiver extension, or any other accessory, component, or other rearward attachment that is necessary for the cycle of operations;

(v) The manufacturer’s direct and indirect marketing and promotional materials indicating the intended use of the weapon; and

(vi) Information demonstrating the likely use of the weapon in the general community.

\* \* \* \* \*

Dated: January 13, 2023.

**Merrick B. Garland,**

*Attorney General.*

[FR Doc. 2023-01001 Filed 1-30-23; 8:45 am]

**BILLING CODE 4410-FY-P**



UNITED STATES DISTRICT COURT  
DISTRICT OF CONNECTICUT

EDDIE GRANT, JR., JENNIFER HAMILTON;  
MICHAEL STIEFEL; CONNECTICUT  
CITIZENS DEFENSE LEAGUE, INC.; AND  
SECOND AMENDMENT FOUNDATION, INC.,

Plaintiffs,

v.

EDWARD M. LAMONT, JR., in his official capacity;  
JAMES ROVELLA, in his official capacity;  
PATRICK GRIFFIN, in his official capacity;  
MARGARET E. KELLY, in her official capacity;  
DAVID R. APPLGATE, in his official capacity;  
JOSEPH T. CORRADINO, in his official capacity;  
SHARMESE L. WALCOTT, in her official capacity;  
DAVID R. SHANNON, in his official capacity;  
MICHAEL A. GAILOR, in his official capacity;  
CHRISTIAN WATSON, in his official capacity;  
JOHN P. DOYLE, JR., in his official capacity, PAUL  
J. NARDUCCI, in his official capacity; PAUL J.  
FERENCEK, in his official capacity; MATTHEW C.  
GEDANSKY, in his official capacity, MAUREEN  
PLATT, in her official capacity; ANNE F.  
MAHONEY, in her official capacity,

Defendants.

CIV. NO. 3:22-cv-01223-JBA

February 3, 2023

**CERTIFICATION OF  
COUNSEL PURSUANT TO  
FED. R. CIV. P. 65(b)(1)**

Pursuant to Fed. R. Civ. P. 65(b)(1), the undersigned – as counsel for the Plaintiffs – hereby certify that specific facts in various affidavits attached to the Plaintiffs’ Emergency Motion for a Temporary Restraining Order and a Preliminary Injunction show that immediate and irreparable injury will occur to the Plaintiffs if relief is not granted, what notice has been given to the Defendants, and why further notice should not be required.

**I. Specific Facts Showing Immediate and Irreparable Injury, Loss, or Damage.**

To show irreparable harm, the Plaintiffs must show that, absent injunctive relief, they will “suffer an injury that is neither remote nor speculative, but actual and imminent, and one that cannot be remedied if a court waits until the end of trial to resolve the harm.” *Faiveley Transp. Malmö AB v. Wabtec Corp*, 559 F.3d 110, 118 (2d Cir. 2009). “Whether there is an adequate remedy at law, such as an award of money damages, injunctions are unavailable except in extraordinary circumstances.” *Id.* at 118-19. Courts, however, will presume that a movant has established irreparable harm when the movant’s claim involves the alleged deprivation of a constitutional right. *Am. Civil Liberties Union v. Clapper*, 804 F.3d 617, 622 (2d Cir. 2015).

On January 31, 2023, the U.S. Bureau of Alcohol, Tobacco, Firearms, and Explosives (“ATF”) published a final rule in the Federal Register that redesignated certain firearms that had been considered “others” as either rifles or pistols. See **Exhibit A – Affidavit of Holly Sullivan**, ¶¶ 9-10. In an online public information session ATF gave on January 31, 2023, its officials informed the public that it would not be accepting attempts by Connecticut residents to register their “others” as “short-barreled rifles” so they can keep them. *Id.* at ¶¶ 12-13. ATF’s officials explained that a Connecticut citizen’s continued possession of “others” now that they have been reclassified under federal law, likely violates Connecticut’s prohibition on the ownership of “assault weapons.” *Id.* at ¶ 13.

The Plaintiffs have been unable to determine if the federal reclassification of the legal status of “others” as of January 31, 2023 makes the “others” that they own illegal “assault weapons” under Conn. Gen. Stat. § 53-202a – the prohibition challenged as unconstitutional

in this action. *Id.* at ¶ 14; **Exhibit B – Affidavit of Eddie W. Grant, Jr., ¶¶ 15-16; Exhibit C – Affidavit of Jennifer Hamilton, ¶¶ 15-16; Exhibit D - Affidavit of Michael Stiefel, ¶¶ 15-16.** The combination of federal and Connecticut law, however, renders it extremely unclear whether the Plaintiffs have, overnight, become owners of “assault weapons” in violation of Connecticut’s “assault weapons” prohibition without prior notice and in direct contravention to the position taken by the Defendants over the past many years regarding “others.” **Exhibit A, ¶ 15; Exhibit B, ¶ 17; Exhibit C, ¶ 17; Exhibit D, ¶ 17.**

The practical effect of this new legal landscape is that “others” no longer fall within the legal safe harbor that once existed in federal and Connecticut law. The Plaintiffs now face a choice between risking prosecution as felons or the surrender and destruction of firearms that they have a constitutional right to keep and bear.

There is no remedy, save emergency injunctive relief, that can prevent them from having to make such a choice in derogation of their Second Amendment rights. Thus, emergency injunctive relief is appropriate and necessary in this case.

## **II. Efforts Made to Give Notice**

The Defendants appeared by counsel in this action on November 17, 2022. The Court’s electronic filing system immediately notifies every party whose counsel has appeared of a new filing. Parties and the Court routinely treat these notifications from the Court’s filing system as actual service of documents and pleadings. There is no reason that the undersigned know of that renders this filing any different. Thus, they submit to the Court that the Court’s electronic filing system has provided the notice to the Defendants required by Fed. R. Civ. P. 65.



**CONCLUSION**

For the foregoing reasons, the undersigned certify that emergency injunctive relief is appropriate and necessary in this matter.

Dated: 2/3/2023

Respectfully submitted,

    //s// Doug Dubitsky  
Doug Dubitsky, Esq.  
(ct21558)  
LAW OFFICES OF DOUG DUBITSKY  
P.O. Box 70  
North Windham, CT 06256  
Telephone: 860.933.9495  
Facsimile: 866.477.1120  
Email: [doug@lawyer.com](mailto:doug@lawyer.com)

    //s// Craig C. Fishbein  
Craig C. Fishbein, Esq.  
(ct25142)  
FISHBEIN LAW FIRM, LLC  
100 South Main Street  
P.O. Box 363  
Wallingford, Connecticut 06492  
Telephone: 203.265.2895  
Facsimile: 203.294.1396  
E-mail: [ccf@fishbeinlaw.com](mailto:ccf@fishbeinlaw.com)

    //s// Cameron L. Atkinson  
Cameron L. Atkinson, Esq.  
(ct31219)  
ATKINSON LAW, LLC  
122 Litchfield Rd., Ste. 2  
P.O. Box 340  
Harwinton, CT 06791  
Telephone: 203.677.0782  
Facsimile: 203.672.6551  
Email: [catkinson@atkinsonlawfirm.com](mailto:catkinson@atkinsonlawfirm.com)

*Attorneys for the Plaintiff*

**CERTIFICATION OF SERVICE**

The undersigned hereby certifies that, on the foregoing date, a copy of the foregoing was filed electronically and served by mail on anyone unable to accept electronic filing. Notice of this filing will be sent by email to all parties and counsel of record who have appeared by operation of the Court's electronic filing system or by mail to anyone unable to accept electronic filing. Parties may access this filing through the Court's system.

/s/ Cameron L. Atkinson /s/